

# Transport & Trade connectivity in the age of pandemics: Project closing event

UNECE/CEFACT Contribution

June 20th 2022

**Sue Probert**

Chair, UN/CEFACT

[suesiprobert@live.com](mailto:suesiprobert@live.com)

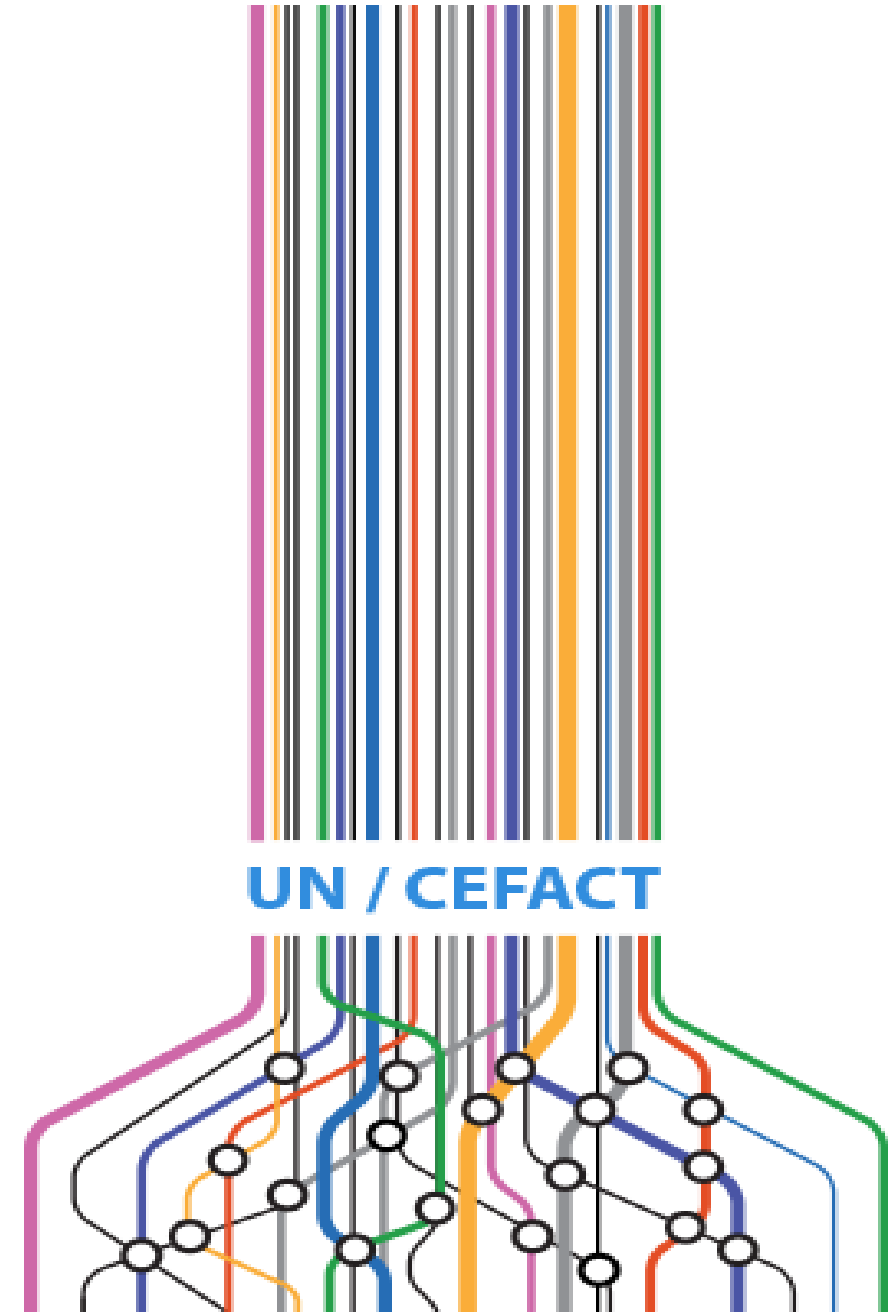



# UN/CEFACT

## Objectives

- Simple, transparent and effective processes for global business
- Efficient and automated exchange of information

## Outputs

- Global Trade Facilitation and Electronic Business Recommendations and Standards

## Means

- Public Private Sector Partnership
  - over 1000 experts from government and business
- Experts meet via internet every week plus two Face-to-Face Forums per year (hopefully)

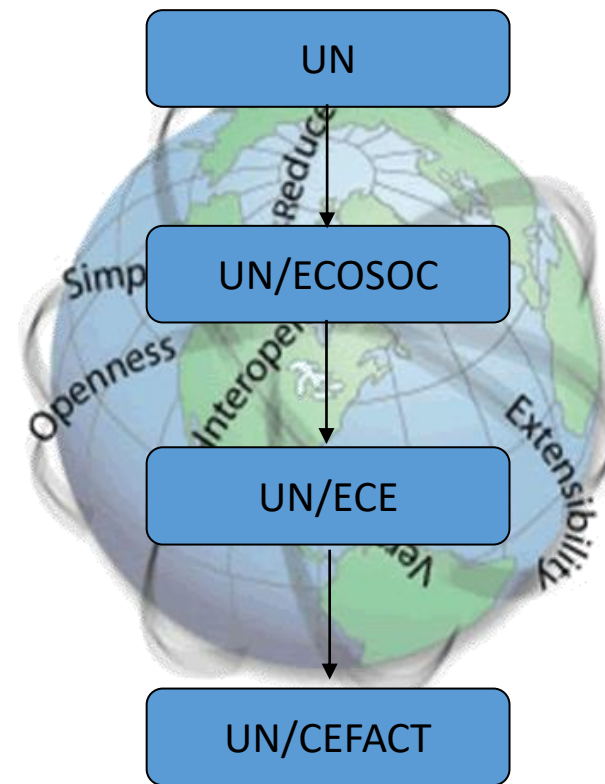

**Global Remit**



# Cooperation / Collaboration

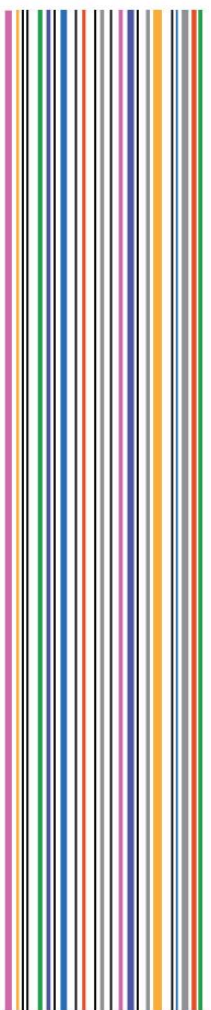

UN / CEFACT



EEC

EU  
DG-MOVE  
DG-TAXUD  
DG-MARE  
DG-DEVCO  
DG-DIGIT  
...

ISO  
IEC  
ITU  
WTO  
ITC  
IATA  
WCO  
OECD

GS1  
IPCSA  
PROTECT  
FIATA  
SMDG  
...



# One link in a global supply chain

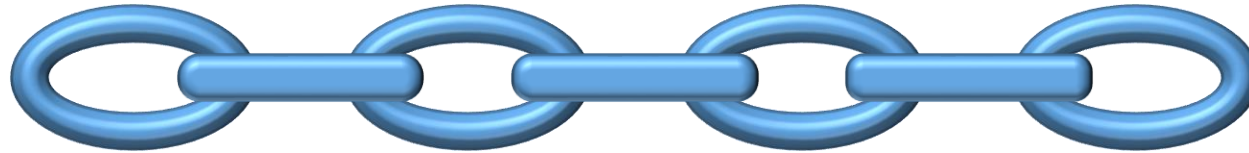

- Most dematerialization projects are only looking at one sectoral view
  - Almost all sectoral views are just one part of a global supply chain
  - The international supply chain is very complex (multiple actors and multiple relations in data exchanges)
- A holistic view and approach are needed
  - Information will not be related purely to goods or purely to transport or purely to regulatory
  - There are clear links between the information in each part of the global supply chain
- UN/CEFACT deliverables all take this holistic approach

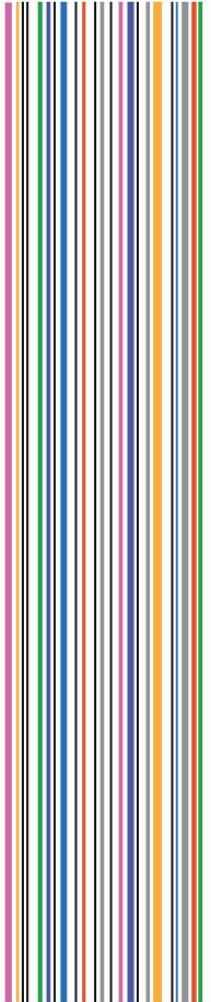

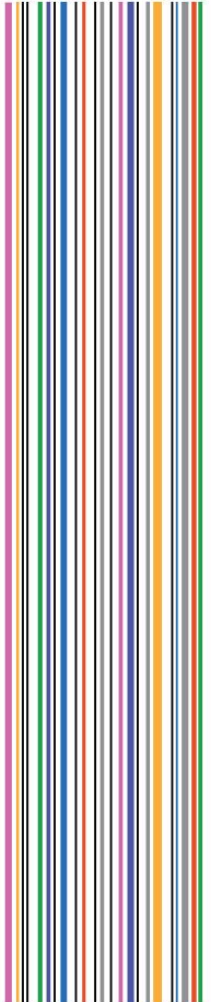

# UNTTC

## Transport & Trade Connectivity in the age of pandemics

- UN New York launched **COVID-19 initiative to encourage exchange of digitised electronic data** rather than paper documents in transport contract related data exchanges
- **UNECE and UN/CEFACT joint contribution:**
  - Cross-modal project to develop modal guides on reuse of the UN/CEFACT MMT Reference Data Model to support digitised data exchanges between transport modes
  - **7 Heads of Delegation** supported the Project  
(Germany, Spain, Greece, Russia, Italy, US and Ukraine)

# Phase 2 - Modal Specific Customisation



Air Freight



Road Freight

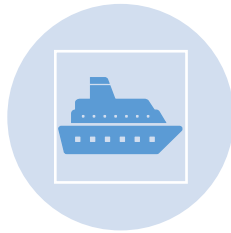

Sea Freight



Rail



Inland Waterway  
(tbc)



- Analysis of the CIM/SMGS ECN data structure in preparation for the mapping to IFTM subset
- Identified potential issue for mapping between the railway ECN and IFTM due to different structural representation
- Open discussion to describe and understand the issue
- Proposals for the next phase to reach a mapping exercise
  - Rearrange the structure of the railway ECN in the manner of MMT for seamless mappings and multimodal interoperability
  - Map only the possible data elements for the purpose of achieving multimodality

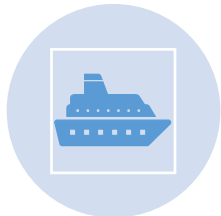

- Maritime specific subset of MMT created and re-used to model the **Ocean Bill of Lading**
- Project calls concluded last week on this work, results to be published good basis for industry eBill of Lading projects

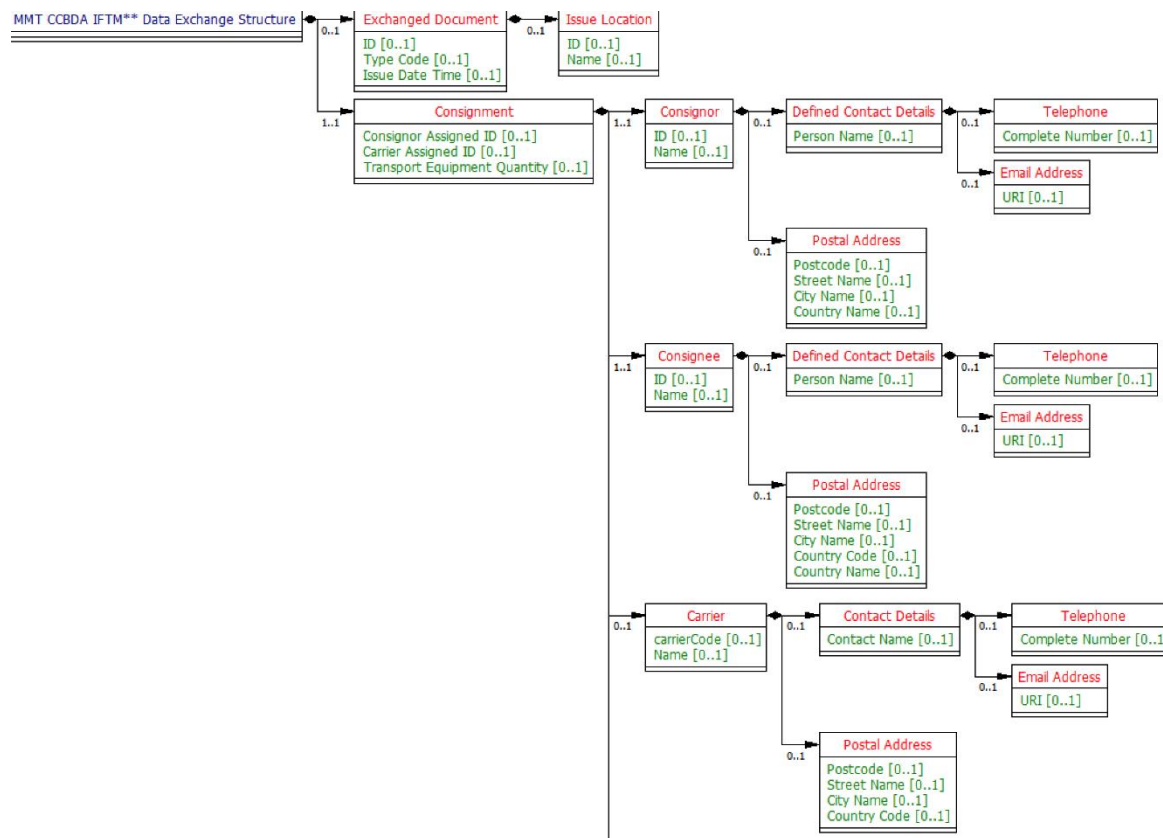





# Road Freight

e-CMR model: CMR Convention data, taken into account

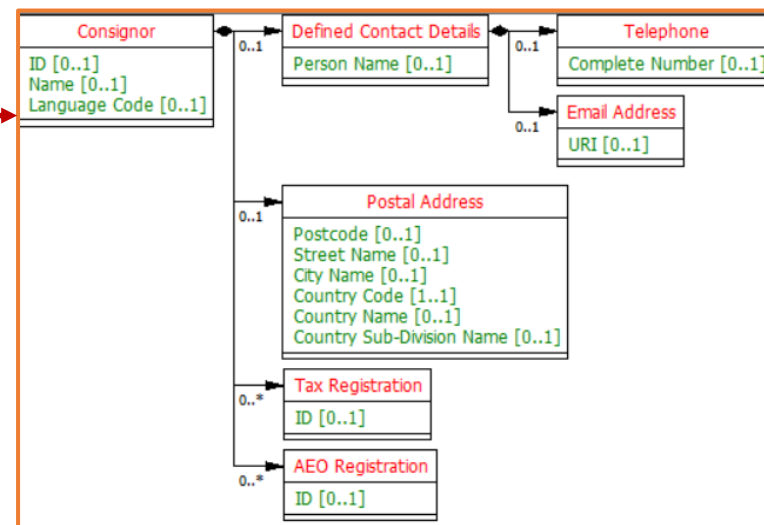

Each object in the eCMR structure has a unique Dictionary Entry Name plus a business short name for readability.

Based upon the UN/CEFACT Core Component Library (CCL), the MultiModal Transport Reference Data Model (MMT) and the Supply Chain Reference Data Model (SCRDM).



# Inter Modal Matrix with MMT as Reference Model (Auto-generated)

	C	D	E	F	G	H	I	J	K	L	M	N	O
1	<b>BN</b>	<b>FIATA Bill</b>	<b>CIM-SMGS</b>	<b>CIM-SMGS URL</b>	<b>Wagon List</b>	<b>River B/L</b>	<b>Maritime B/L</b>	<b>eCMR</b>	<b>EFTI DR FEB2021</b>	<b>EFTI DG to</b>	<b>Air Waybill</b>	<b>Air CSD</b>	<b>Air DG</b>
2	BN	FIATA Bill	CIM-SMGS Co	CIM-SMGS Co	Wagon list; Co	River Bill of Lading	Maritime Bl	eCMR MMT; R	eFTI DESCopy	MMT Cont	Air Waybill	CSD; D21	DG Decla
3	MMT CCBDA IFTM** Data Exchange Structure	X	X	X	X	X	X	X	X	X	X	X	X
4	Exchanged Document Context							X					
10	Exchanged Document	X	X	X	X	X	X	X			X	X	X
11	ID	X	X	X	X	X	X	X			X	X	X
12	Name												
13	Type Code					X	X	X			X	X	X
14	Issue Date Time	X	X	X	X	X	X	X			X	X	X
15	Remark							X					
16	Original Issued Quantity	X				X							
17	Copy Issued Quantity	X				X							
18	Purpose Code		X	X							X	X	X
19	Sender Assigned ID		X	X									
20	Recipient Assigned ID		X	X									
21	Version ID		X										
22	Note		X	X				X				X	
23	Subject Text							X					
24	Content Code							X					
25	Content Text		X	X				X				X	
26	Subject Code							X				X	
27	Reference Document		X	X									
28	Type Code		X	X									
29	Issue Location	X				X	X	X			X		X
30	ID	X				X	X	X			X		X
31	Name	X				X	X	X			X		X
32	Country Code	X						X					
33	Contractual Clause	X	X	X							X		
34	ID	X									X		
35	Content Text	X	X	X							X		
36	Air Waybill Consignor Signatory Authentication	X	X	X	X						X		
37	Actual Date Time	X	X	X							X		

# Thank You

- All UNECE and UN/CEFACT Recommendations, codes, standards and publications are available for free on our website at: [www.unece.org/cefact/](http://www.unece.org/cefact/)
- All experts are welcome to join the standards development work free of charge

**For further information:**

[suesi.probert@live.com](mailto:suesi.probert@live.com)