

# An Advanced Guide to Trade Policy Analysis: The Structural Gravity Model

Yoto V. Yotov,  
Roberta Piermartini,  
José-Antonio Monteiro,  
and Mario Larch



**What is *An Advanced Guide to Trade Policy Analysis*?**

*An Advanced Guide to Trade Policy Analysis* aims to help researchers and policymakers update their knowledge of quantitative economic methods and data sources for trade policy analysis.

**Using this guide**

The guide explains analytical techniques, reviews the data necessary for analysis and includes illustrative applications and exercises.

**Find out more**

Website: <http://vi.unctad.org/tpa>

# An Advanced Guide to Trade Policy Analysis: The Structural Gravity Model

# CONTENTS

---

Authors	3
Acknowledgments	3
Disclaimer	4
Introduction	5
A. The gravity model: a workhorse of applied international trade analysis	5
B. Using this guide	6
<b>CHAPTER 1: PARTIAL EQUILIBRIUM TRADE POLICY ANALYSIS WITH STRUCTURAL GRAVITY</b>	<b>9</b>
A. Overview and learning objectives	11
B. Analytical tools	12
1. Structural gravity: from theory to empirics	12
2. Gravity estimation: challenges, solutions and best practices	17
3. Gravity estimates: interpretation and aggregation	28
4. Gravity data: sources and limitations	32
C. Applications	40
1. Traditional gravity estimates	41
2. The “distance puzzle” resolved	45
3. Regional trade agreements effects	49
D. Exercises	55
1. Estimating the effects of the WTO accession	55
2. Estimating the effects of unilateral trade policy	56

Appendices	57
Appendix A: Structural gravity from supply side	57
Appendix B: Structural gravity with tariffs	60
Appendix C: Databases and data sources links summary	63
<b>Chapter 2: General equilibrium trade policy analysis with structural gravity</b>	<b>67</b>
A. Overview and learning objectives	69
B. Analytical tools	70
1. Structural gravity: general equilibrium context	70
2. Standard approach to general equilibrium analysis with structural gravity	88
3. A general equilibrium gravity analysis with the Poisson Pseudo Maximum Likelihood (GEPPML)	95
C. Applications	102
1. Trade without borders	103
2. Impact of regional trade agreements	111
D. Exercises	117
1. Calculating the general equilibrium impacts of removing a specific border	117
2. Calculating the general equilibrium impacts of a regional trade agreement	118
Appendices	119
Appendix A: Counterfactual analysis using supply-side gravity framework	119
Appendix B: Structural gravity with sectors	121
Appendix C: Structural gravity system in changes	126
References	131

## AUTHORS

---

### **Yoto V. Yotov**

Drexel University, CESifo and ERI-BAS

### **Roberta Piermartini**

Economic Research and Statistics Division, World Trade Organization

### **José-Antonio Monteiro**

Economic Research and Statistics Division, World Trade Organization

### **Mario Larch**

University of Bayreuth, CESifo, ifo Institute, and GEP at University of Nottingham

## Acknowledgments

The authors would like to thank Michela Esposito for her comments and valuable research assistance. They also would like to thank Delina Agnosteva, James Anderson, Richard Barnett, Davin Chor, Gabriel Felbermayr, Benedikt Heid, Russell Hillberry, Lou Jing, Ma Lin, Antonella Liberatore, Andreas Maurer, Jurgen Richtering, Stela Rubinova, Serge Shikher, Costas Syropoulos, Robert Teh, Thomas Verbeet, Mykyta Vesselovsky, Joschka Wanner, Thomas Zylkin, as well as the seminar and workshop participants at the ifo Institute, the World Trade Organization, the World Bank, the U.S. International Trade Commission, Global Affairs Canada, the University of Ottawa, the Kiel Institute for the World Economy, the Tsenov Academy of Economics, and the National University of Singapore for helpful suggestions and discussions. Thanks also go to Vlasta Macku (UNCTAD Virtual Institute) for her continuous support to this project and her role in initiating this inter-organizational cooperation.

The production of this book was managed by WTO Publications. Anthony Martin has edited the text. The website was developed by Susana Olivares.

## DISCLAIMER

---

The designations employed in UNCTAD and WTO publications, which are in conformity with United Nations practice, and the presentation of material therein do not imply the expression of any opinion whatsoever on the part of the United Nations Conference on Trade and Development or the World Trade Organization concerning the legal status of any country, area or territory or of its authorities, or concerning the delimitation of its frontiers. The responsibility for opinions expressed in studies and other contributions rests solely with their authors, and publication does not constitute an endorsement by the United Nations Conference on Trade and Development or the World Trade Organization of the opinions expressed. Reference to names of firms and commercial products and processes does not imply their endorsement by the United Nations Conference on Trade and Development or the World Trade Organization, and any failure to mention a particular firm, commercial product or process is not a sign of disapproval.

# INTRODUCTION

---

## A. The gravity model: a workhorse of applied international trade analysis

Quantitative and detailed trade policy information and analysis are more necessary now than they have ever been. In recent years, globalization and, more specifically, trade opening have become increasingly contentious. It is, therefore, important for policy-makers and other trade policy stakeholders to have access to detailed, reliable information and analysis on the effects of trade policies, as this information is needed at different stages of the policy-making process.

Often referred to as the workhorse in international trade, the gravity model is one of the most popular and successful frameworks in economics. Hundreds of papers have used the gravity equation to study and quantify the effects of various determinants of international trade. There are at least five compelling arguments that, in combination, may explain the remarkable success and popularity of the gravity model.

- First, the gravity model of trade is **very intuitive**. Using the metaphor of Newton's Law of Universal Gravitation, the gravity model of trade predicts that international trade (gravitational force) between two countries (objects) is directly proportional to the product of their sizes (masses) and inversely proportional to the trade frictions (the square of distance) between them.
- Second, the gravity model of trade is a **structural model with solid theoretical foundations**. This property makes the gravity framework particularly appropriate for counterfactual analysis, such as quantifying the effects of trade policy.
- Third, the gravity model represents a **realistic general equilibrium environment** that simultaneously accommodates multiple countries, multiple sectors, and even firms. As such, the gravity framework can be used to capture the possibility that markets (sectors, countries, etc.) are linked and that trade policy changes in one market will trigger ripple effects in the rest of the world.
- Fourth, the gravity setting is a **very flexible structure** that can be integrated within a wide class of broader general equilibrium models in order to study the links between trade and labour markets, investment, the environment, etc.
- Finally, one of the most attractive properties of the gravity model is its **predictive power**. Empirical gravity equations of trade flows consistently deliver a remarkable fit of between 60 and 90 percent with aggregate data as well as with sectoral data for both goods and services.<sup>1</sup>



Capitalizing on the appealing properties of the gravity model, this *Advanced Guide to Trade Policy Analysis* complements and is best used in conjunction with the *Practical Guide to Trade Policy Analysis* published in 2012. In particular, the *Advanced Guide* presented in Chapter 3 a brief overview of the theoretical foundation of gravity models, possible estimation methods, and advanced modelling issues, such as the handling of zero-trade flows and calculation of tariff equivalents of non-tariff barriers. The *Practical Guide* also discussed data sources for gravity analysis and explains how to build a gravity database.

Chapter 1 of this *Advanced Guide* reconsiders some of these issues, including data challenges and sources, but also integrates the latest developments in the empirical gravity literature by proposing six recommendations to obtain reliable estimates of the **partial equilibrium effects** of bilateral and non-discriminatory trade policies within the same comprehensive, and theoretically-consistent econometric specification of the structural gravity model.

In addition, unlike the *Practical Guide*, which only presented in Chapter 5 what Computable General Equilibrium models are and when they should be used, Chapter 2 of this *Advanced Guide* offers a deep analysis of the structural relationships underlying the general equilibrium gravity system, and how they can be exploited to make trade policy inferences. In particular, Chapter 2 presents standard procedures to perform counterfactual analysis with the structural gravity model and outlines the latest methods developed in the literature to obtain theory-consistent **general equilibrium effects** of trade policy with a simple procedure that can be performed in most statistical software packages. Chapter 2 further shows how the structural gravity model presented in this *Advanced Guide* can be integrated within a larger class of general equilibrium models, such as a dynamic gravity model.

## B. Using this Guide

This *Advanced Guide* is targeted at economists with advanced training and experience in applied research and analysis. In particular, on the economics side, advanced knowledge of international trade theory and policy is required, while on the empirical side, the prerequisite is familiarity with work on databases and with the use of STATA software. The reader with limited experience with STATA may wish to first review the applications and complete the exercises proposed in the *Practical Guide to Trade Policy Analysis*.

The Guide comprises two chapters. Both chapters start with a brief introduction providing an overview of the contents and setting out the learning objectives. Each chapter is further divided into two main parts. The first part introduces a number of theoretical concepts and analytical tools, and explains their economic logic. The first part of Chapter 1 also includes a discussion on data sources. The second part of both chapters describes how the analytical tools can be applied in practice, showing how data can be processed to analyse the effects of the trade policies on trade flows output, expenditures, real GDP and welfare. Each of these applications has been designed only for a pedagogical purpose.

The software used for partial and general equilibrium analysis with the structural gravity model is STATA software. While the presentation of these applications in the chapters can stand alone, the files with the corresponding STATA commands and the relevant data can be found on the *Practical Guide to Trade Policy Analysis* website: <http://vi.unctad.org/tpa>. A general folder entitled “Advanced Guide to Trade Policy Analysis” is divided into sub-folders which correspond to each chapter (e.g. “Advanced Guide to Trade Policy Analysis\Chapter1”). Within each of these sub-folders, the reader will find datasets, applications and exercises. Detailed explanations can be found in the file “readme.pdf” available on the website.

## Endnote

- 1 Head and Mayer (2014) offer representative estimates and evidence for the empirical success of gravity with aggregate data. Anderson and Yotov (2010) present and discuss sectoral gravity estimates with goods trade. Anderson et al. (2015a) demonstrate that gravity works very well with services sectoral data. Finally, Aichele et al. (2014) estimate sectoral gravity for agriculture, mining, manufacturing goods and services.



# CHAPTER 1: Partial equilibrium trade policy analysis with structural gravity<sup>1</sup>

---

## TABLE OF CONTENTS

A. Overview and learning objectives	11
B. Analytical tools	12
1. Structural gravity: from theory to empirics	12
2. Gravity estimation: challenges, solutions and best practices	17
3. Gravity estimates: interpretation and aggregation	28
4. Gravity data: sources and limitations	32
C. Applications	40
1. Traditional gravity estimates	41
2. The “distance puzzle” resolved	45
3. Regional trade agreements effects	49
D. Exercises	55
1. Estimating the effects of WTO accession	55
2. Estimating the effects of unilateral trade policy	56
Appendices	57
Appendix A: Structural gravity from supply side	57
Appendix B: Structural gravity with tariffs	60
Appendix C: Databases and data sources links summary	63
Endnotes	65

## LIST OF FIGURES

Figure 1	Gravity model's strong theoretical foundations	12
----------	--	----

## LIST OF TABLES

Table 1	Traditional gravity estimates	42
Table 2	A simple solution of the "distance puzzle" in trade	47
Table 3	Estimating the effects of regional trade agreements	51

## LIST OF BOXES

Box 1	Analogy between the Newtonian theory of gravitation and gravity trade model	17
Box 2	In the absence of panel trade data	26

## A. Overview and learning objectives

Despite solid theoretical foundations and remarkable empirical success, the empirical gravity equation is still often applied a-theoretically and without account for important estimation challenges that may lead to biased and even inconsistent gravity estimates. The objective of this chapter is to serve as a practical guide for estimating the effects of trade policies (and other determinants of bilateral trade) with the structural gravity model.

The first part of this chapter will present a brief overview of the evolution of gravity theory over time and review the theoretical foundations of the Armington-Constant Elasticity of Substitution (CES) version of the structural gravity model. Importantly, the Armington-CES framework is used as a representative theoretical setting for a wide family of trade models that all lead to the same empirical gravity specification. Next, the main challenges faced when estimating the gravity model will be discussed along with the solutions that have been proposed in the trade literature to address them. Drawing from the latest developments in the empirical gravity literature, six recommendations will be formulated to obtain reliable partial equilibrium estimates of the effects of bilateral and non-discriminatory trade policies within the same comprehensive and theoretically-consistent econometric specification. Interpretation of the partial equilibrium gravity estimates and methods to consistently aggregate bilateral trade costs will then be discussed. Finally, data sources for gravity analysis, including bilateral trade flows and trade costs, will be provided.

Once familiarized with these theoretical concepts and analytical tools, a series of empirical applications, demonstrating the usefulness, validity and applicability of the recommendations proposed will be presented. Specifically, instructions will be provided on how to estimate a structural gravity model in order to assess the partial equilibrium effects of traditional gravity variables (e.g. distance, common language ...), globalization, and regional trade agreements (RTAs) (as a representative form of bilateral trade policy).

Two exercises are provided at the end of the chapter. Data and STATA do-files for the solution of these exercises can be downloaded from the website.

In this chapter, you will learn:

- How the structural gravity model is derived;
- Where to find the data needed to estimate econometrically the structural gravity model;
- What are the main measurement issues associated with gravity data;
- What are the main econometric issues associated with the estimation of the structural gravity model and how to address them;
- How to econometrically estimate the structural gravity model;
- How to interpret and consistently aggregate gravity estimates.

After reading this chapter, with good econometric knowledge, and familiarity with STATA, you will be able to estimate using STATA software a theoretically-consistent structural gravity model and assess the effects of trade policies (and other determinants) on bilateral trade, while interpreting the econometric results with key caveats in mind.

## B. Analytical tools

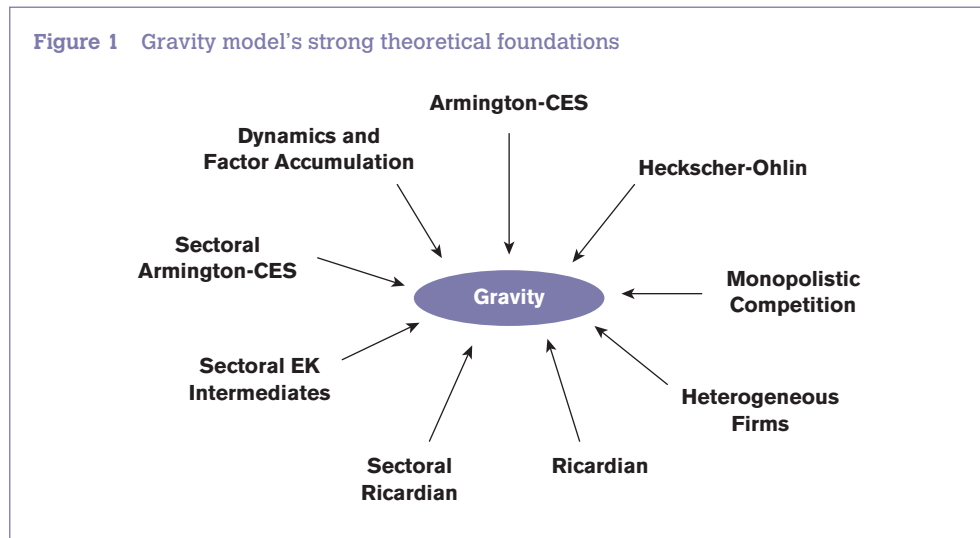
### 1. Structural gravity: from theory to empirics

#### (a) Evolution of gravity theory over time

According to Newton's Law of Universal Gravitation, any particle in the universe attracts any other particle thanks to a force that is directly proportional to the product of their masses and inversely proportional to the square of the distance between them. Applied to international trade, Newton's Law of Gravity implies that, just as particles are mutually attracted in proportion to their sizes and proximity, countries trade in proportion to their respective market size (e.g. gross domestic products) and proximity.

The initial applications of Newton's Law of Gravitation to economics are *a-theoretical*. Prominent examples include Ravenstein (1885) and Tinbergen (1962), who used gravity to study immigration and trade flows, respectively. Anderson (1979) is the first to offer a *theoretical* economic foundation for the gravity equation under the assumptions of product differentiation by place of origin and Constant Elasticity of Substitution (CES) expenditures. Another early contribution to gravity theory is Bergstrand (1985).

Despite these theoretical developments and its solid empirical performance, the gravity model of trade struggled to make much impact in the profession until the late 1990s and early 2000s. Arguably, the most influential structural gravity theories in economics are those of Eaton and



Kortum (EK) (2002), who derived gravity on the supply side as a Ricardian structure with intermediate goods, and Anderson and van Wincoop (2003), who popularized the Armington-CES model of Anderson (1979) and emphasized the importance of the general equilibrium effects of trade costs.

The academic interest in the gravity model was recently stimulated by the influential work of Arkolakis et al. (2012), who demonstrated that a large class of models generate *isomorphic* gravity equations which preserves the gains from trade. As depicted in Figure 1, the gains from trade are invariant to a series of alternative micro-foundations including a single economy model with monopolistic competition (Anderson, 1979; Anderson and van Wincoop, 2003); a Heckscher-Ohlin framework (Bergstrand, 1985; Deardoff, 1998); a Ricardian framework (Eaton and Kortum, 2002); entry of heterogeneous firms, selection into markets (Chaney, 2008; Helpman et al., 2008); a sectoral Armington-model (Anderson and Yotov, 2016); a sectoral Ricardian model (Costinot et al., 2012; Chor, 2010); a sectoral input-output linkages gravity model based on Eaton and Kortum (2002) (Caliendo and Parro, 2015), and a dynamic framework with asset accumulation (Olivero and Yotov, 2012, Anderson et al. 2015C, and Eaton et al., 2016). Most recently, Allen et al. (2014) established the universal power of gravity by deriving sufficient conditions for the existence and uniqueness of the trade equilibrium for a wide class of general equilibrium trade models.

## (b) Review of the structural gravity model

One of the main advantages of the structural gravity model is that it delivers a tractable framework for trade policy analysis in a multi-country environment. Accordingly, the model reviewed in this *Advanced Guide* considers a world that consists of  $N$  countries, where each economy produces a variety of goods (i.e. goods are differentiated by place of origin (Armington, 1969)) that is traded with the rest of the world. The supply of each good is fixed to  $Q_i$ , and the factory-gate price for each variety is  $p_i$ . Thus, the value of domestic production in a representative economy is defined as  $Y_i = p_i Q_i$ , where  $Y_i$  is also the nominal income in country  $i$ . Country  $i$ 's aggregate expenditure is denoted by  $E_i$ . Aggregate expenditure can also be expressed in terms of nominal income by  $E_i = \phi_i Y_i$ , where  $\phi_i > 1$  shows that country  $i$  runs a trade deficit, while  $1 > \phi_i > 0$  reflects a trade surplus. Similar to Dekle et al. (2007; 2008), trade deficits and surpluses are treated as exogenous. For brevity's sake, the time dimension  $t$  is omitted in the derivation of the structural gravity model. In addition, the structural gravity model presented below is derived from the demand side. However, as demonstrated in Appendix A, the same gravity system can be derived from the supply side.

On the demand side, consumer preferences are assumed to be homothetic, identical across countries, and given by a CES-utility function for country  $j$ :<sup>2</sup>

$$\left\{ \sum_i \alpha_i \frac{1-\sigma}{\sigma} c_{ij}^{\frac{\sigma-1}{\sigma}} \right\}^{\frac{\sigma}{\sigma-1}} \quad (1-1)$$

where  $\sigma > 1$  is the elasticity of substitution among different varieties, i.e. goods from different countries,  $\alpha_i > 0$  is the CES preference parameter, which will remain treated as an exogenous taste parameter and  $c_{ij}$  denotes consumption of varieties from country  $i$  in country  $j$ .



Consumers maximize equation (1-1) subject to the following standard budget constraint:

$$\sum_i p_{ij} c_{ij} = E_j \quad (1-2)$$

Equation (1-2) ensures that the total expenditure in country  $j$ ,  $E_j$ , is equal to the total spending on varieties from all countries, including  $j$ , at delivered prices  $p_{ij} = p_i t_{ij}$ , which are defined conveniently as a function of factory-gate prices in the country of origin,  $p_i$ , marked up by bilateral trade costs,  $t_{ij} \geq 1$ , between trading partners  $i$  and  $j$ . Throughout the analysis, the bilateral trade costs are defined as iceberg costs, as is standard in the trade literature (Samuelson, 1952). In order to deliver one unit of its variety to country  $j$ , country  $i$  must ship  $t_{ij} \geq 1$  units, i.e.  $1/t_{ij}$  of the initial shipment melts “en route”. While the Armington model presumes that all bilateral trade costs are variable, in principle, structural gravity can also accommodate fixed trade costs (Melitz, 2003). The iceberg trade costs metaphor can also be extended to accommodate fixed costs with the interpretation that “a chunk of the iceberg breaks off as it parts from the mother glacier” (Anderson, 2011).

Solving the consumer’s optimization problem yields the expenditures on goods shipped from origin  $i$  to destination  $j$  as:<sup>3</sup>

$$X_{ij} = \left( \frac{\alpha_i p_i t_{ij}}{P_j} \right)^{(1-\sigma)} E_j \quad (1-3)$$

where  $X_{ij}$  denotes trade flows from exporter  $i$  to destination  $j$  and, for now,  $P_j$  can be interpreted as a CES consumer price index:

$$P_j = \left[ \sum_i (\alpha_i p_i t_{ij})^{1-\sigma} \right]^{\frac{1}{1-\sigma}} \quad (1-4)$$

Given that the elasticity of substitution is greater than one,  $\sigma > 1$ , equation (1-3) captures several intuitive relationships. In particular, expenditure in country  $j$  on goods from source  $i$ ,  $X_{ij}$ , is:

- (i) proportional to total expenditure,  $E_j$ , in destination  $j$ . The simple intuition is that, all else equal, larger/richer markets consume more of all varieties, including goods from  $i$ .
- (ii) inversely related to the (delivered) prices of varieties from origin  $i$  to destination  $j$ ,  $p_{ij} = p_i t_{ij}$ . This is a direct reflection of the *law of demand*, which depends not only on factory-gate price  $p_i$  but also on bilateral trade cost  $t_{ij}$  between partners  $i$  and  $j$ . The ideal combination that favours bilateral trade is an efficient producer, characterized by low factory-gate price, and low bilateral trade cost between countries  $i$  and  $j$ .

- (iii) directly related to the CES price aggregator  $P_j$ . This relationship reflects the substitution effects across varieties from different countries. All else equal, the relatively more expensive the rest of the varieties in the world are, the more consumers in country  $j$  will substitute away from them and toward the goods from country  $i$ .
- (iv) contingent on the elasticity of substitution  $\sigma$ , when factory-gate prices or the aggregate CES prices (or in the combination of those as a relative price) change. All else equal, a higher elasticity of substitution will magnify the trade diversion effects from the more expensive commodities to the cheaper ones.

The final step in the derivation of the structural gravity model is to impose market clearance for goods from each origin:

$$Y_i = \sum_j \left( \frac{\alpha_i p_i t_{ij}}{P_j} \right)^{1-\sigma} E_j \quad (1-5)$$

Equation (1-5) states that, at delivered prices (because part of the shipments melt “en route”), the value of output in country  $i$ ,  $Y_i$ , should be equal to the total expenditure of this country’s variety in all countries in the world, including  $i$  itself. To see this intuition more clearly, note that the right-hand-side expression in equation (1-5) can be replaced with the sum of all bilateral shipments from  $i$  as defined in equation (1-3), so that  $Y_i \equiv \sum_j X_{ij} \forall j$ .

Defining  $Y \equiv \sum_i Y_i$  and dividing equation (1-5) by  $Y_i$ , the terms can be rearranged to obtain:

$$(\alpha_i p_i)^{1-\sigma} = \frac{\frac{Y_i}{Y}}{\sum_j \left( \frac{t_{ij}}{P_j} \right)^{1-\sigma} \frac{E_j}{Y}} \quad (1-6)$$

Following Anderson and van Wincoop (2003), the term in the denominator of equation (1-6) can be defined as  $\Pi_i^{1-\sigma} \equiv \sum_j \left( t_{ij}/P_j \right)^{1-\sigma} E_j/Y$ , and be substituted into equation (1-6):

$$(\alpha_i p_i)^{1-\sigma} = \frac{Y_i/Y}{\Pi_i^{1-\sigma}} \quad (1-7)$$

Using equation (1-7) to substitute for the power transform  $(\alpha_i p_i)^{1-\sigma}$  in equations (1-3) and (1-4), and combining the definition of  $\Pi_i^{1-\sigma}$  with the resulting expressions that correspond to equations (1-3) and (1-4), the structural gravity system is given by:

$$X_{ij} = \frac{Y_i E_j}{Y} \left( \frac{t_{ij}}{\Pi_i P_j} \right)^{1-\sigma} \quad (1-8)$$

$$\Pi_i^{1-\sigma} = \sum_j \left( \frac{t_{ij}}{P_j} \right)^{1-\sigma} \frac{E_j}{Y} \quad (1-9)$$

$$P_j^{1-\sigma} = \sum_i \left( \frac{t_{ij}}{\Pi_i} \right)^{1-\sigma} \frac{Y_i}{Y} \quad (1-10)$$

### (c) Structural decomposition of gravity: size vs. trade cost

Equation (1-8), representing the theoretical gravity equation that governs bilateral trade flows, can be conveniently decomposed into two terms: (i) a *size term*,  $Y_i E_j / Y$ , and a *trade cost term*,  $\left( t_{ij} / (\Pi_i P_j) \right)^{1-\sigma}$ :

- (i) The intuitive interpretation of the *size term*,  $Y_i E_j / Y$ , is as the hypothetical level of frictionless trade between partners  $i$  and  $j$  if there were no trade costs.<sup>4</sup> Mechanically, this can be shown by eliminating bilateral trade frictions (i.e. setting  $t_{ij} = 1$ ), and re-deriving the gravity system. Intuitively, a frictionless world implies that consumers will face the same price for a given variety regardless of their physical location and that their expenditure share on goods from a particular country will be equal to the share of production in the source country in the global economy (i.e.  $X_{ij} / E_j = Y_i / Y$ ). Overall, the size term already carries some very useful information regarding the relationship between country size and bilateral trade flows:<sup>5</sup> namely, large producers will export more to all destinations; big/rich markets will import more from all sources; and trade flows between countries  $i$  and  $j$  will be larger the more similar in size the trading partners are.
- (ii) The natural interpretation of the *trade cost term*,  $\left( t_{ij} / (\Pi_i P_j) \right)^{1-\sigma}$ , is that it captures the total effects of trade costs that drive a wedge between realized and frictionless trade. The trade cost term consists of three components:
  - (1) Bilateral trade cost between partners  $i$  and  $j$ ,  $t_{ij}$ , is typically approximated in the literature by various geographic and trade policy variables, such as bilateral distance, tariffs and the presence of regional trade agreements (RTAs) between partners  $i$  and  $j$ .
  - (2) The structural term  $P_j$ , coined by Anderson and van Wincoop (2003) as inward multilateral resistance represents importer  $j$ 's ease of market access.
  - (3) The structural term  $\Pi_i$ , defined as outward multilateral resistances by Anderson and van Wincoop (2003), measures exporter  $i$ 's ease of market access.

As will be discussed in more details in section B.1 of Chapter 2, the multilateral resistances are the vehicles that translate the initial, partial equilibrium effects of trade policy at the bilateral level to country-specific effects on consumer and producer prices. The direct effects do give the initial impact effects of trade costs on trade flows, while the general equilibrium trade costs also take into account the changes in prices, incomes and expenditures induced by trade cost changes. While this chapter focuses on the direct, partial effects of trade costs, chapter 2 deals with the general equilibrium trade costs.

### Box 1 Analogy between the Newtonian theory of gravitation and the gravity trade model

To see the remarkable resemblance between the trade gravity equation and the corresponding equation from physics, two terms,  $T_{ij}^{\theta}$  and  $\tilde{G}$  have to be defined in equation (1-8) as reported in the right-hand side of the table below.

<i>Newton's Law of Universal Gravitation</i>	<i>Gravity Trade Model</i>
$F_{ij} = G \frac{M_i M_j}{D_{ij}^{\theta}}$	$X_{ij} = \tilde{G} \frac{Y_i E_j}{T_{ij}^{\theta}}$
<p>where:</p> <ul style="list-style-type: none"> <li>- <math>F_{ij}</math>: gravitational force between objects <math>i</math> and <math>j</math></li> <li>- <math>G</math>: gravitational constant</li> <li>- <math>M_i</math>: object <math>i</math>'s mass</li> <li>- <math>M_j</math>: object <math>j</math>'s mass</li> <li>- <math>D_{ij}</math>: distance between objects <math>i</math> and <math>j</math></li> </ul>	<p>where:</p> <ul style="list-style-type: none"> <li>- <math>X_{ij}</math>: exports from countries <math>i</math> and <math>j</math></li> <li>- <math>\tilde{G}</math>: inverse of world production <math>\tilde{G} \equiv 1/Y</math></li> <li>- <math>Y_i</math>: country <math>i</math>'s domestic production</li> <li>- <math>E_j</math>: country <math>j</math>'s aggregate expenditure</li> <li>- <math>T_{ij}^{\theta}</math>: total trade costs between countries <math>i</math> and <math>j</math></li> </ul> $T_{ij}^{\theta} \equiv (t_{ij} / (\Pi_i \Pi_j))^{\sigma-1}$

Based on the metaphor of Newton's Law of Universal Gravitation, the gravity model of trade predicts that international trade (gravitational force) between two countries (objects) is directly proportional to the product of their sizes (masses) and inversely proportional to the trade frictions (the square of distance) between them.

## 2. Gravity estimation: challenges, solutions and best practices

Given the multiplicative nature of the structural gravity equation (1-8), and assuming that it holds in each period of time  $t$ , it is possible to log-linearize it and expand it with an additive error term,  $\varepsilon_{ij,t}$ :

$$\ln X_{ij,t} = \ln E_{j,t} + \ln Y_{i,t} - \ln Y_t + (1-\sigma) \ln t_{ij,t} - (1-\sigma) \ln P_{j,t} - (1-\sigma) \ln \Pi_{i,t} + \varepsilon_{ij,t} \quad (1-11)$$

Specification (1-11) is the most popular version of the empirical gravity equation, and it has been used routinely in the trade literature to study the effects of various determinants of bilateral trade. Hundreds of papers have used the gravity equation to study the effects of geography, demographics, RTAs, tariffs, exports subsidies, embargoes, trade sanctions, the World Trade Organization membership, currency unions, foreign aid, immigration, foreign direct investment, cultural ties, trust, reputation, mega sporting events (Olympic Games and World Cup), melting ice caps, etc. on international trade.

Despite the numerous applications of the gravity model and despite the great progress in the empirical gravity literature, many of the gravity estimates found in the existing literature still suffer biases and even inconsistency, which, as demonstrated in this section, can be avoided with some simple steps and stricter adherence to gravity theory.

This section begins with a discussion of the main challenges that need to be addressed in order to obtain reliable estimates with the structural gravity model. In addition, the solutions that have been proposed in the literature to address each of those challenges are reviewed and discussed. Capitalizing on the latest developments in the gravity literature, six recommendations to obtain reliable estimates of the structural gravity model are formulated. Finally, a comprehensive and theoretically-consistent estimating gravity specification that simultaneously identifies the effects of bilateral and unilateral non-discriminatory trade policy is proposed. Relevant examples of STATA commands are also presented throughout the section.

### (a) Challenges and solutions for estimating structural gravity models

Estimating the gravity model is subject to a number of modelling and econometric issues. This section reviews the eight main issues and discusses the relevant solutions that have been proposed in the literature to address them.

#### **Challenge 1: Multilateral resistances**

One obvious challenge with the estimation of gravity equation (1-11) is that the multilateral resistance terms  $P_{j,t}$  and  $\Pi_{i,t}$  are theoretical constructs and, as such, they are not directly observable by the researcher and/or by the policy maker. Baldwin and Taglioni (2006) emphasize the importance of proper control for the multilateral resistance terms by characterizing studies that fail to do that as committing the “Gold Medal Mistake”.

**Solutions to challenge 1:** The treatment of the multilateral resistance terms in gravity estimations has evolved over the years and researchers have proposed various solutions to this challenge.

- (i) In their original paper, Anderson and van Wincoop (2003) use iterative custom nonlinear least squares programming to account for the multilateral resistances in a static setting. Specifically, they first estimate the trade cost parameters without controlling for the multilateral resistances. Then, they use the estimated trade costs to construct an initial set of multilateral resistances. Then, they reestimate the gravity model using the initial multilateral resistances in the regression to obtain a new set of trade costs, which are used to construct a new set of multilateral resistances. The process is repeated until convergence, i.e. until the gravity estimates stop changing.
- (ii) Many researchers have used a reduced-form version of the custom treatment from Anderson and van Wincoop (2003), where the multilateral resistance terms are approximated by the so-called “remoteness indexes” constructed as functions of bilateral distance, and Gross Domestic Products (GDPs) (Wei, 1996; Baier and Bergstrand, 2009). Head and Mayer (2014) criticize such reduced-form approaches as they bear little resemblance to the theoretical counterpart of multilateral terms.
- (iii) An alternative approach to handle the multilateral resistances is to simply eliminate these terms by using appropriate ratios based on the structural gravity equation. Notable examples include Head and Ries (2001), Head et al. (2010), and Novy (2013) as discussed in Chapter 2.

- (iv) Another approach, advocated by Hummels (2001) and Feenstra (2016), that is able to overcome the computational difficulties of the custom programming from Anderson and van Wincoop (2003), while at the same time fully accounting for the multilateral resistance terms, consists in using *directional* (*exporter* and *importer*) fixed effects in cross-section estimations. More recently, Olivero and Yotov (2012) extend the cross-section recommendations from Hummels (2001) and Feenstra (2016), and demonstrate that the multilateral resistance terms should be accounted for by *exporter-time* and *importer-time* fixed effects in a dynamic gravity estimation framework with panel data. It should be noted that in addition to accounting for the unobservable multilateral resistance terms, the *exporter-time* and *importer-time* fixed effects will also absorb the size variables ( $E_{j,t}$  and  $Y_{i,t}$ ) from the structural gravity model as well as all other observable and unobservable country-specific characteristics, which vary across these dimensions, including various national policies, institutions, and exchange rates.

### Challenge 2: Zero trade flows

Starting with Tinbergen (1962) and continuing today, the ordinary least-squares (OLS) estimator has been the most widely used technique to estimate various versions of the gravity equation (1-11). A clear drawback of the OLS approach, however, is that it cannot take into account the information contained in the zero trade flows, because these observations are simply dropped from the estimation sample when the value of trade is transformed into a logarithmic form. The problem with the zeroes becomes more pronounced the more disaggregated the trade data are. It is especially severe for sectoral services trade due to the highly localized consumption and highly specialized production.

**Solutions to challenge 2:** Researchers have, over the years, proposed several approaches to handle the presence of zero trade flows.

- (i) One frequently applied and very convenient – but theoretically inconsistent – method is to just add a very small, and in fact completely arbitrary, value to replace the zero trade flows. As noted in Head and Mayer (2014), however, this approach should be avoided because the results depend on the units of measurement and the interpretation of the gravity coefficients as elasticities is lost.<sup>6</sup>
- (ii) Eaton and Tamura (1995) and Martin and Pham (2008) propose the use of the Tobit estimator as an econometric solution to the presence of zeroes. However, gravity theory is silent about the determination of the Tobit thresholds, causing a disconnect between estimation and theory. In practice, the Tobit model would apply to a situation where small values of trade are rounded to zero or actual zero trade might reflect desired negative trade.
- (iii) The difficulty associated with the Tobit model is overcome by Helpman et al. (2008) who propose a theoretically-founded two-step selection process, where exporters must absorb some fixed costs to enter a market. Thus, fixed costs provide an intuitive economic explanation for the zero trade flows to bridge theory and empirics. The Helpman, Melitz and Rubinstein (HMR) model is estimated in two stages: (i) a first-stage Probit estimation, which determines the probability to export, and (ii) a second-stage OLS estimation based on the positive sample of trade

flows that also accounts for selection into exporting due to fixed costs of exporting. Some challenges with the HMR estimation are that it is hard to find good exclusion restrictions for the first-stage Probit estimation and/or the need for custom programming when identification relies on functional form. Additional difficulties with the HMR approach arise for panel data estimations and when dynamic considerations are taken into account.

- (iv) Egger et al. (2011) suggest a two-part gravity model that enables to decompose the effects of the explanatory variables on exports into an effect on the extensive country margin, i.e. the decision to export to a country at all, and on the intensive margin, i.e. the value of exports conditional on positive exports. Additionally, and contrary to Helpman et al. (2008), their approach also takes care of potential endogenous regressors such as RTAs in the estimating equation for the extensive and intensive margin (see Challenge 5).
- (v) An easy and convenient solution to the presence of zero trade flows is to estimate the gravity model in multiplicative form instead of logarithmic form. This approach, advocated by Santos Silva and Tenreyro (2006), consists in applying the Poisson Pseudo Maximum Likelihood (PPML) estimator to estimate the gravity model.<sup>7</sup> Monte Carlo simulations show that the PPML estimator performs very well even when the proportion of zeroes is large.

### **Challenge 3: Heteroscedasticity of trade data**

It is well known that trade data are plagued by heteroscedasticity. The problem is important because, as pointed out by Santos Silva and Tenreyro (2006), in the presence of heteroscedasticity (and owing to Jensen's inequality), the estimates of the effects of trade costs and trade policy are not only biased but also inconsistent when the gravity model is estimated in log-linear form with the OLS estimator (or any other estimator that requires non-linear transformation).

**Solutions to challenge 3:** The literature proposes at least two solutions to address the issue of heteroscedasticity in the gravity equation.

- (i) Equation (1-11) can be estimated after transforming the dependent variable into size-adjusted trade, which is defined as the ratio between trade and the product of the sizes of the two markets,  $X_{j,t}/(E_{j,t}Y_{i,t})$ , (Anderson and van Wincoop, 2003). The intuition behind this adjustment is that, arguably, the variance of the error term  $\varepsilon_{j,t}$  is proportional to the product of the sizes of the two markets. A potential drawback of this approach is that it accounts for (the product of) country size as the only source of heteroscedasticity. Furthermore, using the proposed size-adjusted trade as dependent variable would not eliminate the issue of "zero trade flows" highlighted in Challenge 2.
- (ii) An alternative and more comprehensive approach, proposed by Santos Silva and Tenreyro (2006), is to apply the PPML estimator.<sup>8</sup> In addition, as discussed above, the PPML estimator also effectively handles the presence of zero trade flows, making it a very attractive choice for empirical gravity analysis.

### **Challenge 4: Bilateral trade costs**

Proper specification of bilateral trade costs is crucial for partial equilibrium as well as for general equilibrium trade policy analysis.

**Solutions to challenge 4:** The standard practice suggested in the literature is to proxy for the bilateral trade cost term appearing in the structural gravity specification (1-11),  $(1-\sigma)\ln t_{ij,t}$ , by using a series of observable variables most of which have become standard covariates in empirical gravity specifications, namely:

$$(1-\sigma)\ln t_{ij,t} = \beta_1 \ln DIST_{ij} + \beta_2 CNTG_{ij} + \beta_3 LANG_{ij} + \beta_4 CLNY_{ij} + \beta_5 RTA_{ij,t} + \beta_6 \tilde{\tau}_{ij,t} \quad (1-12)$$

The first two variables in equation (1-12) are the most widely used and robust gravity proxies for trade costs.  $\ln DIST_{ij}$  is the logarithm of bilateral distance between trading partners  $i$  and  $j$ , and  $CNTG_{ij}$  is an indicator variable that captures the presence of contiguous borders between countries  $i$  and  $j$ .<sup>9</sup>  $LANG_{ij}$  and  $CLNY_{ij}$  are dummy variables that take the value of one for common official language and for the presence of colonial ties, respectively. Finally,  $RTA_{ij,t}$  and  $\tilde{\tau}_{ij,t}$  are both trade policy variables.  $RTA_{ij,t}$  is a dummy variable that accounts for the presence of a RTA between trading partners  $i$  and  $j$  at time  $t$  by taking the value of one, and zero otherwise. The term  $\tilde{\tau}_{ij,t}$  accounts for bilateral tariffs and is defined as  $\tilde{\tau}_{ij,t} = \ln(1 + tariff_{ij,t})$ , where  $tariff_{ij,t}$  is the tariff that country  $j$  imposes on imports from country  $i$  at time  $t$ . Importantly, since tariffs act as direct price shifters, the coefficient on  $\tilde{\tau}_{ij,t}$  can be expressed only in terms of the trade elasticity of substitution  $\beta_6 = -\sigma$ , which means that the trade elasticity itself can be recovered directly from the estimate on  $\tilde{\tau}_{ij,t}$  as  $\hat{\sigma} = -\hat{\beta}_6$ . Appendix A.2 provides the derivation and implications of the structural gravity model with tariffs.

### **Challenge 5: Endogeneity of trade policy**

One of the biggest challenges in obtaining reliable estimates of the effects of trade policy within the gravity model is that the trade policy variables  $RTA_{ij,t}$  and  $\tilde{\tau}_{ij,t}$  are endogenous, because it is possible that trade policy may be correlated with unobservable cross-sectional trade costs. For instance, trade policy variables may suffer from “reverse causality”, because, all else equal, a given country is more likely to liberalize its trade with another country that is already a significant trade partner.

**Solutions to challenge 5:** The issue of endogeneity of trade policy is well-known in the trade literature (Trefler, 1993). However, primarily due to the lack of reliable instruments, early attempts to account for endogeneity with standard instrumental variable (IV) treatments in cross-sectional settings have not been successful in addressing the problem.<sup>10</sup>

Baier and Bergstrand (2007) summarize the findings from existing IV studies as “at best mixed evidence” of isolating the effect of RTAs on trade flows. The same authors propose applying the average treatment effect (ATE) methods described in Wooldridge (2010) in order to address the endogeneity of RTAs in panel trade data. In particular, *first-differencing* bilateral trade flows or using *country-pair* fixed effects eliminates or accounts for, respectively, the unobservable linkages between the endogenous trade policy covariate and the error term in gravity regressions. It should be noted that the set of pair fixed effects will absorb all bilateral time-invariant covariates (e.g. bilateral distance) that are used standardly in gravity regressions. However, the pair fixed effects will not prevent the estimation of the effects of bilateral trade policy, since trade policies are time-varying by definition. In addition the pair fixed effects will also account for any unobservable time invariant trade cost components. Egger and Nigai (2015) and Agnosteva et al. (2014) show that the pair-fixed effects are a better measure of bilateral trade costs than the standard set of gravity variables.



### **Challenge 6: Non-discriminatory trade policy**

Despite the importance of unilateral and non-discriminatory trade policies, such as export subsidies or most-favoured-nation (MFN) tariffs, and the natural interest to gauge their effects on bilateral trade flows, researchers and policy makers have struggled to estimate the effects of non-discriminatory trade policy within the structural gravity model. The issue with non-discriminatory trade policy covariates is that they are exporter- and/or importer-specific, and therefore they will be absorbed, respectively, by the *exporter-time* and by the *importer-time* fixed effects that need to be used in order to control for the multilateral resistances in the structural gravity model. More generally, in the presence of importer and exporter fixed effects, the gravity model can no longer estimate the impact of any variable (i) affecting exporters' propensity to export to all destinations (e.g. being an island); (ii) affecting imports without regard to origin (e.g. country-level average applied tariff); and (iii) representing sums, averages, and differences of country-specific variables (Head and Mayer, 2014).

**Solutions to challenge 6:** *Several approaches have been proposed in the literature to be able to estimate the impact of non-discriminatory trade policy in a gravity setting.*

- (i) One possible solution is to approximate the multilateral resistances with the “remoteness indexes” rather than including directional (exporter and importer) fixed effects. Renouncing exporter and importer fixed effects enables to identify separately the effects of country-specific policies of interest. However, this approach is not recommended because it does not account properly for the multilateral resistance terms, and is therefore likely to produce biased gravity estimates (including the effects of trade policy), as forcefully argued by Anderson and van Wincoop (2003).
- (ii) Another solution is to employ a two-stage estimation, where the estimates of the multilateral resistances from the first-stage gravity regression are explained in an auxiliary regression that includes the non-discriminatory covariate of interest (Anderson and Yotov, 2016; Head and Mayer, 2014).
- (iii) An alternative approach, proposed by Heid et al. (2015), consists in estimating the structural gravity model with *international* and *intra-national* trade flows by capitalizing on the fact that while non-discriminatory trade policies are country-specific, they do not apply to *intra-national* trade. As a result, the inclusion of *intra-national* trade implies that non-discriminatory variables become bilateral in nature, making their identification and estimation possible. As noted by Heid et al. (2015), the estimates of non-discriminatory trade policies in the structural gravity model are less likely to be subject to endogeneity concerns as compared to their bilateral counterparts for two reasons. First, it is unlikely that a non-discriminatory trade policy will be influenced by any bilateral trade flow. Second, the directional fixed effects in the structural gravity model will absorb much of the unobserved correlation between the non-discriminatory trade policy covariates and the gravity error term.

### **Challenge 7: Adjustment to trade policy changes**

It is natural to expect that the adjustment of trade flows in response to trade policy changes will not be instantaneous. For that reason, Trefler (2004) criticizes trade estimations pooled over consecutive years. The challenge of adjustment is even more pronounced in econometric specifications with fixed effects such as the ones described in this section. As noted in Cheng and Wall (2005),

fixed-effects estimation applied to data pooled over consecutive years is sometimes criticized on the grounds that dependent and independent variables cannot fully adjust in a single year's time.

**Solutions to challenge 7:** In order to avoid this critique, researchers have used panel data with intervals instead of data pooled over consecutive years. For example, Treffer (2004) uses 3-year intervals, Anderson and Yotov (2016) use 4-year intervals, and Baier and Bergstrand (2007) use 5-year intervals. Olivero and Yotov (2012) provide empirical evidence that gravity estimates obtained with 3-year and 5-year interval trade data are very similar, while estimations performed with panel samples pooled over consecutive years produce suspicious estimates of the trade cost elasticity parameters.

### Challenge 8: Gravity with disaggregated data

Many trade policies are negotiated and applied at the sectoral level, such as tariffs. While it is in principle possible to aggregate trade policy and still use the aggregate gravity model, such aggregation practices should be avoided and, whenever possible, gravity should be estimated at the level of aggregation which is the target of the specific policy. Furthermore, even for policies that are negotiated at the aggregate level (e.g. some RTAs), it may be desirable to also obtain sectoral effects because the effects of these non-discriminatory policies may actually be quite heterogeneous across sectors.

**Solutions to challenge 8:** Fortunately, one of the most attractive properties of the structural gravity theory is that the model is separable. In other words, bilateral expenditures across countries both at the aggregate and at the sectoral level are separable from output and expenditure at the country level (Larch and Yotov, 2016b). As demonstrated by Anderson and van Wincoop (2004), one nice implication of separability is that for a given set of country-level output ( $Y_{i,t}^k$ ) and expenditure ( $E_{j,t}^k$ ) values, where  $k$  denotes a class of goods/sector, theory delivers the familiar sectoral gravity equation:

$$X_{ji,t}^k = \frac{Y_{i,t}^k E_{j,t}^k}{Y_i^k} \left( \frac{t_{ji,t}^k}{P_{j,t}^k \Pi_{i,t}^k} \right)^{1-\sigma_k} \quad (1-13)$$

Two properties of equation (1-13) deserve a note. First, by definition, the bilateral trade costs  $t_{ji,t}^k$ , including the effects of trade policy, are sector-specific. Second, the multilateral resistances are sector-specific as well. From an empirical perspective, trade separability implies that equation (1-13) can be estimated for each sector as if the data were aggregate. Alternatively, the gravity model can be estimated with data pooled across sectors, in which case the proper treatment of the multilateral resistance requires *exporter-product-time* and *importer-product-time* fixed effects, and the effects of trade policy should be allowed to vary by sector. Depending on the question of interest, the estimates of the trade policy variables in gravity estimations that are pooled across sectors can be sector-specific or constrained to be common across sectors.

### (b) Practical recommendations for estimating structural gravity model

Taking into account all of the above considerations and combining the best solutions suggested in the literature to address the challenges with the estimation of the gravity model, the following best practices for estimating structural gravity equations are highly recommended:

**Recommendation 1:** *Whenever available, panel data should be used to obtain structural gravity estimates.*

Various reasons motivate this recommendation. First, using panel data leads to improved estimation efficiency. Second, the panel dimension enables to apply the pair-fixed-effects methods to address the issue of endogeneity of trade policy variables (Baier and Bergstrand, 2007). Third, on a related note, the use of panel data allows for a flexible and comprehensive treatment and estimation of the effects of time-invariant bilateral trade costs with pair fixed effects. The downside is that, as discussed in Box 2, panel data may not always be available.

**Recommendation 2:** *Panel data with intervals should be used instead of data pooled over consecutive years in order to allow for adjustment in trade flows.*

Interval panel data should be employed in order to allow for adjustment in bilateral trade flows in response to trade policy or other changes in trade costs. Olivero and Yotov (2012) build a dynamic gravity model and experiment with alternative interval specifications and find that gravity estimates obtained with 3-, 4-, and 5-year lags deliver similar results with respect to the estimates of the standard gravity variables. It is recommended to experiment with alternative intervals while keeping estimation efficiency in mind.

**Recommendation 3:** *Gravity estimations should be performed with intra-national and international trade flows data.*

The inclusion of *intra-national* trade data in structural gravity estimations is desirable for several reasons. First, it ensures consistency with gravity theory, where consumers choose among and consume domestic as well as foreign varieties. Second, it leads to the theoretically consistent identification of the effects of bilateral trade policies (Dai et al., 2014). Third, it also enables to identify and estimate the effects of non-discriminatory trade policies (Heid et al., 2015). Fourth, it resolves the “distance puzzle” in trade, by measuring the effects of distance on international trade relative to the effects of distance on internal trade (Yotov, 2012). Finally, it enables to capture the effects of globalization on international trade and to correct for biases in the estimation of the impact of RTAs on trade (Bergstrand et al., 2015). Importantly, *intra-national* trade data has to be constructed consistently as the difference between *gross* production value data and total exports. Section 4 provides further discussion on the construction and sources of *intra-national* trade data.

**Recommendation 4:** *In accordance with gravity theory, directional time-varying (importer and exporter) fixed effects should be included in panel trade data.*

The use of *exporter-time* and *importer-time* fixed effects enables to control for the unobservable multilateral resistances, and potentially for any other observable and unobservable *characteristics* that vary over time for each exporter and importer, respectively (Anderson and van Wincoop, 2003). In addition, as will be discussed in detail in Chapter 2, the estimates of the fixed effects of the gravity model can be used directly to recover the estimates of the general equilibrium effects of trade policy changes as well as to construct a series of useful general equilibrium indexes

summarizing and aggregating consistently the effects of trade policy and trade costs (Anderson et al., 2015b; Larch and Yotov, 2016b).

```
* STATA commands to create importer- and exporter-time fixed effects:
egen exp_time = group(exports year)
    tabulate exp_time, generate(EXPORTER_TIME_FE)
egen imp_time = group(imports year)
    tabulate imp_time, generate(IMPORTER_TIME_FE)
```

**Recommendation 5:** *Pair fixed effects should be included in gravity estimation with panel trade data.*

Two major benefits are associated with using pair fixed effects in gravity estimations. First, the pair fixed effects are able to account for the endogeneity of trade policy variables (Baier and Bergstrand, 2007). Second, on a related note, the pair fixed effects provide a flexible and comprehensive account of the effects of all time-invariant bilateral trade costs, because pair fixed effects have been shown to carry systematic information about *trade* costs in addition to the information captured by the standard gravity variables (Egger and Nigai, 2015; Agnosteva et al., 2014). The downside of using pair fixed effects is that one cannot identify the effects of any time-invariant bilateral determinants of trade flows, because the latter will be absorbed by the pair fixed effects. One way to address this issue is to apply a two-stage procedure, where the estimates of the pair fixed effects from the first-stage structural gravity equation are regressed on standard gravity variables in a second-stage estimation (Agnosteva et al., 2014). This two-step approach also enables to recover estimates of the pair fixed effects that cannot be identified directly in the first stage, due to missing or zero trade flows, and then the complete set of pair fixed effects can be used to construct the full matrix of bilateral trade costs and to perform counterfactual experiments (Anderson and Yotov, 2016).

```
* STATA commands to compute country-pair fixed effects:
* Asymmetric country-pair fixed effects
egen pair_id = group(exports importer)
    tabulate pair_id, generate(PAIR_FE)

* Symmetric country-pair fixed effects
* Short-cut code valid if none of the pairs has identical distances.
egen pair_id = group(DIST)
    tabulate pair_id, generate(PAIR_FE)
```

**Recommendation 6:** *Estimate gravity with the Poisson Pseudo Maximum Likelihood (PPML) estimator.*

The use of the PPML estimator is justified on various grounds. First, the PPML estimator, applied to the gravity model expressed in a multiplicative form, accounts for heteroscedasticity, which often plagues trade data (Santos Silva and Tenreyro, 2006). Second, for the same reason, the PPML estimator is able to take advantage of the information contained in the zero trade flows. Third, the

additive property of the PPML estimator ensures that the gravity fixed effects are identical to their corresponding structural terms (Arvis and Shepherd, 2013; Fally, 2015). Finally, as will be reviewed in greater details in Chapter 2, the PPML estimator can also be used to *calculate* theory-consistent general equilibrium effects of trade policies (Anderson et al., 2015b; Larch and Yotov, 2016b). As a robustness check, the gravity model can be estimated by applying the Gamma Pseudo Maximum Likelihood (GPML) and the OLS estimators (Head and Mayer, 2014).<sup>11</sup>

```
* STATA commands to estimate gravity model with the PPML estimator:
ppml trade EXPORTER_TIME_FE* IMPORTER_TIME_FE* PAIR_FE* RTA, cluster(pair_id)

* Alternative command: glm
glm trade EXPORTER_TIME_FE* IMPORTER_TIME_FE* PAIR_FE* RTA, cluster(pair_id) ///
family(poisson) diff iter(30)
```

### Box 2 In the absence of panel trade data

When panel data are not available, the gravity model can still be estimated with cross-section samples:

$$\ln X_{ij} = \ln E_j + \ln Y_i - \ln Y + (1 - \sigma) \ln t_{ij} - (1 - \sigma) \ln P_j - (1 - \sigma) \ln \Pi_i + \varepsilon_{ij}$$

In a cross-section setting, recommendations 3, 4, and 6 mentioned above continue to hold, namely gravity specification should include *intra-national* trade and directional (importer and exporter) fixed effects, and be estimated applying the PPML estimator.

However, the recommendations 2 and 5 to allow for adjustment in trade flows by using interval data and to include pair fixed effects are no longer applicable. The gravity specification in cross-section should include the standard set of gravity variables (e.g., bilateral distance, contiguity ...) instead of pair fixed effects, in order to proxy for bilateral trade costs. That being said, as pointed out by Egger and Nigai (2015) and Agnosteva et al. (2014), the error term should be interpreted with caution, because it may capture systematic effects of unobserved trade costs. In order to address the endogeneity of bilateral trade policy, IV treatment is highly recommended (Baier and Bergstrand, 2004; Egger et al., 2011).

### (c) A theoretically-consistent estimating structural gravity model

The best practices and recommendations proposed in the previous section are reflected in the following generic and comprehensive econometric version of the structural gravity model, which can be modified and adjusted by researchers and policy makers depending on their specific needs:

$$X_{ij,t} = \exp \left[ \pi_{i,t} + \chi_{j,t} + \mu_{ij} + \eta_1 BTP_{ij,t} + \eta_2 NES_{i,t} \times INTL_{ij} + \eta_3 NIP_{j,t} \times INTL_{ij} \right] \times \varepsilon_{ij,t} \quad (1-14)$$

The variable  $X_{ij,t}$  denotes nominal trade flows, which include *international* and *intra-national* trade, at non-consecutive year  $t$ . The term  $\pi_{i,t}$  denotes the set of time-varying source-country dummies, which control for the outward multilateral resistances, countries' output shares and, potentially any other observable and unobservable exporter-specific factors that may influence bilateral trade. The term  $\chi_{j,t}$  encompasses the set of time-varying destination-country dummy variables that account for the inward multilateral resistances, total expenditure, and any other observable and unobservable importer-specific characteristics that may influence trade. The term  $\mu_{ij}$  denotes the set of country-pair fixed effects, which serve two main purposes as highlighted in the previous section. First, the pair fixed effects are the most flexible and comprehensive measure of time-invariant bilateral trade costs because they will absorb all time-invariant gravity covariates from equation (1-12) along with any other time-invariant bilateral determinants of trade costs that are not observable by the researcher and/or the policy maker. Second, the pair fixed effects will absorb most of the linkages between the endogenous trade policy variables and the remainder error term  $\varepsilon_{ij,t}$  in order to control for potential endogeneity of the former. In principle, it is possible that the error term in gravity equations may carry some systematic information about trade costs. However, due to the rich fixed effects structure in equation (1-14), researchers should be more confident to treat and interpret  $\varepsilon_{ij,t}$  as a true measurement error. Finally, whether the error term  $\varepsilon_{ij,t}$  in equation (1-14) is introduced as additive or multiplicative does not matter for the PPML estimator (Santos Silva and Tenreiro, 2006).

The term  $BTP_{ij,t}$  represents the vector of any time-varying bilateral determinants of trade flows, such as RTAs, bilateral tariffs and currency unions. In principle, the  $BTP_{ij,t}$  vector may include any time-varying covariates, however, given the focus on trade policy of this *Advanced Guide*, the expression  $BTP$  stands for Bilateral Trade Policy. The expression  $NES_{i,t} \times INTL_{ij}$  corresponds to the product between  $NES_{i,t}$  and  $INTL_{ij}$ . The term  $NES_{i,t}$  denotes the vector of any Non-discriminatory Export Support (NES) policies, such as export subsidies, while  $INTL_{ij}$  is a dummy variable taking a value of one for international trade between countries  $i$  and  $j$ , and zero otherwise. Importantly, the interaction between the country-specific NES variables and the bilateral dummy for international trade flows results in a new bilateral term, i.e.  $NES_{i,t} \times INTL_{ij}$ , which will enable to identify the effects of any non-discriminatory export support policies, even in the presence of exporter-time fixed effects as required by gravity theory (Heid et al., 2015). In addition, with appropriate data on export support measures that act as direct price-shifters, the estimate of the coefficient(s) associated with the variable(s)  $NES_{i,t} \times INTL_{ij}$  can be used to recover an estimate of the export supply elasticity, which plays a prominent role in theoretical trade policy analysis but has attracted little attention in the empirical trade literature. Similarly, the covariate  $NIP_{j,t} \times INTL_{ij}$  is constructed as the product between the term  $NIP_{j,t}$ , which denotes the vector of any Non-discriminatory Import Protection (NIP) policies, such as MFN tariffs, and the dummy for bilateral international trade  $INTL_{ij}$ . Given its bilateral nature, the expression  $NIP_{j,t} \times INTL_{ij}$  can be used to identify the effects of any non-discriminatory import protection policies.

```
* STATA commands to compute the term  $NES_{i,t} \times INTL_{ij}$  and  $NIP_{j,t} \times INTL_{ij}$ :
generate INTL = 1
    replace INTL = 0 if exporter == importer
generate NES_INTL = NES * INTL
generate NIP_INTL = NIP * INTL
```

### 3. Gravity estimates: interpretation and aggregation

Once equation (1-14) has been estimated, the researcher may be interested in interpreting and/or aggregating some of the estimates of the gravity model. This section discusses various approaches to interpret the gravity estimates in terms of partial equilibrium effects on bilateral trade, including the tariff equivalents of non-tariff trade policy variables. In addition, theoretically-consistent methods to aggregate bilateral trade costs into a single figure are presented too.

#### (a) Interpretation of gravity estimates

Two related methods are widely used to interpret the estimates from gravity regressions. The first approach is to use the gravity estimates to construct *trade volume effects*, while the second approach capitalizes on the theoretical foundations of gravity to convert the estimates of various trade policies and other determinants of trade flows into *tariff equivalent effects*. In order to demonstrate how the structural gravity estimates can be translated into trade volume effects and interpreted as tariff equivalent effects, the following simplified version of the empirical gravity model (1-14) is considered:

$$X_{j,t} = \exp \left[ \pi_{i,t} + \chi_{j,t} + \beta_{DIST} \ln DIST_{ij} + \beta_{RTA} RTA_{j,t} + \beta_{TARIFF} \tilde{\tau}_{j,t} \right] \times \varepsilon_{j,t} \quad (1-15)$$

The variable  $\ln DIST_{ij}$  denotes the logarithm of bilateral distance between countries  $i$  and  $j$ . The covariate  $RTA_{j,t}$  represents an indicator variable taking the value of one if there is a RTA between countries  $i$  and  $j$  at time  $t$ , and zero otherwise. For expositional purposes, both variables  $\ln DIST_{ij}$  and  $RTA_{j,t}$  will be used, respectively, as representative continuous variable and dummy variable in gravity regressions. Finally,  $\tilde{\tau}_{j,t} = \ln(1 + tariff_{j,t})$  accounts for bilateral tariffs, where  $tariff_{j,t}$  is the ad-valorem tariff that country  $j$  imposes on imports from country  $i$  at time  $t$ . Importantly, as emphasized earlier, the coefficient on bilateral tariffs,  $\beta_{TARIFF}$ , can be interpreted in the context of the structural gravity model as the trade elasticity of substitution, namely  $\beta_{TARIFF} = -\sigma$ . Overall, the interpretation of the coefficient on tariffs in gravity regressions depends on the trade flow data used to estimate the model, which here are assumed to be expressed at *cost, insurance and freight (c.i.f) prices*, but not tariffs. See Appendix B of this chapter for further details.

#### **Trade volume effects**

The construction of trade volume effects from gravity estimates is straightforward but depends on the nature of the variable, namely whether it is a continuous or an indicator variable.

**Trade volume effect of continuous variables.** In the case of continuous variables, such as bilateral distance, the interpretation of the estimate of the coefficient on the logarithm of the continuous variable is simply the elasticity of (the value of trade flows) with respect to the continuous variable. For example, the standard empirical value for the distance variable estimate in gravity regressions of  $\hat{\beta}_{DIST} = -1$  implies that a 10 percent increase in distance should be accompanied by a 10 percent decrease in trade flows (Disdier and Head, 2008; Head and Mayer, 2014).

**Trade volume effect of indicator variables.** The volume effects triggered by a change in an indicator gravity variable, such as the presence of RTAs, can be calculated in percentage terms as follows:

$$\left[ e^{\hat{\beta}_{dummy}} - 1 \right] \times 100 \quad (1-16)$$

where  $\hat{\beta}_{dummy}$  is the estimate of the effects of any indicator gravity variable specified in the gravity model. For example, the benchmark estimate of the effects of RTAs in gravity regressions found in the empirical literature of  $\hat{\beta}_{RTA} = 0.76$  implies that the RTAs that entered into force between 1960 and 2000 on average have increased trade by  $[e^{0.76} - 1] \times 100 = 114$  percent (Baier and Bergstrand, 2007).

With the exception of the direct price shifters, such as tariffs, the estimates of the remaining gravity covariates consist of two components: (i) a structural component and (ii) a trade cost component. For example, the structural interpretation of the estimate of the coefficient of distance is  $\hat{\beta}_{DIST} = (1 - \hat{\sigma})\rho$ , where  $\rho$  is the elasticity of trade costs with respect to distance. This decomposition is useful for two reasons. First, because it enables to recover the direct effects of distance, namely  $\rho = \hat{\beta}_{DIST} / (1 - \hat{\sigma})$ . Empirical evidence based on this approach suggests that the distance variable in gravity estimations accounts for much more than just transportation costs (Head and Mayer, 2013). Second, because it can, as discussed next, be used to convert gravity estimates into tariff equivalent effects.

```
* STATA commands to compute trade volume effects:
ppml trade IMPORTER_FE* EXPORTER_FE* LN_DIST CNTG RTA TARIFF
scalar TradeVolumeEffectCNTG = (exp(_b[CNTG]) - 1) * 100
scalar TradeVolumeEffectDIST = _b[LN_DIST] * 100
```

### Tariff equivalent effects

Quantifying the effects of tariffs is useful both from a policy and from a pedagogical perspective. However, the proliferation of non-tariff trade measures poses big challenges in quantifying their effects on international trade. Furthermore, it is often useful and desirable to be able to express the effects of alternative trade policies in a consistent measure. The structural gravity model offers a solution that enables researchers and policy makers to translate the effects of concluding any trade policy variable into a tariff equivalent effect, i.e. to find the ad-valorem tariff whose removal would have generated the same impact as the trade policy in question. In the context of equation (1-16), the tariff equivalent effect of RTAs would be equal to:<sup>12</sup>

$$\left[ e^{\hat{\beta}_{RTA} / \hat{\beta}_{TARIFF}} - 1 \right] \times 100 \quad (1-17)$$

where  $\hat{\beta}_{RTA}$  and  $\hat{\beta}_{TARIFF}$  are the estimates of the coefficient associated with variables RTAs and tariffs specified in equation (1-15), respectively.



In an ideal situation, the effects of tariffs and all other determinants of trade could and should be obtained within the same theoretically-consistent empirical specification. Although, as discussed earlier, most gravity estimations do not include tariffs, this does not necessarily preclude the calculation of tariff equivalent effects by relying on the structural properties of the gravity model in order to construct them. In particular, capitalizing on the structural interpretation of the coefficient on tariffs as  $\beta_{TARIFF} = -\sigma$ , where  $\sigma$  is the trade elasticity of substitution, equation (1-17) becomes:

$$\left[ e^{\hat{\beta}_{RTA}/(-\hat{\sigma})} - 1 \right] \times 100 \quad (1-18)$$

An advantage of the structural specification (1-18) is that it demonstrates that, in principle, no data on tariffs are needed in order to obtain tariff equivalent effects of other gravity covariates as long as reliable estimates of the trade elasticity of substitution are available from outside studies. Returning to the example of the effects of RTAs from Baier and Bergstrand (2007), and taking a representative value for the elasticity of substitution from the literature<sup>13</sup>,  $\sigma = 5$ , the average tariff-equivalent fall of the introduction of RTAs would amount to  $[e^{0.76/(-5)} - 1] \times 100 = 17.3$  percent.

```
* STATA commands to compute tariff equivalent effects:
ppml trade IMPORTER_FE* EXPORTER_FE* LN_DIST RTA TARIFF

* If trade elasticity of substitution is taken from tariff estimates
scalar TariffEquivalentRTA_1 = (exp(_b[RTA]/(-_b[TARIFF]) - 1) * 100

* If trade elasticity of substitution is taken from literature
scalar sigma = 5
scalar TariffEquivalentRTA_1 = (exp(_b[RTA]/(-sigma)) - 1) * 100
```

## (b) Consistent aggregation of bilateral trade costs

Aggregation of bilateral trade costs may be desirable for many policy purposes. For example, policy makers in a customs union or common market may wish to aggregate the effects of changes in bilateral trade costs of members to the level of the customs union or common market. Similarly decision makers may wish to aggregate interprovincial trade costs to the national level. Finally, national agencies may find it useful to consistently aggregate sectoral trade costs to the aggregate level of the economy. While a-theoretic weights are often used to form such indexes, the literature emphasizes the practical importance of theoretically consistent weights (Anderson and Neary, 2005). Different theoretically consistent aggregation methods have been proposed in the literature (Agnosteva et al., 2014). Although, for expositional purposes, the focus will be on the aggregation across regions within a customs union at a given point of time, similar principles apply for consistent aggregation over sectors.

The goal is to consistently aggregate bilateral trade costs  $t_{ij}$  within a customs union (CU) so as to preserve the aggregate export volume from  $i$  to destinations  $j$  in the subset of countries that belong to the CU,  $j \in CU(i)$ ,  $j \neq i$ . Following Agnosteva et al. (2014), the effect of changes

in bilateral trade costs  $t_{ij}$ ,  $j \in CU(i)$  on the multilateral resistances  $\Pi_i$  and  $P_j$  are ignored. This assumption is particularly useful for practical purposes and it is justified for subsets with small trade volume shares. Alternatively, a more computationally intensive procedure should take into account the changes in the multilateral resistances that are driven by changes in bilateral trade costs.

Under the assumption of no change in bilateral trade costs, the volume equivalent uniform bilateral trade cost index  $b_{CU(i)}$  is implicitly defined as:

$$\sum_{j \in CU(i)} X_{ij} = \sum_{j \in CU(i)} \frac{Y_i E_j}{Y} \left( \frac{t_{ij}}{\Pi_i P_j} \right)^{1-\sigma} = \sum_{j \in CU(i)} \frac{Y_i E_j}{Y} \left( \frac{b_{CU(i)}}{\Pi_i P_j} \right)^{1-\sigma} \quad (1-19)$$

Dividing the middle and rightmost expressions of equation (1-19) by  $Y_i / (\Pi_i^{1-\sigma} Y)$  and solving for  $b_{CU(i)}$  yields:

$$b_{CU(i)} = \left[ \frac{\sum_{j \in CU(i)} \frac{\frac{E_j}{P_j^{1-\sigma}}}{\sum_{k \in CU(i)} \frac{E_k}{P_k^{1-\sigma}}} t_{ij}^{1-\sigma}}{\sum_{k \in CU(i)} \frac{E_k}{P_k^{1-\sigma}}} \right]^{\frac{1}{1-\sigma}} \quad (1-20)$$

Equation (1-20) reveals that the CU regional trade cost aggregate is a weighted-average across the bilateral trade costs for the exporters in the CU region. The weights in equation (1-20) can be interpreted in the spirit of the market access and market potential indexes from the economic geography literature (Redding and Venables, 2004). From a practical perspective, the weights can be constructed directly from the importer fixed effects,  $\chi_j$ , in the estimating gravity equation (1-14), so that the aggregating equation becomes:

$$b_{CU(i)} = \left[ \frac{\sum_{j \in CU(i)} \frac{\chi_j}{\sum_{k \in CU(i)} \chi_k} t_{ij}^{1-\sigma}}{\sum_{k \in CU(i)} \chi_k} \right]^{\frac{1}{1-\sigma}} \quad (1-21)$$

Applying the same principles and methods delivers a consistent aggregate of bilateral trade costs for the customs union on the demand side:

$$b_{CU(j)} = \left[ \frac{\sum_{i \in CU(j)} \frac{\frac{Y_i}{\Pi_i^{1-\sigma}}}{\sum_{k \in CU(j)} \frac{Y_k}{\Pi_k^{1-\sigma}}} t_{ij}^{1-\sigma}}{\sum_{k \in CU(j)} \frac{Y_k}{\Pi_k^{1-\sigma}}} \right]^{\frac{1}{1-\sigma}} = \left[ \frac{\sum_{i \in CU(j)} \frac{\pi_i}{\sum_{k \in CU(j)} \pi_k} t_{ij}^{1-\sigma}}{\sum_{k \in CU(j)} \pi_k} \right]^{\frac{1}{1-\sigma}} \quad (1-22)$$

where, as can be seen from the rightmost expression, the aggregating weights are now the exporter fixed effects,  $\pi_i$ , from the gravity equation (1-14).

Expressing equations (1-21) and (1-22) in terms of importer and exporter fixed effects, respectively, is important for two reasons. First, from a theoretical perspective, owing to the additive property of the PPML estimator, the estimates of the gravity fixed effects correspond exactly to the structural gravity terms (Arvis and Shepherd, 2013; Fally, 2015). Second, from a practical perspective, this implies that consistent aggregation of bilateral trade costs at any level can be obtained in three simple steps:

*Step 1: Estimate the gravity model with the PPML estimator.*

*Step 2: Construct bilateral trade costs  $t_{j,t}$  for each pair.*

*Step 3: Aggregate bilateral trade costs at the desired level with the estimates of:*

- *importer fixed effects used as weights for the supply-side analysis ( $CU_{(i)}$ ).*
- *exporter fixed effects used as weights for the demand-side analysis ( $CU_{(j)}$ ).*

#### 4. Gravity data: sources and limitations

Gravity equations have been estimated using a variety of country-specific and bilateral variables as determinants of bilateral trade flows. The goal of this section is to review the main data sources and the data limitations that researchers have faced when using these sources. Following the recommendation that gravity should be estimated with *exporter(-time)* and *importer(-time)* fixed effects, and also for brevity purposes, this section will mainly focus on data for the dependent gravity variable, i.e. bilateral trade flows, and on data that can be used to construct proxies for bilateral trade distortions. All web links for the data sources discussed in this section are provided as active links in Appendix C.

##### (a) Bilateral trade flows data

Traditionally, gravity estimations have mostly been performed with aggregate data. However, mainly due to availability of more and more reliable disaggregated data, an increasing number of studies present sectoral and even product gravity analysis.

##### **Aggregate trade flows data**

The primary source of information for aggregated (country-level) bilateral trade flows is the International Monetary Fund (IMF)'s Direction of Trade Statistics (DOTS). The database covers 184 countries. Annual data are available from 1947, while monthly and quarterly data start from 1960. Data are reported in US dollars. Relying on DOTS and other national sources of data, Barbieri and Keshk have created a database (Correlates of War Project) that tracks total national trade and bilateral trade flows (imports and exports) between states from 1870-2009 in current US dollars.

### **Merchandise trade flows data**

Availability of trade flows data at the disaggregated level depends on the sector in question. Data on merchandise trade flows are available at disaggregated level and for a long period of time for several data sources. The UN Commodity Trade Statistics Database (COMTRADE) is the most common source of data of disaggregated trade by commodity. It reports annual bilateral trade flow data expressed in gross value and volume from 1962 for more than 160 countries on average. Monthly data are also available since 2010. Trade values are in current US dollars converted from national currencies. Data are available online through the UN website or through the World Bank's World Integrated Trade Solution (WITS) portal. The data are accessible in different nomenclatures and in different levels of disaggregation. Trade data classified according to the Harmonised System (HS) are available up to the 6-digit level (that is, at a level of detail that distinguishes about 5,000 separate goods items), which is the most disaggregated classification that is consistent across countries at the international level. Annual trade data are also classified using the Standard International Trade Classification (SITC). This classification focuses more on the economic functions of products at various stages of processing rather than the physical characteristics of a product. In its Rev. 4 version this classification reaches 5 digit (2,970 lines). Concordance tables exist to match data in HS and SITC classifications.

Measurement error is a standard problem with trade data. Import data have been traditionally more reliable because imports are monitored much more closely than exports by customs administrations, since the former are often subject to an import duty. Therefore, it is often advisable to use import data to construct the main dependent variable in gravity regressions. It is also recommended to use "mirror data", that is to use imports data from destination countries as a measure of exports from origin countries. It should be noted, however, that mirroring may not be a good idea in cases when the importing country applies very high tariffs and has weak monitoring capability at customs. In these cases, the incentive to avoid tariffs and border controls may lead to largely underestimated import data. For this reason, it is not uncommon to have declared imports of country  $j$  from exporter  $i$  that are lower than the declared exports of  $i$  to destination  $j$ , even though imports are reported at *cost, insurance and freight (c.i.f) prices* and exports are reported at *free on board (f.o.b) prices*, which do not include any costs associated with transportation.

In an attempt to reconcile declarations of importers and exporters in COMTRADE, the Centre d'Etudes Prospectives et d'Informations Internationales (CEPII) has created the Base Analytique du Commerce International (BACI). In addition, the BACI data are also cleaned to exclude re-exports. The BACI database provides trade data at the 6-digit HS level for more than 200 countries from 1995. Because the construction and processing of the BACI database requires time and it is based on original data from other primary sources, such as COMTRADE, the BACI data are available to the public with a time lag of one or two years as compared to COMTRADE. Finally, to tackle the problem of measurement errors, the World Trade Flows (WTF) database developed by Feenstra and Romalis (2014) omits observation where the ratio between *c.i.f* and *f.o.b* is either less than 0.1 or larger than 10 and where the *c.i.f* value is smaller than 50,000 US dollars. The WTF database contains bilateral trade data for 185 countries covering, on average, the period 1984-2014.

### **Services trade flows data**

Although there has been a significant effort and advances to offer data on trade in services, the availability of data on bilateral trade flows in services remains relatively limited. The Organisation for Economic Co-operation and Development (OECD) Trade in Services database offers data on bilateral services trade for 12 main services sectors and several sub-sectors according to the Extended Balance of Payments (EBOPS) 2010 classification (146 categories in total). The OECD database covers 35 countries including 32 OECD member countries as well as the Russian Federation, Colombia and Latvia from 1999 onwards. The UN Service Trade Database covers 46 economies from 2000 onwards and follows the EBOPS 2002 classification (114 categories: 86 standard items (11 main items), 24 memorandum items and 4 supplementary items). The WTO, UNCTAD and International Trade Centre (ITC) also jointly develop a database which contains bilateral annual service flows data for 36 countries at the same level of disaggregation as the OECD data from 2005 onwards according to the EBOPS 2010 classification. These bilateral data can be retrieved from the ITC TradeMap. An older version of this database, following the previous services classification (EBOPS 2002), covers 49 countries for the period 1980-2013.<sup>14</sup> Finally, based on adjusted data from the OECD, Eurostat, UN and IMF, the Trade in Service database, developed by Francois and Pindyuk (2013), reports bilateral service flows data classified according to the EBOPS 2002 classification and covering 248 countries, on average, for the period 1981-2010. Data comes from the OECD, Eurostat, UN and IMF. Adjustments have been made using mirroring, reconciliation of aggregated with underlying flows and consolidation. Services are classified according to the EBOPS 2002 classification.

### **Agriculture and resource sectors data**

The UN Food and Agriculture Organization Corporate Statistical Database (FAOSTAT) collects information on an annual basis in more than 100 countries. The Detailed Trade Matrix reports information on agricultural bilateral trade flows for over 600 food and commodities per year. It provides data for both quantities (in tons) and values (in thousands of US dollars) of agricultural imports and exports. Data are available for the period 1986-2013 and are gathered from national sources.

### **Intra-national trade flows data**

As argued above, the use of *intra-national* trade flows data is desirable and consistent with gravity theory. However, such data are not readily available and their use requires caution. Some countries, such as Canada, have devoted significant resources and special attention to carefully construct intra-national trade flows.<sup>15</sup> However, constructing an international database of intra-national trade flows is challenging for at least two reasons. First, traditionally researchers have constructed intra-national trade flows as apparent consumption, defined as the difference between production and total exports. However, aggregate production data are usually measured and reported as *value added* (e.g. GDP), while total exports are reported as *gross value*. That is why the production databases described below are based on sectoral data, usually covering goods only, for which value added and gross values are available and reported. Typically production data are classified using the Standard Industrial Classification (SIC). This nomenclature classifies products at the 4-digit level at the highest level of detail. Although concordance tables between

various nomenclatures exist, matches are not perfect and one may need to move to higher levels of aggregation to guarantee a better match.

Despite these (and other) limitations, there have been efforts to merge bilateral trade and production data in order to construct consistent databases of international and intra-national trade flows, in particular for the manufacturing sectors. The World Bank's Trade, Production and Protection (TPP) database covers approximately 100 countries for the period 1976-2004 with information classification according to the Industrial Standard Industrial Classification (ISIC) Rev. 3 at the 3-digit level. The CEPII's Trade, Production and Bilateral Protection (TradeProd) provides data for over 150 countries for the period 1980-2006 expressed in ISIC Re. 2 at the 3-digits level. The UN Industrial Development Organization (UNIDO) Industrial Statistics (INDSTAT) reports data from 1962 onwards at the 2-digit level of ISIC Rev. 3 (INDSTAT2) or from 1990 onwards at the 4-digit level (INDSTAT4) for 166 countries.<sup>16</sup>

### (b) Bilateral trade costs data

As discussed earlier, one of the estimation challenges with gravity equations is to proxy for the unobservable bilateral trade costs  $t_{j,t}$  formulated in the structural gravity model. Traditionally, the bilateral trade costs in gravity equations are proxied by a series of observable variables that determine trade costs. From a broad practical perspective, trade costs can be divided into their time-varying and time-invariant components. Although, by nature, trade policy variables are time-varying, most of the standard gravity variables that are routinely included in gravity estimations include time-invariant (or very slowly time varying) covariates such as physical distance, contiguous borders, common language, and common history and colonial ties. The CEPII's GeoDist database reports data on time-invariant gravity variables for 225 countries (Mayer and Zignago, 2011).

### (c) Trade policy data

Trade policies are typically divided in tariffs and non-tariff measures (NTMs). Data on various trade policies are available through three main portals: the WTO's Tariff and NTM portals; the World Bank's World Integrated Trade Solution (WITS); and the ITC's various web-based "Map" tools. The main data sources on specific trade policy measures are presented below.

#### **Tariff data**

Tariffs can be classified into three groups:

- (i) MFN bound tariffs are the tariff ceiling above which countries have committed not to raise their applied tariff.<sup>17</sup>
- (ii) MFN applied tariffs are the MFN tariffs imposed by a WTO member country on imports from other WTO members.
- (iii) Preferential tariff rates are the tariffs countries have bilaterally negotiated under RTAs.

The WTO provides facilities to download tariff data for each of these three groups of tariffs. Applied tariffs data notified to the WTO can be found in the WTO's Integrated Data Base (IDB). The IDB contains data on MFN duties for applied and preferential duties for WTO member countries on an annual basis from 1996 onwards. Data are available at the tariff line level as reported by the country imposing these tariffs, i.e. more detailed than HS 6-digit level. The Consolidated Tariffs Schedules (CTS) database contains bound tariffs, tariff quotas and export subsidies bound commitments at the tariff line level, as well as domestic support commitments. Access to the IDB and CTS databases is possible through the WTO's Tariff Analysis Online (TAO) interface and for HS 6-digit pre-aggregated data through the Tariff Download Facility. The World Bank's WITS, developed in collaboration with UNCTAD, gathers together the WTO's IDB and CTS database, UNCTAD's Trade Analysis Information System (TRAINS) data along with trade flows data from the UN COMTRADE, data from Market Access Maps MacMap and the OECD's Agriculture Market Access Database in a unique interface to facilitate data extraction.

In practice, countries set tariffs at the tariff line level, which can be at the 6-, 8-, 9-, 10-, or 12-digit HS level depending on the country. Yet, researchers may need to aggregate tariffs in order to perform cross country comparisons, work with a dataset of a manageable size and/or match the information with information available for other variable, such as bilateral trade flows. Two simple approaches to aggregate tariffs have been proposed in the literature: (i) a simple average aggregation procedure, and (ii) an import-weighted average method. While simple and easy to implement, each of these procedures is subject to caveats. For example, when import-weighted averages are used to estimate the average degree of protection in a certain country, tariff lines with very high tariffs will have a low weight, because imports subject to high protection rates are likely to be small. At the extreme, paradoxically, for a given level of total imports, the contribution to the import-weighted average tariff of goods subject to prohibitive tariffs is the same as the contribution of goods subject to zero tariffs. In fact, in both cases the product between the tariff and the level of import will be zero. Similarly, using the simple average method may also be misleading, because the tariff rate associated with a good that represents an important share of the total trade of a sector has the same impact on the calculated average tariff as that of a good that represents a minimal share of trade. In order to tackle these tariff aggregation problems, the ITC MacMap database includes weighted tariffs at the HS 6 digit level that are calculated on the basis of a reference group weighting scheme. Five groups of reference countries have been identified according to the PPP GDP per capita and trade openness. Total imports by a given group are normalized to account for its size. Then, the measure obtained is used as weight to aggregate data across partners and products (Bouët et al., 2005). MacMap includes MFN and preferential tariff data for the years 2005-2014 up to the national tariff line level for 190 countries.

### ***Main non-tariff measures (NTMs) databases***

Non-tariff measures (NTMs) have gained a more prominent role as trade and consumer protection tools in the current world economy. As a result, a number of databases have been developed. Six main NTM databases are readily available:

*UNCTAD's TRAINS* database was the first comprehensive database on NTMs. The database covers import (technical and non-technical measures) and export measures as well as information on "procedural obstacles" (e.g. administrative burdens, transparency issues or infrastructural challenges).

Information in TRAINS is coded in a binary form at the tariff line level, which bears the limitation that the data does not allow to distinguish between mild and stiff non-tariff measures.

NTMs information can also be retrieved from the *World Bank's TPP database*. This database provides information on a set of “core non-tariff trade barriers (NTBs)” including price-control, finance control, and quantity control measures. Variables included in the database consist of frequency measures, coverage ratios, and simple and import-weighted *ad-valorem* equivalents of NTMs at the HS 3-digit level.

The *CEPII's NTM-MAP database* is also based on the UNCTAD's TRAINS data and provides frequency measures, coverage ratios, and prevalence score ratios for technical barriers to trade (TBT), sanitary and phytosanitary (SPS) measures, pre-shipment inspections, contingent trade protective measures and non-automatic licensing, quotas, prohibitions, and quantity-control measures.

The *WTO Integrated Trade Intelligence Portal (I-TIP)* includes information on antidumping, countervailing measures, quantitative restrictions, safeguard measures, tariff rate quotas, export subsidies, TBT and SPS measures. In addition, information on specific trade concerns (STCs) raised in the WTO TBT and SPS committees are provided. All information available through I-TIP refers to countries' notifications to the WTO. As a result the availability of information for a given WTO country member depends on its compliance with the WTO's notification obligations.

The *WTO's Trade Monitoring database* gathers information about trade-related measures, such as trade remedies, export duties, and quantitative restrictions, implemented by WTO member countries following the 2008 global financial crisis.

Finally, the *Global Trade Alert database* reports policies that may affect trading partners' commercial interests, such as import tariffs, export incentives, export taxes, as well as other NTMs.

### **Specific non-tariff measures (NTMs) data**

Besides the NTMs databases presented above, several other databases focusing only on specific types of NTMs are available.

**Subsidies and government support measures.** The *OECD's Agricultural Policy database* accounts for different measures of agricultural support, such as the total support estimate, producer support estimate, consumer support estimate and general services support estimate (GSSE). Data are available from 1986 onwards.

The *WTO's Agriculture Information Management System* includes a series of measures notified by WTO member countries to the WTO Agricultural Committee, including export subsidies. These data are available from 1995 onwards. In addition, the WTO Consolidated Tariff Schedules (WTO-CTS) provides information about agricultural non-tariff commitments, which include tariff quotas and subsidies.



The *International Energy Agency (IEA)* website contains data about fossil fuel subsidies. The dataset covers oil, electricity, natural gas, coal and total fossil fuels in billions of real US dollars over the period 2012-2014. The data also include estimates for the average subsidisation rate (percent), subsidies per capita, and total subsidies as a share of GDP (percent).

Finally, the *World Bank* reports data about aggregated subsidies and other transfers in current local currency unit (LCU) by country from 1981 to 2015. Subsidies, grants, and other social benefits reported include all unrequited, non-repayable transfers on current account to private and public enterprises; grants to foreign governments, international organizations, and other government units; and social security, social assistance benefits, and employer social benefits in cash and in kind.

***Export restriction.*** The OECD has developed and maintains data aggregated at the 6-digit level of HS 2007 on export restrictions for primary agricultural products as well as raw materials (minerals, metals, and wood). Various kinds of export restrictions are reported, such as export duties, export prohibitions, and licensing requirements. Information on primary agriculture products covers the period 1996-2012, while data on raw materials restrictions are only available for the years 2009-2014.

***Safeguards and antidumping/countervailing measures.*** A series of useful databases, developed by Chad Bown and hosted by the World Bank's Temporary Trade Barriers Database (TTBD), provide information on safeguard, and antidumping and countervailing measures. The Global Antidumping (GAD) and the Global Countervailing Duties (GCVD) databases gather data for the period 1980-2015. The China-Specific Safeguards (CSFG) includes information for the period 2002-2015. The Global Safeguards (GSFG) and the WTO Dispute Settlement Understanding (WTO-DSU) Cases related to Antidumping, Safeguards or Countervailing Duties cover the period 1995-2015.

***Technical regulations and sanitary and phytosanitary measures.*** The WTO's TBT Information Management System (TBT-IMS) and SPS Information Management System (SPS-IMS) provide access to all the TBT and SPS measures notified by WTO member countries to the WTO as well as any documents submitted to and released in the respective WTO committee. In addition, both TBT- and SPS-IMS report various STCs raised by WTO country members in their respective committees. Other relevant sources of information on TBT, include Perinorm, which is a bibliographic database, developed by the British Standards Institution, the Association Française de Normalisation, and the Deutsches Institut für Normung, with information on national, European, and international standards in 23 countries.

***Services trade restrictiveness indices.*** The OECD Services Trade Restrictiveness Index (STRI) identifies policies restricting foreign entry and movement of people, and imposing barriers to competition and transparency as well as other measures. The World Bank's Services Trade Restrictions Database collects also information for different services trade policies in 103 countries and five main sectors (covering telecommunications, finance, transportation, retail, and professional services) and key modes of service supply for the period 2008-2010 (Borchert et al., 2012).

The I-TIP Services database, developed jointly by the WTO and World Bank, provides information on WTO members' commitments under the General Agreement on Trade in Services (GATS), RTAs

applied measures in services and service statistics for 12 groups and 160 sub-groups according to the Services Sectoral Classification List, developed during the Uruguay Round of the General Agreement on Tariffs and Trade (GATT).

**Trade facilitation restrictions.** Information on trade facilitation is available in various databases covering different types of information related to trade facilitation measures (WTO, 2015).

The World Bank's Doing Business database reports various "trading across borders" indicators relevant to trade facilitation. In particular, information on the respective time and costs to import and export due to documentary requirement, border compliance, and domestic transport is available for 189 countries for the period 2004 onwards.

The OECD Trade Facilitation Indicators (TFIs) covers 16 indicators strongly linked to the provisions of the WTO Trade Facilitation Agreement (TFA) provisions, such as advance ruling, appeal procedures, fees and charges, formalities (documents, automation, procedures), (internal and external) cooperation as well as transit (fees and charges, formalities, guarantees and agreements and cooperation). The TFIs database tracks the trade facilitation performance of 152 countries for the years 2009 and 2015.

The World Bank's Logistic Performance Index (LPI) focuses on the logistic friendliness of a country and ranks countries along six dimensions: customs; infrastructure; ease of arranging shipments; quality of logistics services; tracking and tracing; and timeliness. The database covers 160 countries for the following years: 2007, 2010, 2012 and 2014.

The World Economic Forum (WEF) Enabling Trade Index (ETI) assesses the extent to which economies have in place institutions, policies, infrastructure and services facilitating the flow of goods over borders and their destinations. The index includes 79 indicators grouped into 4 areas: market access; border administration; infrastructure; and operating environment.

### **Regional trade agreements**

When countries form a RTA not only do they apply lower tariffs, but they also cooperate on a number of other policy areas that reduce overall bilateral trade costs among member countries beyond the removal of explicit trade barriers. One way to take this information into account is by including as a covariate in a gravity equation a dummy indicating whether or not there is a trade agreement in place between a specific pair of countries.

The WTO Regional Trade Agreements Information System (RTA-IS) reports detailed information on RTAs notified to the WTO, including the agreement's nature (customs unions, free trade agreements, or partial scope agreements); scope (goods, services or goods and services); signature date; and signatory countries as well as links to the official documents. The WTO's preferential trade arrangements (PTA) database also provides information on unilateral trade agreements, namely agreements of non-reciprocal nature, such as the General System of Preferences (GSP) and sub-schemes for least-developed countries (LDCs). Data on preference utilization rates are also available through the WTO's Tariff Analysis Online interface.

Building on the information provided in the WTO RTA-IS, other databases on RTAs have been developed. For instance, the RTAs database, developed by Mario Larch and readily available in STATA format, covers 468 RTAs from 1950 onwards. Similarly, the database on Economic Integration Agreements (EIAs), developed by Jeffrey H. Bergstrand, categorizes the bilateral relationship for the pairings of 195 countries during the period 1950-2005 by applying a multi-faceted index that distinguishes between unilateral, bilateral agreements, RTA, customs unions and common markets.

While informative, an indicator variable of the existence of RTAs cannot capture the fact that RTAs also differ in terms of scope and types of specific provisions covered. In order to address this issue, indexes of the depth of RTAs can be built starting from basic information on the coverage of the agreement. The 2013 World Trade Report codified provisions for a set of 100 RTAs signed between 1958 and 2011 by extending the data developed by Horn et al. (2010). The different RTAs' provisions are classified into one of the 52 policy areas identified by the authors. Some of these policy areas are defined as "WTO+" provisions when the RTA's provisions fall under the WTO's current mandate, reconfirm existing commitments and specify additional related obligations. Conversely, other policy areas are denoted as "WTO-X" provisions when the RTA's provisions establish obligations that are outside the WTO's current mandate. The codification also ascertains the legal enforceability of the RTA's obligations by assuming that the clearer, more specific and imperative the legal language used to express a commitment or undertaking, the more successfully it can be invoked by a complainant in a dispute settlement proceeding, and thus the greater likelihood of it being enforced. Following this methodology, the World Bank's Global Preferential Trade Agreements (GPTA) extends the coverage of the RTAs to include 330 agreements. Data on RTAs' depth of integration can also be retrieved from the Design of Trade Agreements (DESTA) database, which covers 587 trade agreements for the period 1947-2010.

## C. Applications

This section highlights the usefulness, validity and applicability of the recommendations suggested in section B.2 by presenting a series of empirical applications estimating the impact of trade policies on trade, such as RTAs and MFN tariffs, within the structural gravity model. The purpose of these applications is primarily instructional. Therefore, the model specifications considered in each of the applications focus on the effects of specific covariates instead of specifying comprehensive sets of trade policy variables.

In order to emphasize the importance of the various considerations that should be taken into account when estimating the effects of trade policy, each application is presented as a sequence of estimating equations and corresponding results. For instructional purposes, examples of the main STATA commands used to implement each application are presented. Consistent with the recommendations formulated in section B.2, all estimation results are obtained with panel data with specific year intervals. In addition, standard errors in all estimations are clustered by trading pair in order to account for any intra-cluster correlations at the trading pair level.<sup>18</sup>

In all the applications presented in this chapter, the results are obtained from the same balanced panel data covering the aggregate manufacturing sector of 69 countries over the period 1986-2006.<sup>19</sup> The sample combines data from several sources. Most importantly, it includes

consistently constructed international and intra-national trade flows data, which were assembled and provided by Thomas Zylkin. The original sources for the international trade data are the UN COMTRADE database and the CEPII TradeProd database. COMTRADE is the primary data source and TradeProd is used for instances when it includes positive flows for observations when no trade flows are reported in COMTRADE. Intra-national trade for each country is constructed as the difference between total manufacturing production and total manufacturing exports. Importantly, both of these variables are reported on a *gross basis*, which ensures consistency between intra-national and international trade. Three sources are used to construct the production data: the UN UNIDO INDSTAT database, the CEPII TradeProd database, and the World Bank's TPP database.<sup>20</sup> The data on RTAs were taken from Mario Larch's Regional Trade Agreements Database. Finally, all standard gravity variables including distance, contiguous borders, common language, and colonial ties are from the CEPII GeoDist database. An important advantage of the GeoDist database is that the weighted-average methods used to construct distance ensure consistency between the measures of intra-national and international distance, because each method uses population-weighted distances across the major economic centres within or across countries, respectively.

## 1. Traditional gravity estimates

This first application discusses the estimates of the effects of traditional gravity variables by applying different methods to account for these multilateral resistance terms and different estimators (OLS and PPML estimators).

### (a) OLS estimation ignoring multilateral resistance terms

The analysis begins with an OLS estimation of the empirical specification that includes standard gravity variables with panel data with 4-year intervals:

$$\ln X_{j,t} = \beta_0 + \beta_1 \ln DIST_{ij} + \beta_2 CNTG_{ij} + \beta_3 LANG_{ij} + \beta_4 CLNY_{ij} + \beta_5 \ln Y_{i,t} + \beta_6 \ln E_{j,t} + \varepsilon_{j,t} \quad (1-23)$$

As is standard in the literature, the variable  $\ln X_{j,t}$  corresponds to the logarithm of nominal bilateral international trade flows from exporter  $i$  to importer  $j$  at time  $t$ .  $\beta_0$  is a constant term, whose structural interpretation is as world output. As defined in section B.2,  $\ln DIST_{ij}$  represents the logarithm of bilateral distance between trading partners  $i$  and  $j$ ,  $CNTG_{ij}$  is an indicator variable capturing the presence of contiguous borders between trading partners  $i$  and  $j$ ,  $LANG_{ij}$  denotes a dummy variable for the existence of a common official language between partners  $i$  and  $j$ , and  $CLNY_{ij}$  is an indicator for the presence of colonial ties between countries  $i$  and  $j$ . Finally, the covariates  $\ln Y_{i,t}$  and  $\ln E_{j,t}$  are the logarithms of the values of exporter output and importer expenditure, respectively.

As reported in column (1) of Table 1, the estimation results from specification (1-23) are overall as expected. With a  $R^2 = 0.76$ , the econometric specification delivers the standard strong fit that is commonly found in many empirical gravity models in the literature. The estimates on

all covariates in equation (1-23) are statistically significant and have the expected signs. The estimate of the effect of distance is statistically significant at any conventional level and virtually equal to the benchmark estimate of  $-1$ , as documented by Disdier and Head (2008) and Head and Mayer (2014), confirming that distance is a significant impediment to bilateral trade. The impact of sharing a common border, speaking the same official language, and sharing colonial ties on international trade are positive and statistically significant, in line with the literature.<sup>21</sup> Overall, the gravity estimates obtained here are widely accepted in the literature and, therefore, establish the representativeness of the sample.

The estimates on output and expenditure are, as expected, positive and statistically significant. Although the estimates of both variables are very close to one, as predicted by the structural gravity model, both of them are statistically different from one. A possible explanation for this result is that both output and expenditure covariates may account for dynamic forces in the panel specification (Olivero and Yotov, 2012). Finally, in terms of magnitude, each of the estimates reported in column (1) of Table 1 is readily comparable to the corresponding summary indexes developed by Head and Mayer (2014).

**Table 1** Traditional gravity estimates

	(1) OLS	(2) OLS <i>Remoteness</i>	(3) OLS <i>Fixed Effects</i>	(4) PPML <i>Fixed Effects</i>
Log distance	-1.002 (0.027)**	-1.185 (0.031)**	-1.216 (0.038)**	-0.841 (0.032)**
Contiguity	0.574 (0.185)**	0.247 (0.177)	0.223 (0.203)	0.437 (0.083)**
Common language	0.802 (0.082)**	0.739 (0.078)**	0.661 (0.082)**	0.247 (0.077)**
Colony	0.735 (0.144)**	0.842 (0.150)**	0.670 (0.149)**	-0.222 (0.116) <sup>+</sup>
Log output	1.190 (0.009)**	1.164 (0.010)**		
Log expenditure	0.908 (0.010)**	0.903 (0.010)**		
Exporter remoteness index		0.972 (0.068)**		
Importer remoteness index		0.274 (0.060)**		
Constant	-11.283 (0.296)**	-35.219 (1.986)**	1.719 (0.715) <sup>+</sup>	15.867 (0.214)**
Observations	25689	25689	25689	28152
$R^2$	0.759	0.765	0.843	0.614
<i>Exporter-time</i> fixed effects	No	No	Yes	Yes
<i>Importer-time</i> fixed effects	No	No	Yes	Yes
RESET test (p-value)	0.000	0.000	0.000	0.642

*Source:* Authors' calculations

*Notes:* All estimates are obtained with data for the years 1986, 1990, 1994, 1998, 2002, and 2006. Columns (1)-(3) use the OLS estimator. Column (1) does not control for the multilateral resistances. Column (2) uses "remoteness indexes" to control for multilateral resistances. Column (3) uses *importer-time* and *exporter-time* fixed effects, whose estimates are omitted for brevity, to control for multilateral resistances. Finally, column (4) employs the PPML estimator. Standard errors are clustered by country pair and are reported in parentheses. The  $p$ -values read as follows: <sup>+</sup>  $p < 0.10$ ; \*  $p < 0.05$ ; and \*\*  $p > 0.01$ .

```

* STATA commands to estimate standard gravity model with the OLS estimator and
* without intra-national trade flows:
generate ln_trade = ln(trade)
generate ln_DIST = ln(DIST)
generate ln_Y = ln(Y)
generate ln_E = ln(E)
regress ln_trade ln_DIST CNTG LANG CLNY ln_Y ln_E ///
        if exporter != importer, cluster(pair_id)

```

### (b) OLS estimation controlling for multilateral resistance terms with remoteness indexes

As famously demonstrated by Anderson and van Wincoop (2003), failure to account for the multilateral resistance terms may lead to severe biases in the estimates of the gravity variables. The following specification attempts to account for the multilateral resistances by considering the “remoteness indexes” mentioned in section B.2:<sup>22</sup>

$$\ln X_{j,t} = \beta_0 + \beta_1 \ln DIST_{ij} + \beta_2 CNTG_{ij} + \beta_3 LANG_{ij} + \beta_4 CLNY_{ij} + \beta_5 \ln Y_{i,t} + \beta_6 \ln E_{j,t} + \beta_7 \ln REM\_EXP_{i,t} + \beta_8 \ln REM\_IMP_{j,t} + \varepsilon_{j,t} \quad (1-24)$$

where the new covariates on the exporter side,  $\ln REM\_EXP_{i,t}$ , and on the importer side,  $\ln REM\_IMP_{j,t}$ , are constructed, respectively, as the logarithms of output- and expenditure-weighted averages of bilateral distance (Head, 2003):

$$\ln REM\_EXP_{i,t} = \ln \left( \frac{\sum_j DIST_{ij}}{Y_t} \right) \quad (1-25)$$

$$\ln REM\_IMP_{j,t} = \ln \left( \frac{\sum_i DIST_{ij}}{Y_t} \right) \quad (1-26)$$

Estimates from specification (1-24) are reported in column (2) of Table 1. Three main findings stand out. First, the estimates of the effects of the standard gravity variables and the activity covariates are qualitatively identical to those from column (1). The only notable difference is that the estimate on contiguity is no longer statistically significant in the new specification. Second, the estimates of the effects of distance are stronger in column (2) than in column (1), while the estimates of the effects of contiguity and common official language are smaller. These results suggest that the estimates from column (1), which did not account for the multilateral resistances, were indeed biased as suggested by Anderson and van Wincoop (2003). Finally, in accordance with the literature, the estimates of the remoteness indexes are positive, large and highly significant, confirming that, all else equal, regions that are more isolated/remote from the rest of the world tend to trade more with each other.

```

* STATA commands to estimate gravity model with the OLS estimator and remoteness indexes:
  bysort exporter year: egen TotEj = total(E)
  bysort year: egen TotE = max(TotE)
  bysort exporter year: egen REM_EXP = total(DIST / (E / TotE))
  generate ln_REM_EXP = ln(REM_EXP)
  bysort importer year: egen TotYi = total(Y)
  bysort year: egen TotOUT = max((TotYi)
  bysort importer year: egen REM_IMP = total(DIST / (Y / TotY))
  generate REM_IMP = ln(REM_IMP)
  regress ln_trade ln_DIST CNTG LANG CLNY ln_Y ln_E ln_REM_EXP ///
  ln_REM_IMP if exporter != importer, cluster(pair_id)

```

### (c) OLS estimation controlling for multilateral resistance terms with fixed effects

Consistent with the recommendation formulated in section B.2, the gravity specification (1-23) is modified to account for the multilateral resistances with an appropriate set of *exporter-time* and *importer-time* fixed effects:

$$\ln X_{j,t} = \pi_{i,t} + \chi_{j,t} + \beta_1 \ln DIST_{ij} + \beta_2 CNTG_{ij} + \beta_3 LANG_{ij} + \beta_4 CLNY_{ij} + \varepsilon_{j,t} \quad (1-27)$$

The term  $\pi_{i,t}$  denotes the vector of *exporter-time* fixed effects, which will account for the outward multilateral resistances. Similarly, the vector  $\chi_{j,t}$  denotes the set of *importer-time* fixed effects to capture the inward multilateral resistances. No constant term is included in the presence of the fixed effects. By definition, both *exporter-time* and *importer-time* fixed effects will absorb, respectively, the exporter value of output and importer expenditure, as well as all other observable and unobservable exporter- and importer-specific characteristics that may influence bilateral trade.

```

* STATA commands to estimate gravity model with the OLS estimator and exporter- and
* importer-time effects:
  egen exp_time = group(exporter year)
  tabulate exp_time, generate(EXPORTER_TIME_FE)
  egen imp_time = group(importer year)
  tabulate imp_time, generate(IMPORTER_TIME_FE)
  regress ln_trade EXPORTER_TIME_FE* IMPORTER_TIME_FE* ln_DIST CNTG LANG CLNY ///
  if exporter != importer, cluster(pair_id)

```

The estimates from specification (1-27), reported in column (3) of Table 1, reinforce the message from the results in column (2), which only partially controlled for multilateral resistances. The estimate of the negative impact of distance on trade flows from column (3) is larger than the corresponding numbers from columns (1) and (2), while the estimates of the effects of contiguous borders and common official language decrease further relative to the results from columns (1) and (2). Overall, these results confirm the importance of accounting properly for multilateral resistances in order to obtain consistent gravity estimates.

### (d) PPML estimation controlling for multilateral resistance terms with fixed effects

Following the last recommendation suggested in section B.2, the gravity specification (1-27), which accounts for the full set of *exporter-time* and *importer-time* fixed effects, is reformulated in multiplicative form and re-estimated by applying the PPML estimator instead of the OLS estimator:

$$X_{j,t} = \exp\left[\pi_{i,t} + \chi_{j,t} + \beta_1 \ln DIST_{ij} + \beta_2 CNTG_{ij} + \beta_3 LANG_{ij} + \beta_4 CLNY_{ij}\right] \times \varepsilon_{j,t} \quad (1-28)$$

The PPML estimates from specification (1-28) listed in column (4) of Table 1 point to two important findings. First, comparison between the OLS estimates in column (3) and the PPML estimates in column (4) reveals significant differences in terms of magnitudes, significance, and even signs. Overall, and despite the different samples used, the results presented here are very similar to those reported in Table 5 of Santos Silva and Tenreyro (2006). Specifically, as compared to the estimated coefficients associated with the OLS estimation, the PPML estimate of the effect of distance is significantly smaller in absolute value. Similarly, the estimate of contiguous borders becomes statistically significant, and the estimate of common language decreases in magnitude but remains significant. Although the estimate of the effects of colony decrease in magnitude in both studies, it becomes negative and marginally significant here compared to Santos Silva and Tenreyro (2006). Second, and more important, the *p*-values of the Ramsey RESET test, reported at the bottom of Table 1, reveal that the PPML specification is the only one to pass the misspecification test.<sup>23</sup> Overall, these estimates favour the PPML estimator over the OLS estimator.

```
* STATA commands to estimate gravity model with the PPML estimator and exporter- and
* importer-time effects:
ppml trade EXPORTER_TIME_FE* IMPORTER_TIME_FE* ln_DIST CNTG LANG CLNY ///
    if exporter != importer, cluster(pair_id)
```

## 2. The “distance puzzle” resolved

Despite its popularity and great predictive power, the gravity model has been subject to significant criticism on the ground that gravity estimates fail to capture the effects of globalization on international trade. Based on a meta-analysis of a rich data set of 1,467 distance estimates from gravity equations from 103 papers, Disdier and Head (2008) conclude that the estimated negative impact of distance on trade has remained persistently high, even after controlling for many important differences in samples and methods.<sup>24</sup> This finding, known as the “distance puzzle” in international trade, is in direct contradiction with the empirical evidence of declining trade-related costs (Coe et al., 2002).

This application applies the methods developed by Yotov (2012) in order to solve the “distance puzzle” of trade. In particular, capitalizing on the properties of the structural gravity model, Yotov (2012) recognizes that the structural gravity system can only ever identify relative trade costs. Therefore, studies that only use international trade data cannot resolve the distance puzzle, because the effects of distance on international trade are measured relative to other international trade costs. Yotov (2012) proposes to measure the effects of distance and globalization relative to internal trade costs



and demonstrates that the “distance puzzle” disappears when, consistent with gravity theory, *internal trade* and *internal distance* are explicitly accounted for in the standard gravity specification. In fact, an empirical model allowing for a decrease in international trade costs relative to *internal* trade costs is more likely to capture the effects of globalization than a model analysing the impact of trade costs relative to a reference group that has been affected similarly (equally) by globalization.

For expositional clarity and instructional purposes, the analysis is presented sequentially. The first set of results capture the “distance puzzle” as described in the literature. The following results address the “distance puzzle” and reproduce some of the estimates found in Borchert and Yotov (2016).

### (a) Uncovering the “distance puzzle”

The analysis starts with an OLS estimation of the gravity model with 4-year interval data. The empirical specification includes traditional gravity covariates, including *exporter-time* and *importer-time* fixed effects, and considers only international trade flows (i.e. for  $i \neq j$ ), as is standard in the literature:

$$\ln X_{j,t} = \pi_{i,t} + \chi_{j,t} + \sum_{T=1986}^{2006} \beta_T \ln DIST\_ (T)_{ij} + \beta_2 CNTG_{ij} + \beta_3 LANG_{ij} + \beta_4 CLNY_{ij} + \varepsilon_{j,t} \quad (1-29)$$

In order to determine the change in the impact of the distance variable on trade, the model specification allows for different effects of distance in each of the six years, considered in the analysis  $T \in \{1986, 1990, 1994, 1998, 2002, 2006\}$ . As highlighted in column (1) of Table 2, the negative impact of distance on bilateral trade has actually increased by 7.95 percent between 1986 and 2006, confirming the presence of the “distance puzzle” in the sample.

In accordance with the last recommendation suggested in section B.2, the gravity specification (1-29) is re-estimated in multiplicative form by applying the PPML estimator to the same sample (with international trade only):

$$X_{j,t} = \exp \left[ \pi_{i,t} + \chi_{j,t} + \sum_{T=1986}^{2006} \beta_T \ln DIST\_ (T)_{ij} + \beta_2 CNTG_{ij} + \beta_3 LANG_{ij} + \beta_4 CLNY_{ij} \right] \times \varepsilon_{j,t} \quad (1-30)$$

As reported in column (2) of Table 2, the estimate of the effect of distance in 2006 is only marginally smaller in absolute value than the one associated with the distance variable for 1986. Yet, the  $-2.75$  percent change in the distance estimate between 1986 and 2006 is statistically not different from zero, confirming once again that the data is subject to the “distance puzzle”.

### (b) Solving the “distance puzzle”

Following the recommendations proposed in Section B.2, the gravity specification (1-30) is modified to consider *international* and *intra-national* trade data, and to include a measure of *intra-national* distance,  $\ln DIST\_ INTRA_{ij}$ , taking the value of zero for international trade flows (for  $i \neq j$ ):

$$X_{j,t} = \exp \left[ \pi_{i,t} + \chi_{j,t} + \sum_{T=1986}^{2006} \beta_T \ln DIST\_ (T)_{ij} + \beta_2 CNTG_{ij} + \beta_3 LANG_{ij} \right] \times \exp \left[ \beta_4 CLNY_{ij} + \beta_5 \ln DIST\_ INTRA_{ij} \right] \times \varepsilon_{j,t} \quad (1-31)$$

**Table 2** A simple solution to the “distance puzzle” in trade

	(1) OLS	(2) PPML	(3) INTRA	(4) BRDR	(5) FE <sub>s</sub>
Log distance 1986	-1.168 (0.044)**	-0.859 (0.037)**	-0.980 (0.072)**	-0.857 (0.063)**	-0.910 (0.032)**
Log distance 1990	-1.155 (0.042)**	-0.834 (0.038)**	-0.940 (0.073)**	-0.819 (0.063)**	-0.879 (0.032)**
Log distance 1994	-1.211 (0.046)**	-0.835 (0.035)**	-0.915 (0.072)**	-0.796 (0.063)**	-0.860 (0.032)**
Log distance 1998	-1.248 (0.043)**	-0.847 (0.035)**	-0.887 (0.071)**	-0.770 (0.063)**	-0.833 (0.032)**
Log distance 2002	-1.241 (0.044)**	-0.848 (0.032)**	-0.884 (0.071)**	-0.767 (0.063)**	-0.829 (0.032)**
Log distance 2006	-1.261 (0.044)**	-0.836 (0.031)**	-0.872 (0.071)**	-0.754 (0.062)**	-0.811 (0.032)**
Contiguity	0.223 (0.203)	0.437 (0.083)**	0.371 (0.140)**	0.574 (0.155)**	0.442 (0.082)**
Common language	0.661 (0.082)**	0.248 (0.077)**	0.337 (0.168)*	0.352 (0.137)*	0.241 (0.076)**
Colony	0.670 (0.149)**	-0.222 (0.116)+	0.019 (0.156)	0.027 (0.125)	-0.220 (0.117)+
Log intra-national distance			-0.488 (0.101)**	-0.602 (0.109)**	
Intra-national trade dummy				1.689 (0.574)**	
Observations	25689	28152	28566	28566	28566
Percent change in log distance between 1986 and 2006	7.950 (3.759)*	-2.750 (3.004)	-10.965 (1.058)**	-11.969 (1.173)**	-10.931 (0.769)**
<i>Intra-national</i> trade	No	No	Yes	Yes	Yes
Country-specific <i>intra-national</i> fixed effects	No	No	No	No	Yes

Source: Authors' calculations

Notes: All estimates are obtained with data for the years 1986, 1990, 1994, 1998, 2002, and 2006, and use *exporter-time* and *importer-time* fixed effects. The estimates of the fixed effects are omitted for brevity. Columns (1) and (2) use data on international trade flows only. Column (1) employs the OLS estimator and column (2) uses the PPML estimator. Column (3) adds *internal* trade observations and uses *intra-national* distance as an additional covariate. Column (4) adds an indicator covariate for international trade. Finally, column (5) uses country-specific dummies for *intra-national* trade. Standard errors are clustered by country pair and are reported in parentheses. The bottom panel of the table reports the percentage change in the estimates of the effects of bilateral distance between 1986 and 2006. Standard errors for the percentage changes are obtained with the delta method. The *p*-values read as follows: + *p* < 0.10; \* *p* < 0.05; and \*\* *p* > 0.01.

Two main results stand out from the PPML estimates of the gravity specification (1-31) reported in column (3) of Table 2. First, the impact of internal distance on domestic sales is much smaller as compared to the distance effects on international trade (where by definition the log of distance for intra-national trade is zero). This is consistent with the estimates reported in Anderson et al. (2016c) for the effects of intra-provincial vs. international distance in the case of Canada, confirming Head and Mayer's (2013) argument that international distance accounts for a host of obstacles to trade. Second, and more important for the current purposes, the results show a statistically significant decrease of -10.965 percent of the effects of distance on trade between 1986 and 2006, solving thus the “distance puzzle”.

```

* STATA commands to estimate gravity model with international and intra-national trade:
* Create variable for the log of internal distance
generate SMCTRY = 1 if exporter == importer
    replace SMCTRY = 0 if SMCTRY == .
generate ln_DIST_INTRA = ln_DIST*SMCTRY
forvalues Year = 1986(1)2006 {
    replace ln_DIST_`Year' = 0 if SMCTRY == 1
}
* Estimate the gravity model
ppml trade EXPORTER_TIME_FE* IMPORTER_TIME_FE* ln_DIST_1986 ln_DIST_1990 ///
    ln_DIST_1994 ln_DIST_1998 ln_DIST_2002 ln_DIST_2006 CNTG LANG CLNY ///
    ln_DIST_INTRA, cluster(pair_id)

```

Next, the gravity specification (1-31) is modified to better account for potential forces affecting international relative to internal trade in addition to distance (Borchert and Yotov, 2016):<sup>25</sup>

$$\begin{aligned}
 X_{j,t} = & \exp \left[ \pi_{i,t} + \chi_{j,t} + \sum_{T=1986}^{2006} \beta_T \ln DIST_{(T)ij} + \beta_2 CNTG_{ij} + \beta_3 LANG_{ij} + \beta_4 CLNY_{ij} \right] \times \\
 & \exp \left[ \beta_5 \ln DIST_{INTRA_{ij}} + \beta_6 SMCTRY_{ij} \right] \times \varepsilon_{j,t}
 \end{aligned} \tag{1-32}$$

The additional dummy variable  $SMCTRY_{ij}$ , taking the value of one for *intra-national* trade and zero for *international* trade, is motivated by three reasons. First, the covariate  $SMCTRY_{ij}$  enables to distinguish home bias effects and the fact that domestic trade tends to be much larger than international trade. Second, the variable  $SMCTRY_{ij}$  can potentially capture any other effects affecting international trade differentially that have not been covered by the other covariates of the model. Finally, as noted by Anderson and Yotov (2010a), the dummy variable  $SMCTRY_{ij}$  has the advantage of being an exogenous variable that controls for all the relevant forces that discriminate between *intra-national* and *international* trade. Consistent with the standard treatment of internal trade costs in the trade literature, a common coefficient is assigned to the variable  $SMCTRY_{ij}$ , which can be interpreted as setting the elasticity of *intra-national* trade costs to be equal across countries in the sample.

Three findings stand out from the PPML estimates of the gravity specification (1-32) listed in column (4) of Table 2. First, as expected, the impact of the variable  $SMCTRY_{ij}$  is large, positive, and statistically significant, suggesting a significant "home bias" with *intra-national* trade about  $\exp(1.689) = 5.5$  times larger than international trade. This estimate is significantly smaller compared to the famous border estimate of 22 for inter-provincial trade within Canada relative to international trade between Canadian provinces and US states reported in McCallum (1995). The proper econometric specification of the structural gravity model (i.e. controlling for the multilateral resistance terms as suggested by Anderson and van Wincoop (2003)) may explain this result. Second, although the impact of international distance and internal distance, respectively, falls and increases, in absolute magnitude, they both converge toward each other in terms of magnitude. The intuition for this result is twofold. First, international distance has indeed been capturing more than just the effects of transportation costs. Second, the estimate on internal distance reported in column (3) has also been capturing "home bias" effects. Finally, and most important, the effects of distance have decreased by 11.969 percent between 1986 and 2006, implying that the "distance puzzle" has once again disappeared.

Following the recommendations formulated in Section B.2, the last and most comprehensive gravity specification considered for the purpose of this application is modified to include country-specific fixed effects for *intra-national* trade ( $\mu_{ij}$ ):

$$X_{ij,t} = \exp \left[ \mu_{ij} + \pi_{i,t} + \chi_{j,t} + \sum_{T=1986}^{2006} \beta_T \ln DIST_{-}(T)_{ij} + \beta_2 CNTG_{ij} + \beta_3 LANG_{ij} + \beta_4 CLNY_{ij} \right] \times \varepsilon_{ij,t} \quad (1-33)$$

The country-specific fixed effects  $\mu_{ij}$  are defined as dummy variables taking the value of one for *intra-national* trade and zero otherwise. As such, due to perfect collinearity, they will absorb the *intra-national* distance and trade variables ( $\ln DIST\_INTRA_{ij}$  and  $SMCTRY_{ij}$ ). Therefore, the fixed effects  $\mu_{ij}$  control for country-specific intra-national trade costs and “home-bias” effects, as well as any other country-specific time-invariant characteristics that may drive a wedge between internal and international trade.

As reported in column (5) of Table 2, the PPML estimation results of specification (1-33) reveal that the effects of distance are smaller compared to the estimates from the previous specification that accounts for internal distance. This finding confirms the fact that the estimates of the effects of distance in standard gravity regressions reflect more than just the effects of transportation costs. The results also confirm the absence of the “distance puzzle” with a statistically significant reduction of 10.931 percent of the effects of distance between 1986 and 2006.

```
* STATA commands to estimate gravity model with intra-national trade fixed effects:
egen intra_pair = group(exports) if exports == imports
replace intra_pair = 0 if intra_pair == .
tabulate intra_pair, generate(INTRA_FE)
ppml trade INTRA_FE* EXPORTER_TIME_FE* IMPORTER_TIME_FE* ln_DIST_1986 ///
ln_DIST_1990 ln_DIST_1994 ln_DIST_1998 ln_DIST_2002 ln_DIST_2006 CNTG ///
LANG CLNY, cluster(pair_id)
```

### 3. Regional trade agreements effects

In the last 25 years, the number of RTAs has increased more than four-fold, to more than 450 agreements notified to the WTO. In this context, the objective of this application is to obtain estimates of the effects of RTAs on trade.<sup>26</sup> The analysis starts with a basic OLS specification. Then, capitalizing on various contributions from the literature, each additional step introduces a new feature to the initial specification.

#### (a) Traditional estimates of RTAs

The analysis starts with an OLS estimation of the gravity model with 4-year interval data. The empirical specification includes traditional gravity covariates, including *exporter-time* and *importer-time* fixed effects, and considers only international trade flows (i.e. for  $i \neq j$ ), as is standard in the literature:

$$\ln X_{ij,t} = \pi_{i,t} + \chi_{j,t} + \beta_1 \ln DIST_{ij} + \beta_2 CNTG_{ij} + \beta_3 LANG_{ij} + \beta_4 CLNY_{ij} + \beta_5 RTA_{ij,t} + \varepsilon_{ij,t} \quad (1-34)$$

The covariate  $RTA_{ij,t}$  is a dummy variable that takes a value of one if countries  $i$  and  $j$  are partners in a RTA at time  $t$ , and zero otherwise. Two main findings of the OLS estimates reported in Table 3 stand out. First, the estimates of the effects of the standard gravity variables are in accordance with theory and consistent with the findings reported in the previous applications. Second, interestingly, the results suggest that RTAs play no statistically significant role in promoting international trade. One possible explanation for the small (in fact negative) and not statistically significant coefficient of the variable  $RTA$  could be that specification (1-34) does not account properly for the potential endogeneity of RTAs. This issue is addressed in subsequent specifications.

But first, following the last recommendation suggested in section B.2, the gravity specification (1-34) is re-formulated in multiplicative form and re-estimated by applying the PPML estimator to the same sample (with international trade only):

$$\ln X_{ij,t} = \exp[\pi_{i,t} + \chi_{j,t} + \beta_1 \ln DIST_{ij} + \beta_2 CNTG_{ij} + \beta_3 LANG_{ij} + \beta_4 CLNY_{ij} + \beta_5 RTA_{ij,t}] \times \varepsilon_{ij,t} \quad (1-35)$$

As reported in column (2) of Table 3, the PPML estimates of the standard gravity variables are virtually identical to the corresponding numbers from specification (1-28), which does not control for the covariate  $RTA$  and is listed in column (4) of Table 1. This finding suggests that the omission of the variable  $RTA$  has not heavily biased the estimates of the model specifications considered in the first application. In addition, the positive and significant estimate of the effects of RTAs ( $\hat{\beta}_5 = 0.191$ ) suggests that, all else equal, RTAs increase trade between member countries by about  $[\exp(\hat{\beta}_5) - 1] \times 100 = [\exp(0.191) - 1] \times 100 = 21$  percent. Although the estimated coefficient of the variable  $RTA$  is positive and statistically significant, it is significantly smaller than corresponding numbers found in the literature (Baier and Bergstrand, 2007; Anderson and Yotov, 2016).

### (b) Allowing for trade-diversion from domestic sales

Following Dai et al. (2014) and Anderson and Yotov (2016), the gravity specification (1-35) is re-estimated by expanding the sample to include *intra-national* trade flows data in addition to *international* trade flows. The idea is that RTAs may be diverting trade from domestic to international sales and, therefore, the estimates of the variable  $RTA$  that are based on *international* trade only may be biased downward. As reported in column (3) of Table 3, the estimates of the standard gravity variables based on the sample with *international* and *intra-national* trade are statistically not different from the corresponding estimated parameters based on the sample with *international* trade only and listed in column (2) of Table 3. However, and more importantly, the results in column (3) show that extending the sample to include *intra-national* trade increases the estimated effect of RTAs, which has more than doubled in magnitude (from  $\hat{\beta}_5 = 0.191$  to  $\hat{\beta}_5 = 0.409$ ). This finding supports the hypothesis that RTAs enhance trade between members at the expense of domestic sales.

**Table 3** Estimating the Effects of Regional Trade Agreements

	(1)	(2)	(3)	(4)	(5)	(6)	(7)
	<i>OLS</i>	<i>PPML</i>	<i>INTRA</i>	<i>ENDG</i>	<i>LEAD</i>	<i>PHSNG</i>	<i>GLBZN</i>
Log distance	-1.216 (0.039)**	-0.822 (0.031)**	-0.800 (0.030)**				
Contiguity	0.223 (0.203)	0.416 (0.083)**	0.393 (0.079)**				
Common language	0.661 (0.082)**	0.250 (0.077)**	0.244 (0.077)**				
Colony	0.670 (0.149)**	-0.205 (0.114)+	-0.182 (0.113)				
RTA	-0.004 (0.054)	0.191 (0.066)**	0.409 (0.069)**	0.557 (0.102)**	0.520 (0.086)**	0.291 (0.089)**	0.116 (0.087)
RTA( <i>t</i> + 4)					0.077 (0.092)		
RTA( <i>t</i> - 4)						0.414 (0.067)**	0.288 (0.062)**
RTA( <i>t</i> - 8)						0.169 (0.043)**	0.069 (0.048)
RTA( <i>t</i> - 12)						0.119 (0.030)**	0.002 (0.029)
International border 1986							-0.706 (0.048)**
International border 1990							-0.480 (0.043)**
International border 1994							-0.367 (0.033)**
International border 1998							-0.158 (0.023)**
International border 2002							-0.141 (0.017)**
Observations	25689	28152	28566	28482	28482	28482	28482
Total RTA effect						0.992 (0.094)**	0.475 (0.109)**
Intra-national trade	No	No	Yes	Yes	Yes	Yes	Yes

*Source:* Authors' calculations

*Notes:* All estimates are obtained with data for the years 1986, 1990, 1994, 1998, 2002, and 2006, and use exporter-time and importer-time fixed effects. The estimates of the fixed effects are omitted for brevity. Columns (1) and (2) use data on *international* trade flows only. Column (1) applies the OLS estimator and column (2) uses the PPML estimator. Column (3) adds *intra-national* trade observations and uses country-specific dummies for internal trade. Column (4) adds pair fixed effects. The estimates of the pair fixed effects are omitted for brevity. Column (5) introduces RTA lead. Column (6) allows for phasing-in effects of RTAs. Finally, column (7) accounts for the effects of globalization. Standard errors are clustered by country pair and are reported in parentheses. The *p*-values read as follows: +  $p < 0.10$ ; \*  $p < 0.05$ ; and \*\*  $p > 0.01$ .

### (c) Addressing potential endogeneity of RTAs

As noted previously, failure to address the potential endogeneity of RTAs may bias the gravity estimates. Following Baier and Bergstrand (2007), the gravity specification (1-35) is modified to include pair fixed effects ( $\mu_{ij}$ ) in addition to the theoretically-motivated *importer-time* and *exporter-time* fixed effects:

$$X_{j,t} = \exp[\pi_{i,t} + \chi_{j,t} + \mu_{ij} + \beta_5 RTA_{j,t}] \times \varepsilon_{j,t} \quad (1-36)$$

Because of perfect collinearity, using pair fixed effects ( $\mu_{ij}$ ) does not allow to include in the model, and therefore estimate, any of the standard gravity variables that do not vary over time (distance, contiguity, common language and colonial ties). In addition, one of the bilateral fixed effects has to be dropped from the model specification. For practical purposes, the fixed effect for *intra-national* trade  $\mu_{ii}$ , captured by the variable  $SMCTRY_{ii}$  defined in the application 2, is removed from specification (1-36).<sup>27</sup> In effect, this implies that all internal trade costs are set to one and all *international* fixed effects  $\mu_{ij}, j \neq i$ , are estimated relative to the *intra-national* fixed effect  $\mu_{ii}$ .

```
* STATA commands to estimate gravity model with the country-pair fixed effects:
egen pair_id = group(exports importer)
tabulate pair_id, generate(PAIR_FE)
ppml trade PAIR_FE* EXPORTER_TIME_FE* IMPORTER_TIME_FE* RTA, cluster(pair_id)
```

The PPML estimation results, which are obtained with pair fixed effects, are reported in column (4) of Table 3. Although not presented in column (4), the estimates of all pair fixed effects are negative and smaller than -1, reflecting the fact that the pair fixed effects absorb all trade costs and that *international* trade costs are larger than *intra-national* trade costs. More importantly for the purpose of the application, the coefficient of the variable *RTA* is statistically significant and positive, and much larger ( $\hat{\beta}_5 = 0.557$ ) than the estimated coefficient obtained with the previous specifications. The positive and highly significant estimate of the effects of RTAs is in accordance with Baier and Bergstrand's (2007) predictions that the estimates of the RTAs impact on trade obtained without proper account for endogeneity are biased downward.<sup>28</sup> The estimated coefficient of the variable *RTA* reported in column (4) suggests that, all else equal, the formation of RTAs leads to an average increase of about  $[\exp(0.577) - 1] \times 100 = 75$  percent in international trade between members, which is much closer to existing estimates from the literature.

### (d) Testing for potential “reverse causality” between trade and RTAs

In order to test whether specification (1-36) has properly accounted for possible “reverse causality” between trade and RTAs through the pair fixed effects, an easy test can be implemented to assess the “strict exogeneity” of RTAs by adding a new variable capturing the future level of RTAs,  $RTA_{j,t+4}$  to specification (1-36) (Wooldridge, 2010; Baier and Bergstrand, 2007):

$$X_{j,t} = \exp[\pi_{i,t} + \chi_{j,t} + \mu_{ij} + \beta_5 RTA_{j,t} + \beta_6 RTA_{j,t+4}] \times \varepsilon_{j,t} \quad (1-37)$$

If RTAs are exogenous to trade flows, the parameter  $\beta_6$  associated with the variable  $RTA_{j,t+4}$  should be statistically not different from zero. As shown in column (5) of Table 3, the PPML estimate of

the “future lead” of RTAs is neither economically nor statistically different from zero, confirming the absence of “reverse causality” in the results associated with specification (1-36).

```
* STATA commands to estimate gravity model with lead-in RTA variable:
  tsset pair_id year
  generate RTA_LEAD4 = f4.RTA
  replace RTA_LEAD4 = 0 if RTA_LEAD4 == .
  ppml trade PAIR_FE* EXPORTER_TIME_FE* IMPORTER_TIME_FE* RTA ///
  RTA_LEAD4, cluster(pair_id)
```

### (e) Allowing for potential non-linear and phasing-in effects of RTAs

In order to allow for non-linear effects of RTAs and/or to capture the possibility that the effects of RTAs change over time, specification (1-36) is further modified to include various lags (up to 12 years) of the variable *RTA*:

$$X_{ij,t} = \exp\left[\pi_{i,t} + \chi_{j,t} + \mu_j + \beta_5 RTA_{ij,t} + \beta_6 RTA_{ij,t-4} + \beta_7 RTA_{ij,t-8} + \beta_8 RTA_{ij,t-12}\right] \times \varepsilon_{ij,t} \quad (1-38)$$

As highlighted in column (6) of Table 3, the estimated coefficients of the three lagged *RTA* variables point to strong phasing-in effects of RTAs, which is consistent with findings from existing related studies (Baier and Bergstrand, 2007; Anderson and Yotov, 2011). In particular, the results suggest a non-monotonic relationship, where the relatively small average effects of RTAs over the first four years after the RTAs' entry into force more than double in the second four-year period, and decrease almost three times as compared to their peak after twelve years. That being said, the effects of RTAs remain significant twelve years after their implementation, which explains why the overall RTA effect, reported at the bottom of column (6) of Table 3, is strong and statistically significant.

```
* STATA commands to estimate gravity model with lagged RTA variables and compute the total
* RTA effects and associated standard errors with delta method:
  tsset pair_id year
  forvalues t = 4(4)12 {
    generate RTA_LAG`t' = L`t'.RTA
    replace RTA_LAG`t' = 0 if RTA_LAG`t' == .
  }
  ppml trade PAIR_FE* EXPORTER_TIME_FE* IMPORTER_TIME_FE* RTA RTA_LAG4 RTA_LAG8 ///
  RTA_LAG12, cluster(pair_id)
  lincom _b[RTA]+_b[RTA_LAG4]+_b[RTA_LAG8]+_b[RTA_LAG12]
```

### (f) Addressing globalization effects

The final experiment applies the methods developed by Bergstrand et al. (2015) to test and account for the possibility that the estimated effects of RTAs from specification (1-38) may be biased upward because they capture globalization effects, such as technology and innovation. Specifically, specification (1-38) is adjusted to include a set of new indicator variables capturing the existence of international borders between countries *i* and *j* for each year *T*:



$$X_{j,t} = \exp \left[ \pi_{i,t} + \chi_{j,t} + \mu_{ij} + \beta_5 RTA_{ij,t} + \beta_6 RTA_{ij,t-4} + \beta_7 RTA_{ij,t-8} + \beta_8 RTA_{ij,t-12} \right] \times \exp \left[ \sum_{T=1986}^{2002} \beta_T INTL\_BRDR\_ (T)_{ij} \right] \times \varepsilon_{j,t} \quad (1-39)$$

The new covariate,  $INTL\_BRDR\_ (T)_{ij}$ , is a dummy variable taking the value of one for international trade for each year  $T$ , and zero otherwise. Because of perfect collinearity with the rest of the fixed effects included in specification (1-39), it is impossible to estimate these international border dummies for all the years in the sample. For practical purposes, the international border dummy for 2006,  $INTL\_BRDR\_ 2006$ , is dropped from specification (1-39). As a result, the estimated coefficients of the other border dummy variables  $INTL\_BRDR\_ (T)$  for the years  $T \in \{1986, 1990, 1994, 1998, 2000, 2002\}$ , should be interpreted relative to the corresponding estimate for 2006.

```
* STATA commands to estimate gravity model with international border variables:
generate INTL_BRDR = 1 if exporter != importer
replace INTL_BRDR = 0 if INTL_BRDR == .
forvalues Year = 1986(1)2006 {
generate INTL_BRDR_`Year' = 1 if INTL_BRDR == 1 & year == `Year'
replace INTL_BRDR_`Year' = 0 if INTL_BRDR_`Year' == .
}
ppml trade PAIR_FE* EXPORTER_TIME_FE* IMPORTER_TIME_FE* RTA RTA_LAG4 RTA_LAG8 ///
RTA_LAG12 INTL_BRDR_1986 INTL_BRDR_1990 INTL_BRDR_1994 INTL_BRDR_1998 ///
INTL_BRDR_2002, cluster(pair_id)
lincom _b[RTA]+_b[RTA_LAG4]+_b[RTA_LAG8]+_b[RTA_LAG12]
```

Two main findings stand out from the estimates of specification (1-39) reported in column (7) of Table 3. First, the estimated coefficients of the different RTAs variables remain positive, even though they all decrease in magnitude. Furthermore, only the estimate of the first lagged RTA variable ( $RTA_{ij,t-4}$ ) remains statistically significant. This result suggests that, once globalization forces are accounted for, not only the impact of RTAs takes time to show up in the data but it also phases-in faster. This explains why the total estimated RTA effects, reported at the bottom of column (7), are slashed in half once globalization forces are explicitly taken into account in the model specification. This result, consistent with Bergstrand et al. (2015), suggests that the estimates of RTAs in the previous specifications may have indeed captured the effects of globalization.

Second, the estimates of the international border variables reveal that borders have fallen significantly over time. To see this point, note that the border estimates should be interpreted as deviations from the international border effect in 2006, defined as the reference group. For example, the estimated coefficient of the dummy variable  $INTL\_BRDR\_ 1986$  suggests that the effects of borders on trade in 1986 were  $\exp(0.706) = 2.03$  larger than the corresponding effects in 2006. Overall, the estimates of the trend in the international border dummies are similar to those reported in Bergstrand et al. (2015) confirming a steady and strong effect of globalization on trade over time.

## D. Exercises

### 1. Estimating the effects of WTO accession

The aim of this exercise is to assess the impact on trade of the accession to the WTO. A similar exercise can be applied to any other trade agreement provided the sample period covers sufficient years before and after the agreement. The STATA do-file "WTOAccession.do" providing the solution to the exercise can be found in "Chapter1\Exercises\".

(i) Preliminaries

- Open the data file "Chapter1Exercise1.dta".
- Create a histogram reporting the frequency of the number of the member countries of the WTO by year of accession.

*Hints: hist*

(ii) Benchmark gravity estimation

- Generate exporter-time and importer-time effects.
- Hints: generate*
- Estimate the following standard gravity specification by considering only *international* trade flows (i.e. for  $i \neq j$ ) and applying the OLS estimator:

$$\ln X_{ij,t} = \pi_{i,t} + \chi_{j,t} + \mathbf{GRAVITY} \times \beta + \beta_5 RTA_{ij,t} + \beta_6 WTO_{i,t} + \varepsilon_{ij,t}$$

where the vector **GRAVITY** includes the log of the distance and dummy variables for contiguity, common language, and colonial ties.

*Hints: regress*

- Re-estimate the same specification expressed in multiplicative form with the PPML estimator. Compare the results and comment.

*Hints: ppml*

(iii) Gravity estimation accounting for *intra-national* trade and potential endogeneity

- Generate pair fixed effects.
- Re-estimate the specification presented above with the PPML estimator but this time by considering *international* and *intra-national* trade. Compare the results and comment.
- In order to correct for potential endogeneity of the RTAs variable, estimate the following gravity specification with the PPML estimator:

$$X_{ij,t} = \exp\left[\pi_{i,t} + \chi_{j,t} + \mu_{ij} + \beta_5 RTA_{ij,t} + \beta_6 WTO_{i,t}\right] \times \varepsilon_{ij,t}$$

(iv) Gravity estimation accounting for globalization

- Generate international border dummies for the years 1986, 1990, 1994, 1998 and 2002.
- Estimate with the PPML estimator the following structural gravity specification:

$$X_{ij,t} = \exp\left[\pi_{i,t} + \chi_{j,t} + \mu_{ij} + \beta_5 RTA_{ij,t} + \beta_6 WTO_{i,t} + \sum_{T=1986}^{2002} \beta_T INTL\_BRDR\_T_{ij,t}\right] \times \varepsilon_{ij,t}$$

Compare the results and comment.

## 2. Estimating the effects of unilateral trade policy

The aim of this exercise is to demonstrate that the gravity model can be used to estimate the effects of non-discriminatory (across trading partners) trade policies, such as MFN tariffs. The exercise follows the approach developed by Heid et al. (2015). The STATA do-file “UnilateralTradePolicy.do” providing the solution to the exercise can be found in “Chapter1\Exercises\”.

- (i) Preliminaries
- Open the data file “Chapter1Exercise2.dta”.
  - Determine for how many countries and years data on MFN tariffs are available.  
*Hints: keep, duplicates*

- (ii) Benchmark gravity estimation
- Generate exporter-time, importer-time and pair fixed effects.  
*Hints: generate*
  - Estimate with the PPML estimator the following structural gravity specification:

$$X_{j,t} = \exp \left[ \pi_{i,t} + \chi_{j,t} + \mu_{ij} + \sum_{T=1}^4 \beta_T RTA_{j,t-3 \times (T-1)} \right] \times \varepsilon_{j,t}$$

*Hints: ppml*

- Compute the total effects of the RTAs and comment.  
*Hints: lincom*

- (iii) Gravity estimation with unilateral trade policy
- Create the logarithm of the MFN tariffs variable ( $\ln\_MFN$ ), and replace the missing values to be equal to zero.
  - Estimate with the PPML estimator the following structural gravity specification and compare the results:

$$X_{j,t} = \exp \left[ \pi_{i,t} + \chi_{j,t} + \mu_{ij} + \sum_{T=1}^4 \beta_T RTA_{j,t-3 \times (T-1)} + \beta_5 \ln\_MFN_{j,t} \times INTL_{ij} \right] \times \varepsilon_{j,t}$$

- Compute the total effects of the RTAs, compare the result and comment.
- Compute the trade elasticity of substitution based on the estimates obtained in 3.b. Discuss the result, noting that the elasticity estimates from the related trade literature usually vary between 2 and 12 (Eaton and Kortum, 2002; Anderson and van Wincoop, 2003; Broda et al., 2006).

## Appendices

### Appendix A: Structural gravity from supply side

In Section B.1, the structural gravity framework was derived from the demand side assuming an Armington (1969) setting with CES preferences. This appendix demonstrates that an isomorphic structural gravity framework can be derived from the supply side. The reader may refer to Anderson (2011) for a discussion of demand-side and supply-side gravity foundations. This derivation is based on the most influential supply-side model, the Ricardian model of international trade by Eaton and Kortum (2002).<sup>29</sup>

Consumer preferences are still assumed to be homothetic, globally common/identical across countries, and approximated by a Constant Elasticity of Substitution (CES) utility function:

$$U_j = \left[ \int_0^1 c(l)^{\frac{\sigma-1}{\sigma}} dl \right]^{\frac{\sigma}{\sigma-1}} \quad (1.A.1)$$

where  $j$  denotes the country and  $\sigma$  is the elasticity of substitution among different varieties.

Following Eaton and Kortum (2002), there is a continuum of goods  $l \in [0, 1]$ , with consumption of individual goods denoted by  $c(l)$ . In addition, trade of goods from country  $i$  to country  $j$  imposes iceberg trade costs  $t_{ij} > 1$ . In contrast to the baseline framework, countries now differ in the efficiency with which they can produce goods. Let  $z_i(l)$  denote country  $i$ 's efficiency in producing good  $l \in [0, 1]$ . Then, with constant returns to scale the cost of producing a unit of good  $l$  in country  $i$  is  $\varsigma_i/z_i(l)$ , with  $\varsigma_i$  denoting the input costs in country  $i$ . Taking iceberg trade costs into account, delivering a unit of good  $l$  produced in country  $i$  to country  $j$  costs:

$$p_{ij}(l) = \left( \frac{\varsigma_i}{z_i(l)} \right) t_{ij} \quad (1.A.2)$$

With perfect competition,  $p_{ij}(l)$  is the price consumers in country  $j$  would pay if they decide to buy good  $l$  from country  $i$ . In the presence of international trade, consumers are free to choose from which country to buy a good. Therefore, the actual price consumers pay for good  $l$  is  $p_j(l)$ , the lowest price across all sources  $i$ :

$$p_j(l) = \min \{ p_{ij}(l); i=1, \dots, N \} \quad (1.A.3)$$

where  $N$  again denotes the number of countries in the world.

Following Eaton and Kortum (2002), the country's efficiency is drawn from a Fréchet distribution:  $F_i(z) = e^{-T_i z^{-\theta}}$ , where  $T_i$  is the location parameter for country  $i$  and  $\theta$  governs the variation within the distribution, which is assumed to be common to all countries. Replacing  $z$  in  $F_i(z)$  using Equation (1.A.2) leads to  $G_j(p) = Pr[P_{ij} \leq p] = 1 - e^{-[T_i(\varsigma_i t_{ij})^{-\theta}] p^\theta}$ . Given that the distribution of prices for which a country  $j$  buys is given by  $G_j(p) = Pr[P_j \leq p] = 1 - \prod_{i=1}^N [1 - G_j(p)]$ , it simplifies to:

$$G_j(p) = 1 - e^{-\Phi_j p^\theta} \quad (1.A.4)$$

where  $\Phi_j = \sum_{i=1}^N T_i (\varsigma_i t_{ij})^{-\theta}$ .

The probability that country  $i$  provides good  $l$  at the lowest price to country  $j$  is given by:

$$\pi_{ij} = \frac{T_i(\zeta_i t_{ij})^{-\theta}}{\Phi_j} \quad (1.A.5)$$

Under the assumption of a continuum of goods between zero and one, this is also the fraction of goods that country  $j$  buys from country  $i$ . The price of a good that country  $j$  actually buys from any country  $i$  is also distributed  $G_j(p)$ , and the exact price index is given by  $P_j = \gamma \Phi_j^{-1/\theta}$  with  $\gamma = [\Gamma((\theta + 1 - \sigma)/\theta)]^{1/(1-\sigma)}$  where  $\Gamma$  is the Gamma function.

The fraction of goods that country  $j$  buys from country  $i$ ,  $\pi_{ij}$ , is also the fraction of its expenditures on goods from country  $i$ ,  $X_{ij}$ , due to the fact that the average expenditures per good do not vary by source, namely:

$$X_{ij} = \frac{T_i(\zeta_i t_{ij})^{-\theta}}{\Phi_j} E_j = \frac{T_i(\zeta_i t_{ij})^{-\theta}}{\sum_{k=1}^N T_k(\zeta_k t_{kj})^{-\theta}} E_j \quad (1.A.6)$$

where  $E_j$  is country  $j$ 's total spending.

In addition, at delivered prices (because part of the shipments melt en route), the value of output in country  $i$ ,  $Y_i$ , should be equal to the total expenditure on this country's variety in all countries in the world, including  $i$  itself:

$$Y_i = \sum_{j=1}^N X_{ij} = T_i \zeta_i^{-\theta} \sum_{j=1}^N \frac{t_{ij}^{-\theta}}{\Phi_j} E_j \quad (1.A.7)$$

Solving for  $T_i \zeta_i^{-\theta}$  in equation (1.A.7) yields:

$$T_i \zeta_i^{-\theta} = \frac{Y_i}{\sum_{j=1}^N \frac{t_{ij}^{-\theta}}{\Phi_j} E_j} \quad (1.A.8)$$

Substituting this expression for  $T_i \zeta_i^{-\theta}$  in equation (1.A.6) leads to:

$$X_{ij} = \frac{t_{ij}^{-\theta}}{\Phi_j \left( \sum_{k=1}^N \frac{t_{kj}^{-\theta}}{\Phi_k} E_k \right)} Y_i E_j \quad (1.A.9)$$

Replacing  $\Phi_j$  using  $P_j = \gamma \Phi_j^{-1/\theta}$  in both terms of the denominator of equation (1.A.9) yields:

$$X_{ij} = \frac{t_{ij}^{-\theta}}{\gamma^\theta P_j^{-\theta} \left( \sum_{k=1}^N \frac{t_{kj}^{-\theta}}{\gamma^\theta P_k^{-\theta}} E_k \right)} Y_i E_j \quad (1.A.10)$$

The term  $\Pi_i$  can be defined:

$$\Pi_i = \left( \sum_{j=1}^N \left( \frac{t_{ij}}{P_j} \right)^{-\theta} \frac{E_j}{Y} \right)^{-\frac{1}{\theta}} \quad (1.A.11)$$

where  $Y \equiv \sum_j Y_j$ .

Similarly,  $P_j$  can also be expressed as follows:

$$P_j = \left( \gamma^{-\theta} \Phi_j \right)^{-\frac{1}{\theta}} = \left( \gamma^{-\theta} \sum_{i=1}^N T_i (\zeta_i t_{ij})^{-\theta} \right)^{-\frac{1}{\theta}} = \left( \gamma^{-\theta} \sum_{i=1}^N \frac{t_{ij}^{-\theta} Y_i}{\sum_{i=1}^N \frac{t_{ij}^{-\theta}}{\Phi_i} E_i} \right)^{-\frac{1}{\theta}} = \left( \sum_{i=1}^N \left( \frac{t_{ij}}{\Pi_i} \right)^{-\theta} \frac{Y_i}{Y} \right)^{-\frac{1}{\theta}} \quad (1.A.12)$$

Equation (1.A.10) can thus be rewritten as:

$$X_{ij} = \frac{Y_i E_j}{Y} \left( \frac{t_{ij}}{\Pi_i P_j} \right)^{-\theta} \quad (1.A.13)$$

By replacing  $-\theta$  by  $1-\sigma$ , the system of equations (1.A.11)-(1.A.13) corresponds to the same exact system of equations (1-8)-(1-10) derived from the demand side in Section B.1:

	<b>Demand-side</b>	<b>Supply side</b>	
(1-8)	$X_{ij} = \frac{Y_i E_j}{Y} \left( \frac{t_{ij}}{\Pi_i P_j} \right)^{1-\sigma}$	$X_{ij} = \frac{Y_i E_j}{Y} \left( \frac{t_{ij}}{\Pi_i P_j} \right)^{-\theta}$	(1.A.13)
(1-9)	$\Pi_i^{1-\sigma} = \sum_j \left( \frac{t_{ij}}{P_j} \right)^{1-\sigma} \frac{E_j}{Y}$	$\Pi_i^{-\theta} = \sum_j \left( \frac{t_{ij}}{P_j} \right)^{-\theta} \frac{E_j}{Y}$	(1.A.11)
(1-10)	$P_j^{1-\sigma} = \sum_i \left( \frac{t_{ij}}{\Pi_i} \right)^{1-\sigma} \frac{Y_i}{Y}$	$P_j^{-\theta} = \sum_i \left( \frac{t_{ij}}{\Pi_i} \right)^{-\theta} \frac{Y_i}{Y}$	(1.A.12)

Hence, the structural gravity system can be derived from the demand and the supply side. They are *isomorphic*. The only difference is that the elasticity of substitution is replaced by the Fréchet parameter governing the variation within the distribution.

## Appendix B: Structural gravity with tariffs

This appendix extends the standard gravity model to accommodate tariffs and tariff revenues. See for a similar derivation Heid and Larch (2016), and for an application of such a framework to quantify tariff evasion Egger and Larch (2012). All main assumptions are preserved. Specifically, each of the  $N$  countries in the world produces a differentiated variety of goods (Armington, 1969). The supply of each variety is fixed at  $Q_i$  with a corresponding factory-gate price  $p_i$ . Thus, the value of (income from) domestic production in country  $i$  is defined as  $Y_i = p_i Q_i$ . Consumer preferences are approximated by a Constant Elasticity of Substitution (CES) utility function defined as:

$$\left\{ \sum_i \alpha_i^{\frac{1-\sigma}{\sigma}} c_{ij}^{\frac{\sigma-1}{\sigma}} \right\}^{\frac{\sigma}{\sigma-1}} \quad (1.B.1)$$

where  $\sigma > 1$  is the trade elasticity of substitution;  $\alpha_i > 0$  is the CES preference parameter; and  $c_{ij}$  denotes consumption of varieties from country  $i$  in country  $j$ . Consumers maximize (1.B.1) subject to the following budget constraint:

$$E_j = \sum_i p_{ij} c_{ij} = Y_j + \sum_i (\tau_{ij} - 1) X_{ij} \quad (1.B.2)$$

Budget constraint (1.B.2) is adjusted to reflect the fact that tariff revenues,  $\sum_i (\tau_{ij} - 1) X_{ij}$ , are collected, and that these revenues are assumed to be fully rebated to consumers and add to their nominal income from production  $Y_j$ .<sup>30</sup> Tariffs here are defined as  $\tau_{ij} = 1 + \text{adv\_tariff}_{ij}$  where  $\text{adv\_tariff}_{ij}$  is the ad-valorem tariff on varieties imported in country  $j$  from country  $i$ . Finally, equation (1.B.2) ensures that the total expenditure in country  $j$  is equal to the total spending on varieties from all countries, including  $j$ , at delivered prices  $p_{ij} = \tau_{ij} p_i t_{ij}$ , which now are defined as a function of tariffs,  $\tau_{ij}$ , in addition to factory-gate prices in the origin,  $p_i$ , and the iceberg costs,  $t_{ij} \geq 1$ .

Solving the consumer's optimization problem yields the Marshallian consumer demand for goods shipped from origin  $i$  to destination  $j$ , which reads as follows:

$$c_{ij} = p_{ij}^{-\sigma} \left( \frac{\alpha_i}{P_j} \right)^{1-\sigma} E_j \quad (1.B.3)$$

where  $E_j$  corresponds to total expenditure in country  $j$  and  $P_j$  denotes the CES consumer price index defined as:

$$P_j = \left[ \sum_i (\alpha_i p_i)^{1-\sigma} \right]^{\frac{1}{1-\sigma}} \quad (1.B.4)$$

Using equation (1.B.3) the value of exports from  $i$  to  $j$  at delivered prices is defined as:

$$X_{ij} = c_{ij} p_i t_{ij} = \tau_{ij}^{-\sigma} \left( \frac{\alpha_i p_i t_{ij}}{P_j} \right)^{1-\sigma} E_j \quad (1.B.5)$$

The final step in the derivation of the structural gravity model is to impose market clearance for goods from each origin, namely:

$$Y_i = \sum_j X_{ij} = \sum_j \tau_{ij}^{-\sigma} \left( \frac{\alpha_i p_i t_{ij}}{P_j} \right)^{1-\sigma} E_j \quad (1.B.6)$$

The first equality in equation (1.B.6) specifies that the pre-tariff value of total expenditure on goods from country  $i$ ,  $\sum_j X_{ij}$ , is equal to the value of output in country  $i$ ,  $Y_i$ . The second equality in equation (1.B.6) applies the definition of bilateral expenditure from equation (1.B.5). Defining the total world output,  $Y \equiv \sum_i Y_i$ , and dividing the left and the right side of equation (1.B.6) by  $Y$  yields after rearrangement:

$$(\alpha_i p_i)^{1-\sigma} = \frac{Y_i/Y}{\sum_j \tau_{ij}^{-\sigma} \left( \frac{t_{ij}}{P_j} \right)^{1-\sigma} \frac{E_j}{Y}} \quad (1.B.7)$$

Defining the term in the denominator of equation (1.B.7) as  $\Pi_i^{1-\sigma} \equiv \sum_j \tau_{ij}^{-\sigma} \left( \frac{t_{ij}}{P_j} \right)^{1-\sigma} E_j/Y$ , and substituting this definition into equation (1.B.7) simplifies the expression as follows:

$$(\alpha_i p_i)^{1-\sigma} = \frac{Y_i/Y}{\Pi_i^{1-\sigma}} \quad (1.B.8)$$

Using equation (1.B.8) to substitute for the power transform  $(\alpha_i p_i)^{1-\sigma}$  in the bilateral allocations equation (1.B.5) and in the CES price index equation (1.B.4), and combining the definition of  $\Pi_i^{1-\sigma}$  with the resulting expressions that correspond to equation (1.B.5) and equation (1.B.6), the structural gravity system with tariffs is defined as:

$$X_{ij} = \frac{Y_i E_j}{Y} \left( \frac{t_{ij}}{\Pi_i P_j} \right)^{1-\sigma} \tau_{ij}^{-\sigma} \quad (1.B.9)$$

$$\Pi_i^{1-\sigma} = \sum_j \tau_{ij}^{-\sigma} \left( \frac{t_{ij}}{P_j} \right)^{1-\sigma} \frac{E_j}{Y} \quad (1.B.10)$$

$$P_j^{1-\sigma} = \sum_i \left( \frac{t_{ij} \tau_{ij}}{\Pi_i} \right)^{1-\sigma} \frac{Y_i}{Y} \quad (1.B.11)$$

The system of equations (1.B.9)-(1.B.11) resembles the system of equations (1-8)-(1-10) defined in Section B.1. However, there are two differences, which have implications for the estimation of gravity and for the welfare analysis with the gravity model. These differences are:

- (i) Tariffs enter the gravity equation (1.B.9) directly and indirectly, via the multilateral resistances. The implication with respect to gravity estimations is that tariffs will appear in the estimating equation and, more importantly, the estimate of the coefficient on tariffs can be used to directly



recover a value for the trade elasticity parameter. In addition, the structural gravity theory presented here can be used to calculate tariff equivalent effects for each of the gravity covariates. The interested reader may refer to Larch and Wanner (2014) for further discussion and analysis of the empirical implications of the inclusion of tariffs.

- (ii) The expression for expenditure differs from the value of total production owing to tariff revenues. This difference has no implications for gravity estimations since expenditure at the country level, regardless of their functional form, will be absorbed by the *importer-time* fixed effects. However, this difference has important implications for welfare analysis. Specifically, as demonstrated by Anderson and van Wincoop (2001), the expression for real income with rents from tariff becomes:

$$\tilde{W}_j = \frac{Q_j P_j}{P_j} \frac{1}{1 - \sum_i (\tau_{ij} - 1) s_{ij}} \quad (1.B.12)$$

where  $s_{ij} = \tau_{ij} X_{ij} / E_j = (\alpha_i p_{ij} / P_j)^{1-\sigma}$  is the CES expenditure share on goods from country  $i$  in country  $j$  (including tariffs). The first fraction in equation (1.B.12) is the expression for real income from the gravity model without tariffs. The second fraction is a tariff multiplier, which captures the additional welfare effects of the introduction of tariffs and rents. The expression for the tariff multiplier as an adjustment to nominal income can be obtained by using the definition of  $s_{ij}$  in budget constraint (1.B.2) and then solving for total expenditure. The interested reader may refer to Anderson and van Wincoop (2001) for further comparative statics and discussion of the welfare implications of the introduction of tariffs and rents.

## Appendix C: Databases and data sources links summary

<i>Data</i>	<i>Database</i>	<i>Link</i>
<b>Country-specific data</b>	IFS	<a href="http://data.imf.org/?sk=5DABAFF2-C5AD-4D27-A175-1253419C02D1">http://data.imf.org/?sk=5DABAFF2-C5AD-4D27-A175-1253419C02D1</a>
	WDIs	<a href="http://databank.worldbank.org/data/reports.aspx?source=world-development-indicators">http://databank.worldbank.org/data/reports.aspx?source=world-development-indicators</a>
<b>Aggregated merchandise trade flows</b>	PWT	<a href="http://www.rug.nl/research/ggdc/data/pwt">http://www.rug.nl/research/ggdc/data/pwt</a>
	DOTS	<a href="http://data.imf.org/?sk=9D6028D4-F14A-464C-A2F2-59B2CD424B85&amp;ss=13900303418545">http://data.imf.org/?sk=9D6028D4-F14A-464C-A2F2-59B2CD424B85&amp;ss=13900303418545</a>
	Correlates of War Project	<a href="http://correlatesofwar.org/data-sets/bilateral-trade">http://correlatesofwar.org/data-sets/bilateral-trade</a> .
<b>Disaggregated merchandise trade</b>	Comtrade	<a href="http://comtrade.un.org">http://comtrade.un.org</a>
	BACI	<a href="http://www.cepii.fr/cepii/en/bdd_modele/presentation.asp?id=1">http://www.cepii.fr/cepii/en/bdd_modele/presentation.asp?id=1</a>
	WTF	<a href="http://cid.econ.ucdavis.edu/Html/WTF_bilateral.html">http://cid.econ.ucdavis.edu/Html/WTF_bilateral.html</a>
	Trade Map	<a href="http://www.trademap.org/Index.aspx">http://www.trademap.org/Index.aspx</a>
<b>Service trade flows</b>	Global Trade Atlas	<a href="https://www.gtis.com/gta">https://www.gtis.com/gta</a>
	OECD's Trade in Services	<a href="https://stats.oecd.org/Index.aspx?DataSetCode=TISP">https://stats.oecd.org/Index.aspx?DataSetCode=TISP</a>
	UN Service Trade	<a href="http://comtrade.un.org/">http://comtrade.un.org/</a>
	Trade Map	<a href="http://www.trademap.org/Index.aspx">http://www.trademap.org/Index.aspx</a>
	Francois and Pindyuk's Trade in Service	<a href="https://ideas.repec.org/p/lnz/wpaper/20130101.html">https://ideas.repec.org/p/lnz/wpaper/20130101.html</a>
	FAOSTAT Detailed Trade Matrix	<a href="http://faostat3.fao.org/download/T/TM/E">http://faostat3.fao.org/download/T/TM/E</a>
<b>Intra-national trade flows data</b>	TPP	<a href="http://econ.worldbank.org/WBSITE/EXTERNAL/EXTDEC/EXTRESEARCH/0,,contentMDK:21085384~pagePK:64214825~piPK:64214943~theSitePK:469382,00.html">http://econ.worldbank.org/WBSITE/EXTERNAL/EXTDEC/EXTRESEARCH/0,,contentMDK:21085384~pagePK:64214825~piPK:64214943~theSitePK:469382,00.html</a>
	TradeProd	<a href="http://www.cepii.fr/CEPII/fr/bdd_modele/presentation.asp?id=5">http://www.cepii.fr/CEPII/fr/bdd_modele/presentation.asp?id=5</a>
	INDSTAT	<a href="http://stat.unido.org/">http://stat.unido.org/</a>
<b>Time-invariant covariates</b>	GeoDist	<a href="http://www.cepii.fr/cepii/en/bdd_modele/presentation.asp?id=6">http://www.cepii.fr/cepii/en/bdd_modele/presentation.asp?id=6</a>
<b>Tariff data</b>	IDB	<a href="https://tao.wto.org/welcome.aspx?ReturnUrl=%2f%3fui%3d1&amp;ui=1">https://tao.wto.org/welcome.aspx?ReturnUrl=%2f%3fui%3d1&amp;ui=1</a> or <a href="http://tariffdata.wto.org/">http://tariffdata.wto.org/</a> .
	CTS	<a href="https://tao.wto.org/welcome.aspx?ReturnUrl=%2f%3fui%3d1&amp;ui=1">https://tao.wto.org/welcome.aspx?ReturnUrl=%2f%3fui%3d1&amp;ui=1</a> or <a href="http://tariffdata.wto.org/">http://tariffdata.wto.org/</a> .
	TRAINS	<a href="http://databank.worldbank.org/data/reports.aspx?source=UNCTAD---Trade-Analysis-Information-System-(TRAINS)">http://databank.worldbank.org/data/reports.aspx?source=UNCTAD---Trade-Analysis-Information-System-(TRAINS)</a>
	MacMap	<a href="http://www.macmap.org/Default.aspx?ReturnUrl=%2fAdvancedSearch%2fTariffAndTrade%2fDefault.aspx">http://www.macmap.org/Default.aspx?ReturnUrl=%2fAdvancedSearch%2fTariffAndTrade%2fDefault.aspx</a>
<b>Various NTMs</b>	I-TIP	<a href="https://www.wto.org/english/res_e/statis_e/itip_e.htm">https://www.wto.org/english/res_e/statis_e/itip_e.htm</a>
	OECD's AMAD	<a href="https://www.oecd.org/site/amad">https://www.oecd.org/site/amad</a> .
	TPP	<a href="http://econ.worldbank.org/WBSITE/EXTERNAL/EXTDEC/EXTRESEARCH/0,,contentMDK:21085384~pagePK:64214825~piPK:64214943~theSitePK:469382,00.html">http://econ.worldbank.org/WBSITE/EXTERNAL/EXTDEC/EXTRESEARCH/0,,contentMDK:21085384~pagePK:64214825~piPK:64214943~theSitePK:469382,00.html</a>
	TRAINS	<a href="http://databank.worldbank.org/data/reports.aspx?source=UNCTAD---Trade-Analysis-Information-System-(TRAINS)">http://databank.worldbank.org/data/reports.aspx?source=UNCTAD---Trade-Analysis-Information-System-(TRAINS)</a>
	NTM-MAP	<a href="http://www.cepii.fr/CEPII/en/bdd_modele/presentation.asp?id=28">http://www.cepii.fr/CEPII/en/bdd_modele/presentation.asp?id=28</a>
	I-TIP	<a href="https://www.wto.org/english/res_e/statis_e/itip_e.htm">https://www.wto.org/english/res_e/statis_e/itip_e.htm</a>
	Trade Monitoring	<a href="http://tmdb.wto.org/searchmeasures.aspx?lang=en-US">http://tmdb.wto.org/searchmeasures.aspx?lang=en-US</a>
	Global Trade Alert	<a href="http://www.globaltradealert.org/">www.globaltradealert.org/</a>

(Continued)

(Continued)

<i>Data</i>	<i>Database</i>	<i>Link</i>
<b>Export subsidies</b>	Agricultural Information Management System	<a href="http://agims.wto.org/">http://agims.wto.org/</a>
<b>Fossil fuel subsidies</b>	IEA's data	<a href="http://www.worldenergyoutlook.org/resources/energysubsidies/fossilfuelsubsidydatabase/">http://www.worldenergyoutlook.org/resources/energysubsidies/fossilfuelsubsidydatabase/</a>
<b>Aggregated subsidies</b>	World Bank's data	<a href="http://databank.worldbank.org/data/reports.aspx?source=world-development-indicators">http://databank.worldbank.org/data/reports.aspx?source=world-development-indicators</a>
<b>Export restrictions</b>	OECD's Inventory on export restrictions	<a href="http://qdd.oecd.org/subject.aspx?Subject=ExportRestrictions_PrimaryAgriculture">http://qdd.oecd.org/subject.aspx?Subject=ExportRestrictions_PrimaryAgriculture</a> <a href="http://qdd.oecd.org/subject.aspx?Subject=ExportRestrictions_IndustrialRawMaterials">http://qdd.oecd.org/subject.aspx?Subject=ExportRestrictions_IndustrialRawMaterials</a>
<b>Trade remedies</b>	TTBD	<a href="http://econ.worldbank.org/WBSITE/EXTERNAL/EXTDEC/EXTRESEARCH/EXTPROGRAMS/EXTTRADERESEARHC/0,,contentMDK:22561572~pagePK:64168182~piPK:64168060~theSitePK:544849,00.html">http://econ.worldbank.org/WBSITE/EXTERNAL/EXTDEC/EXTRESEARCH/EXTPROGRAMS/EXTTRADERESEARHC/0,,contentMDK:22561572~pagePK:64168182~piPK:64168060~theSitePK:544849,00.html</a>
<b>Technical barriers to trade (TBT)</b>	TBT-IMS	<a href="http://tbtims.wto.org/">http://tbtims.wto.org/</a>
<b>Sanitary and phytosanitary measures (SPS)</b>	SPS-IMS	<a href="http://spsims.wto.org/">http://spsims.wto.org/</a>
<b>TBT and SPS</b>	Perinorm	<a href="http://www.perinorm.com/home/default.aspx?ReturnUrl=%2fdefault.aspx">http://www.perinorm.com/home/default.aspx?ReturnUrl=%2fdefault.aspx</a>
<b>Service trade restrictiveness index (STRI)</b>	OECD's STRI World Bank's STRI Service I-TIP	<a href="http://qdd.oecd.org/subject.aspx?Subject=063bee63-475f-427c-8b50-c19bffa7392d">http://qdd.oecd.org/subject.aspx?Subject=063bee63-475f-427c-8b50-c19bffa7392d</a> <a href="http://iresearch.worldbank.org/servicetrade/">http://iresearch.worldbank.org/servicetrade/</a> <a href="http://i-tip.wto.org/services/default.aspx">http://i-tip.wto.org/services/default.aspx</a>
<b>Trade facilitation</b>	Doing Business OECD's TFI LPI ETI	<a href="http://databank.worldbank.org/data/reports.aspx?source=doing-business">http://databank.worldbank.org/data/reports.aspx?source=doing-business</a> <a href="http://www.oecd.org/trade/facilitation/indicators.htm">http://www.oecd.org/trade/facilitation/indicators.htm</a> <a href="http://lpi.worldbank.org/">http://lpi.worldbank.org/</a> <a href="https://knoema.com/atlas/sources/WEF?topic=Foreign-Trade">https://knoema.com/atlas/sources/WEF?topic=Foreign-Trade</a>
<b>Preferential and regional trade agreements</b>	RTA-IS Larch's RTA Bergstrand's EIA WTO's PTA GTPA DESTA	<a href="http://rtais.wto.org/UI/PublicMaintainRTAHome.aspx">http://rtais.wto.org/UI/PublicMaintainRTAHome.aspx</a> <a href="http://www.ewf.uni-bayreuth.de/en/research/RTA-data/index.html">http://www.ewf.uni-bayreuth.de/en/research/RTA-data/index.html</a> <a href="http://kellogg.nd.edu/faculty/fellows/bergstrand.shtml">http://kellogg.nd.edu/faculty/fellows/bergstrand.shtml</a> <a href="http://ptadb.wto.org/?lang=1">http://ptadb.wto.org/?lang=1</a> <a href="http://wits.worldbank.org/gptad/database_landing.aspx">http://wits.worldbank.org/gptad/database_landing.aspx</a> <a href="http://www.designoftradeagreements.org/www.designoftradeagreements.org/indexf908.html?page_id=884">http://www.designoftradeagreements.org/www.designoftradeagreements.org/indexf908.html?page_id=884</a>

## Endnotes

- 1 This chapter is based on the paper "Estimating Trade Policy Effects with Structural Gravity" prepared by Piermartini and Yotov (2016).
- 2 The CES utility function assumption is widely used in the existing gravity literature. Anderson and Neary (2005) discuss the implications of more general, non-homothetic preferences. Recent attempts to depart from CES utility function, while preserving the key properties of the structural gravity model, include Novy (2013), Behrens et al. (2014), and Arkolakis et al. (2015), who also provide an informative review of the main alternatives to CES utility functions that have been used in the trade literature.
- 3 See for a derivation of the CES demand equation Appendix 2.A in Baldwin et al. (2011).
- 4 World output,  $Y$ , does not appear explicitly in the general discussions of the structural gravity model as presented in some recent surveys and academic articles that adjust the definitions of equations (1-8), (1-9) and (1-10) to account for  $Y$ .
- 5 Anderson (2011) offers an insightful discussion and formal proofs of these and other, less obvious, properties based on the relationship between trade flows and country size in a frictionless world.
- 6 In principle, the interpretation problem can be fixed by using the inverse hyperbolic sine function (Kristjánssdóttir, 2012). However, this procedure has to be applied with caution because it is a non-linear transformation (as is the log-transformation), which means that with heteroskedastic trade data one may end up with inconsistent estimates (Santos Silva and Tenreyro, 2006).
- 7 For a discussion of the relative merits of the PPML estimator vs. other linear and non-linear estimators, the interested reader may refer to Santos Silva and Tenreyro (2006), Santos Silva and Tenreyro (2011), Egger and Staub (2016), and Head and Mayer (2014).
- 8 In principle, the heteroscedasticity issue can be addressed with other estimators, such as the Gamma estimator.
- 9 The reader may refer to Disdier and Head (2008) and Head and Mayer (2013) for an analysis of the use and impact of distance in gravity regressions.
- 10 See for example Magee (2003) and Baier and Bergstrand (2002, 2004). Egger et al. (2011) offer a recent IV treatment of the endogeneity of trade agreements in a cross-section setting.
- 11 Monte Carlo simulations suggest that although the PPML estimator underestimates the distance effect, the estimates of the parameter associated with the distance variable converges to the true value as the sample size increases (Head and Mayer, 2014). The interested reader may refer to the "Log of Gravity" webpage at <http://personal.lse.ac.uk/tenreyro/LGW.html> for a series of discussions on the benefits and potential downside of using the PPML estimator.
- 12 If the trade policy is a barrier, for example a dummy for a quota, the formula for calculating the ad-valorem tariff equivalent whose removal would have generated the same impact as the removal of the barrier in question would be  $e^{\beta_{QUOTA}/(\beta_{TARIFF}-1)} \times 100$ .
- 13 The interested reader may refer to Felbermayr et al. (2015) for a discussion of the sensitivity of the results in counterfactual gravity analysis to the choice of the elasticity of substitution.
- 14 The OECD and WTO are currently working on building a global matrix of trade in services statistics. The dataset will include exports and imports of total services and of 11 main EBOPS 2002 items, and will cover 191 reporters and partners for the period 1995-2012. Data are obtained from OECD, Eurostat, WTO-UNCTAD-ITC and national sources. Missing observations are estimated using different techniques, such as backcasting, forecasting, interpolations, derivations, integration of EBOPS 2010 data, as well as gravity-model based estimates in order to obtain a complete, square matrix. An EBOPS 2010 version of the dataset is also envisaged for the near future.
- 15 Under the Project to Improve Provincial Economic Statistics (PIPES), Canada's government has created a database that includes consistent intra-national and international data for Canada's economy at the sectoral level for the period 1997-2007. See Genereux and Langen (2002) for further details.
- 16 The CEPII's CHELEM-International Trade database covers 94 countries from 1967 onwards with sectoral data classified according to the CHELEM nomenclature (71 sectors), GTAP (43 sectors) and ISIC classification (147 sectors). The CHELEM nomenclature has been built to allow a better correspondence between data on trade and production. However, unlike the first three databases, the CHELEM-International Trade database includes estimated observations, and therefore should not be used for gravity estimations.

- 17 Bound rates are in general neglected in standard specifications of gravity models, as bound rates only reflect countries commitments but are not the tariffs that importers and exporters face when trading. Recent economic literature has, however, highlighted the importance that bound rates can have in determining a firm's decision to trade insofar as they affect the certainty of trading conditions (Handley and Limão, 2013; Handley, 2014; Osnago et al., 2015). A direct measure of trade policy uncertainty is the so-called "tariff water"—the gap between the bound and applied tariff rate.
- 18 As the data used for the applications is a panel data set with repeated observations of pairs of countries over time, common observable and unobservable effects may naturally arise. While important bilateral time-varying effects are controlled for with explanatory variables, such as RTAs, and any bilateral time-invariant effects are taken into account with fixed effects, some correlation pattern between pairs of countries over time may still be present in the error term. This correlation pattern is captured by clustering the errors over country-pairs. Bertrand et al. (2004) provide some evidence that this general procedure does quite well.
- 19 The dimensions of the data were predetermined by the availability of consistently constructed *international* and *intra-national* trade flows data. The sample covers the following countries: Argentina, Australia, Austria, Belgium-Luxembourg, Bolivia, Brazil, Bulgaria, Cameroon, Canada, Chile, China, Colombia, Costa Rica, Cyprus, Denmark, Ecuador, Egypt, Finland, France, Germany, Greece, Hong Kong (China), Hungary, Iceland, India, Indonesia, Iran, Ireland, Israel, Italy, Japan, Jordan, Kenya, Kuwait, Macao (China), Malaysia, Malta, Mauritius, Malawi, Mexico, Morocco, Myanmar, the Netherlands, Nepal, Niger, Nigeria, Norway, Panama, the Philippines, Poland, Portugal, Qatar, Romania, Senegal, Singapore, South Africa, the Republic of Korea, Spain, Sri Lanka, Sweden, Switzerland, Tanzania, Thailand, Trinidad and Tobago, Tunisia, Turkey, Uruguay, the United Kingdom, and the United States.
- 20 The interested reader may refer to Baier et al. (2016) for further details on the construction of the trade data.
- 21 The interested reader may refer to Melitz (2008) and Melitz and Toubal (2014) for recent and more involved analysis of the effects of language on international trade.
- 22 For expositional simplicity, the notation used for the coefficients and error term is the same when moving from specification (1-23) to specification (1-24), although technically speaking it should be different.
- 23 The Ramsey RESET test detects whether potential variables are omitted in the model specification. The null hypothesis ( $H_0$ ) states that the model does not suffer from misspecification errors suggesting the model is correctly specified. The null hypothesis can be rejected when the  $p$ -value is smaller than the critical value. Conversely, the null hypothesis cannot be rejected if the  $p$ -value is larger than the significance value.
- 24 The distance puzzle has been of significant interest to the professions. See for example Buch et al. (2004), Carrère and Schiff (2005), Brun et al. (2005), Boulhol and de Serres (2010), Lin and Sim (2012), and Larch et al. (2016).
- 25 Some recent studies obtain region-specific estimates of the variable *SMCTRY* and document wide variation of those estimates across countries (Anderson et al., 2016b) and even across provinces within Canada (Agnosteva et al., 2014). Related studies investigate the implications of intra-national trade costs for international trade and welfare (Ramondo et al., 2014).
- 26 While this application focuses on the effects of regional trade agreements, a different literature investigates the questions about which countries (Baier and Bergstrand, 2004; Egger and Larch, 2008) and when (Bergstrand et al., 2016) regional trade agreements are concluded.
- 27 When individual, country-specific fixed effects are used instead of a single *SMCTRY* indicator variable, all country-specific dummies for intra-national trade have to be dropped. This will have no effect on the estimates from column (4) of Table 3.
- 28 Felbermayr et al. (2015, pp. 7) explain the downward bias as follows: "If the error term in the gravity model represents unobservable policy-related barriers that reduce trade, and if those barriers make an RTA more likely, then the RTA dummy and the error term will be negatively correlated, leading to underestimation of the RTA coefficient."
- 29 The reader may refer to Heid and Larch (2016) for a similar derivation.
- 30 For the ease of notation, trade imbalances are not considered in this appendix. See for a derivation of a model with tariffs and trade imbalances for example Online Appendix A of Heid and Larch (2016).

# CHAPTER 2: General equilibrium trade policy analysis with structural gravity<sup>1</sup>

---

## TABLE OF CONTENTS

A. Overview and learning objectives	69
B. Analytical tools	70
1. Structural gravity: general equilibrium context	70
2. Standard approach to general equilibrium analysis with structural gravity	88
3. A general equilibrium gravity analysis with the Poisson Pseudo Maximum Likelihood (GEPPML)	95
C. Applications	102
1. Trade without borders	103
2. Impact of regional trade agreements	111
D. Exercises	117
1. Calculating the general equilibrium impacts of removing a specific border	117
2. Calculating the general equilibrium impacts of a regional trade agreement	118
Appendices	119
Appendix A: Counterfactual analysis using supply-side gravity framework	119
Appendix B: Structural gravity with sectors	121
Appendix C: Structural gravity system in changes	126
Endnotes	128

## LIST OF FIGURES

Figure 2	Partial equilibrium	75
Figure 3	Conditional general equilibrium	76
Figure 4	Full endowment general equilibrium	79
Figure 5	General equilibrium PPML iterative procedure	100
Figure 6	Effects of abolishing international borders on exports	110
Figure 7	Effects of abolishing international borders on real GDP	110

## LIST OF TABLES

Table 4	General equilibrium effects of NAFTA	116
---------	--------------------------------------	-----

## LIST OF BOXES

Box 3	Bilateral trade costs with missing trade flow data	97
-------	--	----

## A. Overview and learning objectives

A general equilibrium analysis accounts for all the direct and indirect linkages between the various elements in the economic system considered (e.g. countries or sectors), while imposing and satisfying all goods/services market-clearing and resource market-clearing conditions.

Due to the nature of international trade and the significant interdependence between the various economic entities in the world trade system, trade policy analysis is standardly performed in a general equilibrium setting. However, doing competent general equilibrium analysis is not a trivial task. The objective of this chapter is to serve as a practical guide for obtaining the general equilibrium effects of trade policies (and other determinants of bilateral trade) with the structural gravity model.

Although this chapter gives credit to a large number of related studies and offers general implications and analysis whenever possible, it is not intended to be a survey of the related contemporary literature, neither is it intended to be a review of the wide literature devoted to applied and computable general equilibrium (CGE) analysis. That being said, and as explained in Chapter 1, although this *Advanced Guide* focuses on the original Armington-Constant Elasticity of Substitution (CES) gravity model, many of the recommendations made here are quite general and apply to a wider range of trade models that, as demonstrated earlier, all converge to the same structural gravity system, subject to parameter interpretation. In combination with the theory-consistent estimation recommendations formulated in Chapter 1, the tractable structural gravity theory and the novel empirical developments presented in this chapter will help applied economists and practitioners to overcome the challenges to general equilibrium modelling and enable them to perform rigorous evaluation of the general equilibrium effects of various trade policies.

The first part of this chapter will provide a deep analysis of the structural interpretations of the relationships underlying the general equilibrium gravity system, and how they can be exploited to make trade policy inferences. The section also demonstrates how gravity can be integrated with a broader class of general equilibrium models by nesting the structural gravity model within a dynamic production superstructure with capital accumulation. A series of theory-consistent indexes that can be used to summarize, decompose, and aggregate the general equilibrium effects of trade policy will be presented and discussed. Next, the standard procedure to perform general equilibrium counterfactual analysis with the structural gravity model is reviewed. Drawing from recent developments in the empirical gravity literature, which capitalize on the properties of the Poisson Pseudo Maximum Likelihood (PPML) estimator, a simple procedure that can be used to obtain theory-consistent general equilibrium effects of trade policy with the structural gravity model, directly in standard software packages (e.g. STATA software), will be presented. Key elements of the STATA codes needed to obtain the results from the applications are included in the main text, while the complete STATA codes can be downloaded from the *Practical Guide's* website.

The second part of the chapter complements the theoretical developments presented previously with two counterfactual experiments. The first application simulates the removal of existing international borders in the world, while the second counterfactual experiment considers the general equilibrium effects of the North American Free Trade Agreement (NAFTA).

Two exercises are available at the end of the chapter. Data and STATA do-files for the solution of these exercises can be downloaded from the website.



In this chapter, you will learn:

- How to perform general equilibrium counterfactual analysis of trade policy with the structural gravity model;
- How to obtain theory-consistent general equilibrium effects of trade policy with the structural gravity model by capitalizing on the property of the PPML estimator;
- How to construct theory-consistent indexes to aggregate and decompose the general equilibrium effects of trade policy;
- How the structural gravity model can be integrated with a broader class of general equilibrium models;
- How to interpret general equilibrium results to make trade policy inferences.

After reading this chapter, with sound econometric knowledge, and familiarity with STATA, you will be able to perform general equilibrium counterfactual analysis of trade policy directly using STATA, and construct a series of general equilibrium trade cost indexes and their responses to trade policy changes.

## B. Analytical tools

### 1. Structural gravity: general equilibrium context

As reviewed in detail in part B.1 of Chapter 1, and as demonstrated in the Appendices 1.A, 1.B, and 2.B, subject to interpretation of the structural parameters, the following structural gravity system of trade can be derived from many underlying theoretical foundations:

$$X_{ij} = \frac{Y_i E_j}{Y} \left( \frac{t_{ij}}{\Pi_i P_j} \right)^{1-\sigma} \quad (2-1)$$

$$\Pi_i^{1-\sigma} = \sum_j \left( \frac{t_{ij}}{P_j} \right)^{1-\sigma} \frac{E_j}{Y} \quad (2-2)$$

$$P_j^{1-\sigma} = \sum_i \left( \frac{t_{ij}}{\Pi_i} \right)^{1-\sigma} \frac{Y_i}{Y} \quad (2-3)$$

$$p_i = \left( \frac{Y_i}{Y} \right)^{\frac{1}{1-\sigma}} \frac{1}{\alpha_i \Pi_i} \quad (2-4)$$

$$E_i = \varphi_i Y_i = \varphi_i p_i Q_i \quad (2-5)$$

where:  $X_{ij}$  denotes nominal trade flows from exporter  $i$  to destination  $j$ ;  $E_j$  is the total expenditure in importer  $j$ ;  $Y_i$  is the value of total production in exporter  $i$ ;  $Y$  is the value of world output;  $t_{ij}$  denotes bilateral trade frictions between partners  $i$  and  $j$ ;  $\sigma > 1$  is the elasticity of substitution among goods from different countries;  $\alpha_i$  is the CES preference parameter;  $P_j$  and  $\Pi_i$  are structural terms defined by Anderson and van Wincoop (2003) as the inward and outward multilateral resistances, respectively;  $p_i$  is the factory-gate price for each variety of goods in the country of origin  $i$ ;  $Q_i$  is the endowment or quantity supplied of each variety of goods in country  $i$ ; and  $\phi_i$  is an exogenous parameter defining the relation between the value of output and aggregate expenditure, such that when  $\phi_i > 1$ , country  $i$  faces a trade deficit, while country  $i$  runs a trade surplus when  $1 > \phi_i > 0$ .

This section starts with a discussion on six appealing properties of the multilateral resistances as the key vehicles to translate the partial equilibrium changes in trade costs into general equilibrium trade policy effects. Next, the effects of hypothetical bilateral trade liberalization scenarios are discussed, demonstrating how a bilateral trade liberalization shock is transmitted via the multilateral resistances throughout the whole economic system. The section concludes with a presentation of several useful general equilibrium indexes that summarize the effects of trade policy and decompose their incidence on producers and consumers in the world.

### (a) Properties of the multilateral resistances

Coined by Anderson and van Wincoop (2003) as the multilateral resistances, the terms of the structural gravity systems,  $\Pi_i$ , the outward multilateral resistance (OMR) and  $P_j$ , the inward multilateral resistance (IMR) are at the heart of the general equilibrium analysis of trade policy presented in this *Advanced Guide*. In that context, the multilateral resistance terms feature six main (and interrelated) properties.

#### 1. *The multilateral resistances are intuitive structural trade cost terms*

The multilateral resistances bear the intuitive interpretation that, all else equal, two countries will trade more with each other the more remote they are from the rest of the world. Proper account for the multilateral resistances is the key difference between the naive vs. theory-founded applications of the trade gravity model (Anderson and van Wincoop, 2003). While the multilateral resistances developed by Anderson and van Wincoop (2003) offer an elegant structure behind remoteness, Krugman (1995) offers a great intuition for remoteness by comparing the hypothetical levels of trade between two economies that are always at the same distance from each other but once they are on Mars and once they are in the middle of Europe. As discussed in section B.2. of Chapter 1, several researchers have proposed to construct proxies for the multilaterals resistances, often referred to as “remoteness indexes”, such as GDP-weighted distance averages. Although easy to construct, such a-theoretical remoteness indexes are not perfectly consistent with the general equilibrium analysis presented here. This is one of the reasons why, as discussed in Chapter 1, Head and Mayer (2014) advise against their use.

#### 2. *The multilateral resistances are theory-consistent aggregates of bilateral trade costs*

As is evident from the definitions of the multilateral terms from equations (2-2) and (2-3), the multilateral resistances are theory-consistent aggregates of all possible bilateral trade costs to the

country level. In combination with the other properties of the multilateral resistances, this property is very convenient and important for computational and interpretation purposes because, by construction, the multilateral resistance terms can be used to collapse the  $N \times N$ -dimensional system of bilateral links in the gravity model into a  $2 \times N$ -dimensional series of country-specific indexes.

### 3. *The multilateral resistances are general equilibrium trade cost indexes*

Of utmost importance for the purpose of this chapter, the multilateral resistances are general equilibrium trade cost terms that capture the fact that a change in bilateral trade costs between any two partners, such as the formation of a RTA, will result in (i) additional effects (in addition to the direct partial effects) for the parties to the RTA but (ii) will also affect all other countries in the world with (iii) possible feedback effects on the original liberalizing partners.

As discussed earlier, trade between two countries depends not only on the direct trade costs between these countries but also on how remote they are from the rest of their trading partners, which is captured by the multilateral resistances. Applying this intuition to the case of trade liberalization between two countries, the general equilibrium forces will translate into lower multilateral resistances for the RTA's members and into higher multilateral resistances for all other countries in the world. The intuition for this result is that when two countries become more integrated with each other, all else equal, they also become relatively more isolated from the rest of the world.

### 4. *The multilateral resistances decompose the incidence of trade costs*

The multilateral resistances decompose the aggregate incidence of trade costs and their changes on consumers and producers in each country. Equation (2-2) shows that the outward multilateral resistance term is a weighted-average aggregate of all bilateral trade costs for the producers of goods in each country. It is as if each country  $i$  shipped its product to a single world market facing supply side incidence of trade costs  $\Pi_i$ .<sup>2</sup> Similarly, equation (2-3) defines the inward multilateral resistance as a weighted average of all bilateral trade costs that fall on the consumers in each region. It is as if each country  $j$  bought its goods from a single world market facing demand side incidence of  $P_j$ . Importantly, this property in combination with the two previous ones will enable to quantify and decompose the effects of trade policy changes between any two countries into separate effects on producers and consumers in every country in the world.

### 5. *The multilateral resistances are straightforward to construct*

With data on output and expenditure, and for given values of the elasticity of substitution ( $\sigma$ ) and the vector of bilateral trade costs ( $t_{ij}$ ), the multilateral resistances can be calculated using equations (2-2) and (2-3).

As emphasized by Anderson and Yotov (2010b), the system of equations (2-2) and (2-3) can be solved for  $\{\Pi_i, P_j\}$  only up to a scalar ( $\lambda$ ), implying that if  $\{\Pi_i^0, P_j^0\}$  is a solution then so is  $\{\lambda \Pi_i^0, P_j^0 / \lambda\}$ . Therefore, a normalisation is required.<sup>3</sup> A natural normalisation procedure sets the inward multilateral resistance for a country of choice (usually the country with the most reliable data) to be equal to one ( $P_R = 1$ , where  $R$  is the reference country). An alternative normalisation strategy,

when counterfactual experiments are performed, is to choose a country that presumably will not be affected much by the counterfactual shock. The idea is that if the reference group is not affected then the “relative” counterfactual changes in the multilateral resistances indexes will be much closer to their “absolute” counterparts. Regardless of the normalisation choice, it is important to remember that the values of all multilateral resistance terms (both inward and outward) can only be solved in relative terms with respect to the country of choice. There are at least three approaches to solve system (2-2)-(2-3) for the multilateral resistance terms:

- (i) Subject to a normalisation, system (2-2)-(2-3) can be directly solved for the multilateral resistance terms  $\Pi_i$  and  $P_j$ . A disadvantage of this approach is that system (2-2)-(2-3) are highly non-linear in  $\Pi_i$  and  $P_j$ .
- (ii) This challenge can be overcome by noticing that system (2-2)-(2-3) becomes a quadratic system when expressed in terms of the power transforms of the multilateral resistances,  $\Pi_i^{1-\sigma}$  and  $P_j^{1-\sigma}$ . Then, the simple quadratic system (2-2)-(2-3) can be solved easily with any software supporting non-linear solvers.
- (iii) Finally, as demonstrated in Section 2, the multilateral resistance terms can actually be recovered directly from the importer and from the exporter fixed effects when the structural gravity model is estimated with the PPML estimator.

### 6. *The multilateral resistances are appealing for practical purposes*

In combination, the above properties make the multilateral resistance indexes very appealing for practical purposes from both a policy and structural estimation perspective:

- (i) From a policy perspective, the multilateral resistance terms should be viewed as informative indexes that summarize the general equilibrium effects of trade costs and that can be used to aggregate and decompose the impact of trade policy on consumers and producers in the liberalizing and others (non-members) countries. In addition, as demonstrated in section 2.(d), the multilateral resistances can be used to construct a series of other summary measures of the effects of trade costs and policy.
- (ii) From a structural estimation perspective, the solid theoretical foundation of the multilateral resistance terms makes them an appealing alternative to reduced-form specifications. Two benefits of the structural use of the multilateral resistance terms in estimations are worth mentioning. First, the estimation of the structural gravity model enables to recover and interpret structurally the estimates of the coefficients on the multilateral resistances terms. Anderson et al. (2015c; 2016a) capitalize on this property to recover estimates of the elasticity of substitution from a structural equation that links income to trade openness in the spirit of Frankel and Romer (1999). Second, potential endogeneity concerns can be addressed with a theory-consistent approach.

#### (b) **General equilibrium effects of trade policy**

This section offers an intuitive discussion of the general equilibrium effects of trade policy by describing the underlying links and causal mechanisms between trade policy and economic outcomes within the structural gravity model.<sup>4</sup> Combining the system of equations (2-1)-(2-3) with the market

clearing condition (2-4) and aggregate expenditure expressed in terms of nominal income (2-5) enables to establish a structural gravity system decomposing the effects of trade policy on trade into three different channels (Head and Mayer, 2014):<sup>5</sup>

$$\left. \begin{array}{l} \text{Full} \\ \text{Endowment:} \\ \text{GE} \end{array} \right\} \left\{ \begin{array}{l} \text{Direct (PE):} \\ \text{Conditional} \\ \text{GE} \end{array} \right. \left\{ \begin{array}{l} X_{ij} = \frac{Y_i E_j}{Y} \left( \frac{t_{ij}}{\Pi_i P_j} \right)^{1-\sigma} \quad (2-1) \\ \Pi_i^{1-\sigma} = \sum_j \left( \frac{t_{ij}}{P_j} \right)^{1-\sigma} \frac{E_j}{Y} \quad (2-2) \\ P_j^{1-\sigma} = \sum_i \left( \frac{t_{ij}}{\Pi_i} \right)^{1-\sigma} \frac{Y_i}{Y} \quad (2-3) \\ \rho_i = \left( \frac{Y_i}{Y} \right)^{\frac{1}{1-\sigma}} \frac{1}{\alpha_i \Pi_i} \quad (2-4) \\ E_i = \varphi_i Y_i = \varphi_i \rho_i Q_i \quad (2-5) \end{array} \right.$$

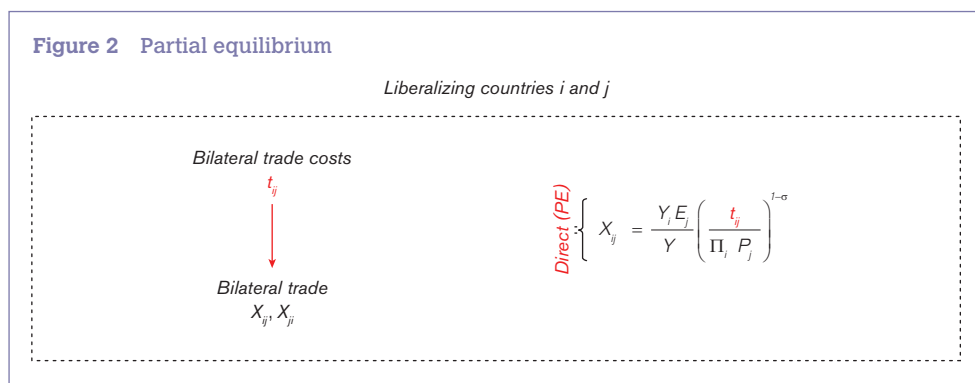
As demonstrated in Appendix B, the structural gravity system (2-1)-(2-5) defined at the aggregate level can also be extended to the sectoral level. Overall, the structural gravity system (2-1)-(2-5) not only enables to decompose the different channels through which trade policy impacts trade, but also to evaluate the relative importance of these channels in the overall impact of trade policy on trade. For clarity and tractability purposes, the analysis presented below is based on a **hypothetical bilateral trade liberalization scenario**, such as the establishment of a RTA between countries  $i$  and  $j$ .

### 1. Partial equilibrium (PE) effects

The direct/partial equilibrium effect of a decrease in bilateral trade costs between countries  $i$  and  $j$  is the initial and, most likely, the strongest effect of trade liberalization on bilateral trade between the two liberalizing countries. As depicted in Figure 2, the partial equilibrium trade creation effect is captured by adjusting the bilateral trade cost ( $t_{ij}$ ) in equation (2-1), while holding national output ( $Y_i$ ) and expenditure ( $E_j$ ), world output ( $Y$ ), and multilateral resistances ( $\Pi_i$  and  $P_j$ ) constant.

By definition, the direct effects of trade policy changes are limited to liberalizing members only, and have no implications for trade and welfare of other countries. For example, a 10 percent decrease in bilateral trade costs between partners  $i$  and  $j$  will translate into a  $(0.9^{1-\sigma} - 1) \times 100$  percent increase in bilateral trade between the two countries, with zero effects on the rest of the countries in the world, where  $\sigma$  is the elasticity of substitution. As presented in section B.3 of Chapter 1, the

structural gravity model also allows for a convenient conversion of any partial equilibrium decrease in trade costs into a corresponding tariff equivalent.



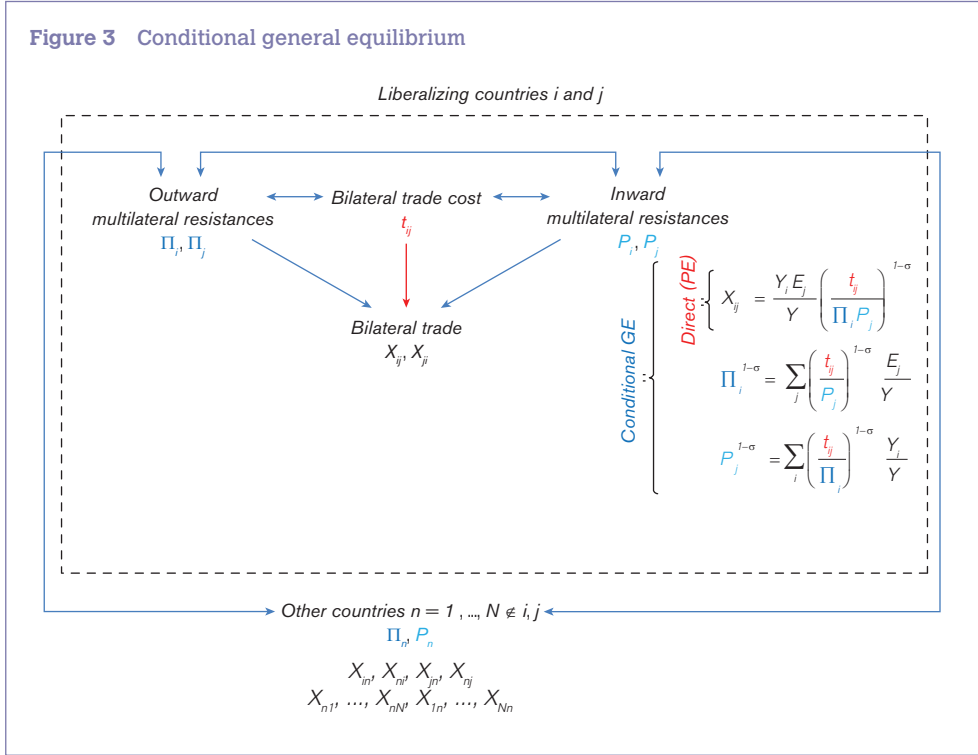
## 2. Conditional general equilibrium effects

An important limitation of the partial equilibrium analysis of the effects of trade policy is that, by construction, the trade policy is assumed to have no impact on other countries (e.g. non-parties to the RTA). This drawback is overcome by the structural gravity model, which provides a tractable general equilibrium analysis framework operating via the multilateral resistance channels, captured by equations (2-2) and (2-3), in addition to the partial equilibrium effects captured by equation (2-1).

This scenario is qualified as “conditional”, because output ( $Y_i$ ) and expenditure ( $E_j$ ) are assumed to remain unchanged following the bilateral trade liberalization between countries  $i$  and  $j$ . However, as depicted in Figure 3, this scenario is also labelled as a “general equilibrium”, because it allows for the effects of trade liberalization between two countries  $i$  and  $j$  ( $t_{ij}$ ) to ripple through the rest of the world via the general equilibrium multilateral resistance terms ( $\Pi_i$  and  $P_j$ ).

The “conditional general equilibrium” step may seem redundant, because, as discussed above, the “partial equilibrium” effects of trade policy can be translated directly into “full endowment general equilibrium” effects, without the need to perform this intermediate step.<sup>6</sup> That being said, analysing the “conditional general equilibrium” scenario as a standalone intermediate step between the “partial equilibrium” analysis and the “full endowment general equilibrium” scenario offers at least four benefits:

- (i) From an instructional perspective, and as highlighted in Anderson and van Wincoop (2003), it is important to understand that a change in bilateral trade costs between any two countries will trigger general equilibrium effects that affect the trade costs, and their incidence on consumers and producers, in any other country in the world, even if everything else (e.g. country size) remains the same.
- (ii) From a policy perspective, the “conditional general equilibrium” scenario delivers *total* bilateral trade cost indexes as a combination of the *direct* bilateral trade costs and the corresponding general equilibrium components that are captured by the multilateral resistances, at given output and expenditure levels.



- (iii) From a theoretical perspective, the construction of the conditional trade costs indexes enables to decompose the effects of trade liberalization into the impacts on trade costs and on economic size, separately. As discussed in Section B.1 in Chapter 1, for given output sizes captured by the first term of the structural gravity equation (2-1),  $Y_i E_j / Y$ , the second structural term,  $\left( t_{ij} / (\Pi_i P_j) \right)^{1-\sigma}$ , measures the conditional general equilibrium effects of trade policy on trade costs.
- (iv) From a practical perspective, and as demonstrated in Section C, the conditional general equilibrium indexes can be recovered directly from the PPML estimates of the fixed effects associated with the structural gravity model, ensuring a perfect and consistent mapping between theory and empirical analysis.

For expositional reasons, the effects on the liberalizing countries and on the other countries in the conditional general equilibrium scenario are discussed separately. The impacts of bilateral trade liberalization on the liberalizing (or member) countries are defined as “first-order general equilibrium effects”, because they are, by construction, the strongest in magnitude. Conversely, the impacts on outside (or non-member) countries are labelled as “second-order general equilibrium effects”, because they are the results of changes in the member countries’ multilateral resistances.

**Conditional general equilibrium effects on member countries.** As shown in Figure 3, the liberalizing countries' "first-order general equilibrium effects" materialize through two different channels: (1) the inward multilateral resistances and (2) the outward multilateral resistances. Both are presented separately below.

**First-order general equilibrium effects through inward multilateral resistances.** Part of the first-order general equilibrium effects of trade liberalization on member countries are channelled through the inward multilateral resistance,  $P_j$ , which according to equation (2-3) suggests that:

- (i) The inward multilateral resistances will decrease for both liberalizing countries following their bilateral trade liberalization.
- (ii) The effects for each liberalizing country will be stronger the larger is the partner country's size.

All else equal, equation (2-1) reveals that the fall in the inward multilateral resistance will work in the opposite direction of the direct effect of trade liberalization. In other words, a fall in inward multilateral resistances will cause country  $j$  to import less from all source countries, including  $j$ , *ceteris paribus*. These trade diversion effects, often feared by policy makers and popular observers, arise because the more integrated country  $j$  is with a particular trading partner  $i$  the more remote it becomes relative to all other countries. When the variety from source  $i$  becomes cheaper, consumers in country  $j$  will substitute away from all other varieties. Alternatively, using the price index interpretation of  $P_j$ , the partner country  $i$  gains market share in country  $j$  (because of the direct/partial effect of trade liberalization), whereas country  $j$ 's import market becomes more competitive for non-member countries.

By construction, the decrease in each liberalizing country's inward multilateral resistances will always be smaller in magnitude than the decrease in bilateral trade costs between the two liberalizing countries (i.e.  $\Delta t_{ij} > \Delta P_j$ ). The reason is that, by construction, the change in inward multilateral resistances is obtained as a weighted average of the changes in all bilateral trade costs, where the change in trade costs between the liberalizing countries plays only a small role that depends on their size. As a result, trade diversion effects due to the fall in inward multilateral resistances will never be strong enough to offset the direct trade creation effect of the decrease in bilateral trade costs between the liberalizing countries.

**First-order general equilibrium effects through outward multilateral resistances.** The other first-order general equilibrium effects of trade liberalization on member countries are channelled via the outward multilateral resistances,  $\Pi_j$ , which, based on equation (2-2), implies that:

- (i) The outward multilateral resistances will decrease for both liberalizing countries as a result of their bilateral trade liberalization.
- (ii) The effects for each liberalizing country will be stronger the larger is the partner country's size.

Similar to the effect of the decrease of inward multilateral resistances, equation (2-1) suggests that each liberalizing member's exports to all countries will decrease following the decrease in outward multilateral resistances. These trade-diversion effects occur because for a given total output, country  $i$  will export more to country  $j$  and less to every other country, when it experiences lower export costs to this particular partner  $j$ . In other words, the more integrated country  $i$  is with its trading partner  $j$ , the more remote it becomes relative to all other countries. Although, the general



equilibrium trade diversion effects channelled through the outward multilateral resistances can be quite substantial, they will not, by construction, be strong enough to offset the direct trade creation effects due to trade liberalization between the liberalizing countries (i.e.  $\Delta t_{ij} > \Delta \Pi_i$ ).

**Conditional general equilibrium effects on non-member countries.** As explained above, an important implication of the “conditional general equilibrium” scenario is that it translates the effects of trade liberalization between countries  $i$  and  $j$  to changes in trade (and welfare) for all other countries in the world. These second-order effects, triggered by changes in the liberalizing countries’ multilateral resistance terms described above, are also channelled through the multilateral resistances. Specifically, equations (2-2) and (2-3) imply that:

- (i) The non-member countries’ outward and inward multilateral resistances will typically increase as a result of the decrease in the liberalizing countries’ outward and inward resistance terms.
- (ii) The effects for each non-member country will be stronger the larger are the liberalizing countries’ sizes.

According to equation (2-1), the increase in non-member countries’ outward and inward multilateral resistance terms will typically, all else being equal, lead to an increase in exports and imports between non-member countries. These trade creation effects arise because, at constant output levels, once non-member countries’ imports and exports are diverted from the liberalizing members (who trade more with each other and less with non-member countries), they will be redirected to other non-member countries and to domestic sales.

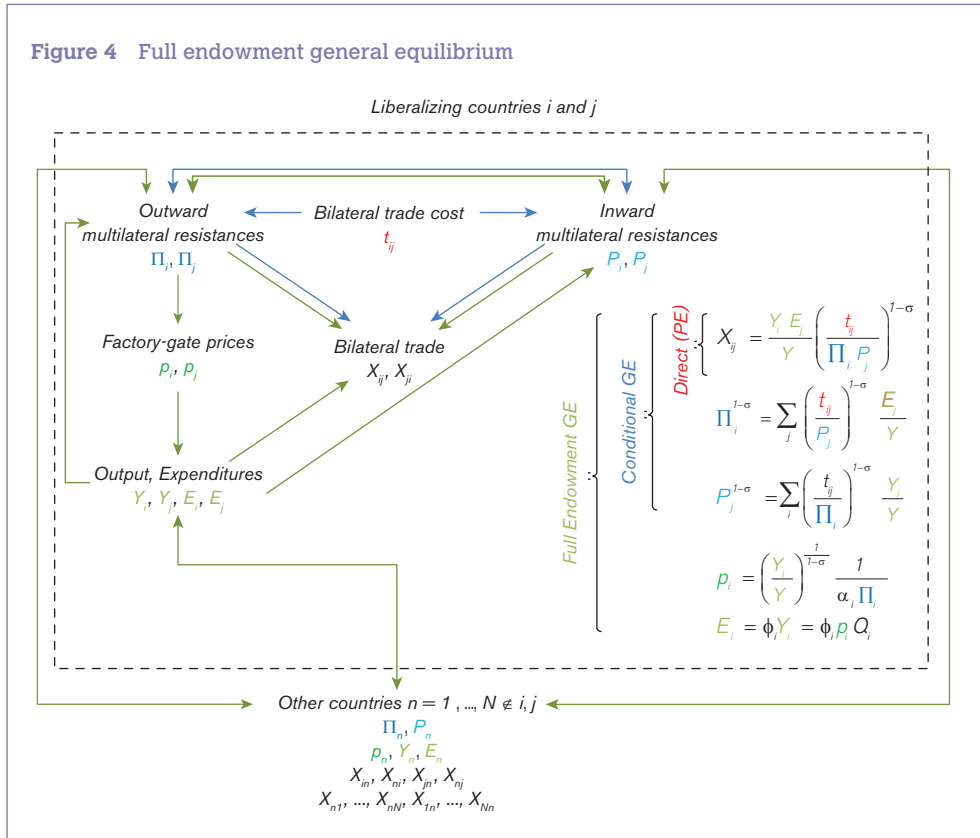
In order to determine the net impact on non-member countries, it is necessary to distinguish between the impact on (1) trade between liberalizing and non-member countries, and on (2) trade among non-member countries. As described above, the first-order trade diversion effects imply that trade between member and non-member countries will be impacted negatively, while the second-order trade creation effects on trade among non-member countries will be unambiguously positive. Since part of non-members’ diverted trade associated with the second-order effects will lead to an increase in *intra-national* trade, the net effect on non-member countries’ international trade will most likely be negative. It is, however, theoretically possible that the net impact on some non-member countries’ trade turns out to be positive, if these non-member countries face very large (prohibitive at the extreme) trade costs with the liberalizing countries. These non-member countries will not be impacted negatively by trade diversion associated with the formation of the RTA, because they traded very little (if at all) with the liberalizing countries in the first place. In addition, some of these non-member countries (outsiders 1) may be good trading partners of other non-member countries (outsiders 2) that actually suffer significant trade diversion resulting from the formation of the RTA. Thus, in principle, it is possible that part of outsiders 2’s exports, which have been diverted from the liberalizing countries, will now be redirected to outsiders 1. That being said, such a scenario remains unlikely given the current levels of integration and interdependence in the world trading system.

**Third-order general equilibrium effects on member and non-member countries.** Although not discussed in details here, it is important to note that changes in the non-member countries’ multilateral resistances will lead to “third-order general equilibrium effects” on the liberalizing countries as well as on the non-member countries themselves. However, these third-order effects will be, by definition, dominated by the first- and second-order general equilibrium effects presented above.

### 3. Full endowment general equilibrium effects

The third general equilibrium channel through which trade liberalization between countries  $i$  and  $j$  will affect trade among all economies in the world is labelled “full endowment general equilibrium effects”. This scenario refers to *full*, because, as shown in Figure 4, this channel endogenizes the value of output/national income ( $Y_i$ ) and expenditure ( $E_i$ ) by allowing factory-gate prices ( $p_i$ ) to respond to trade cost changes ( $t_{ij}$ ) and the associated ripple effects in multilateral resistances ( $\Pi_i$  and  $P_j$ ), via equation (2-4), and then translate these changes in factory-gate prices ( $p_i$ ) into changes in the value of domestic production ( $Y_i$ ) and aggregate expenditure ( $E_i$ ), via equation (2-5). Each country  $i$ 's production  $Q_i$  is assumed to be constant throughout the analysis. That is why this scenario is labelled *endowment*, in order to distinguish it from the general equilibrium effects in a scenario, where production quantities are also endogenous with respect to trade and trade policy. Such a scenario, which allows for endogenous changes in production ( $Q_i$ ) through the accumulation of physical capital in a dynamic gravity setting, is presented in the next sub-section.

As shown in Figure 4, the direct impact of the change in bilateral trade cost ( $t_{ij}$ ) on the value of domestic output ( $Y_i$ ) and expenditure ( $E_i$ ) will have additional ripple effects throughout the



structural gravity system (2-1)-(2-5) on the multilateral resistances ( $\Pi_i$  and  $P_j$ ), factory-gate prices ( $p_j$ ), output ( $Y_j$ ), expenditure ( $E_j$ ) and trade ( $X_{ij}$ ). Each of the main full endowment general equilibrium effects is presented separately.

*Direct general equilibrium effects on the value of output.* As explained above, equations (2-4) and (2-5) capture how the decreases in the outward multilateral resistances ( $\Pi_i$ ), defined as a first-order general equilibrium effect for member countries, formally translate into higher factory-gate prices ( $p_j$ ) and, in turn, higher output values ( $Y_j$ ) and expenditure ( $E_j$ ). The positive impact on output values and expenditures stems from the fact that the producers in the liberalizing member countries will internalize the favourable change in their outward multilateral resistances by increasing their prices. The opposite will happen in non-member countries, where producers will experience higher outward resistance and be forced to decrease their factory-gate prices. The effect on factory-gate prices in non-member countries will be smaller as compared to the effect on member countries because the initial effect on non-member countries' outward multilateral resistances is a second-order effect, as explained previously. In sum, the full endowment general equilibrium effects of trade liberalization on the value of output/nominal income will be positive in the liberalizing countries and likely negative in non-member countries.

*Direct general equilibrium effects of the value of output on trade.* The changes in the value of output/nominal income as a result of the reduction in bilateral trade costs will further lead to additional direct effects on trade, as reported in equation (2-1). All else being equal, both exports and imports in the liberalizing countries will increase following the increase in the value of their output/nominal income, while trade in non-member countries will typically decrease as a result of the reduction in the value of their output/nominal income. The positive direct general equilibrium effects of the value of output on member countries' trade arises because the formation of the RTA leads the member countries to become effectively richer/larger in terms of value of output and expenditure. Conversely, non-members countries become typically poorer/smaller in terms of value of output and expenditure, and as a result experience a reduction in trade. Yet, trade between member and non-member countries is likely to increase via this channel because the first-order effects on the value of output/income for member countries are stronger than the effects on non-member countries. Importantly, the trade creation size effects can be strong enough to outweigh the conditional general equilibrium trade diversion effects on trade in non-member countries.

*Indirect general equilibrium effects of the value of output on multilateral resistances.* In addition to their direct impact on trade, the changes in the value of output will have indirect effects on trade through changes in the inward and outward multilateral resistances ( $\Pi_i$  and  $P_j$ ), as captured by equations (2-2) and (2-3). Due to their increased size, the liberalizing countries will be assigned more weight in the construction of the multilateral resistances. As a result, the impact of trade liberalization among the member countries on all countries will be magnified via this channel. However, by construction, this effect will never be stronger than the first- and second-order conditional general equilibrium effects discussed above, because it was initially triggered by changes in the multilateral resistances. The changes in the multilateral resistance terms will further lead to additional third-order changes in output.

### (c) Nested gravity: a dynamic gravity framework

The objective of this section is to demonstrate how the base structural gravity system derived and discussed in detail so far can be nested within a wide class of production superstructures, which thus, opens avenues for a series of more rigorous and more realistic general equilibrium analysis of the effects of trade policies. Importantly, this section demonstrates that this can be achieved without any modifications to the original structural gravity system and, therefore, all features and properties that were presented so far will be preserved and valid.

As demonstrated by Anderson et al. (2015c; 2015d) the structural gravity model can be integrated with a dynamic model of endogenous production and capital accumulation in the spirit of Lucas and Prescott (1971) in order to deliver a simple and tractable dynamic general equilibrium framework establishing a quantifiable relationship between trade liberalization and growth. In particular, retaining all the assumptions made in Chapter 1 and the previous section, the  $N$ -country Armington model is nested within a dynamic superstructure where representative households maximize the present discounted value of their lifetime utility. In addition to choosing how they source consumption (as before), consumers now also make endogenous decisions over how much to invest. The representative consumer's problem becomes:

$$\max_{\{C_{j,t}, \Omega_{j,t}\}} \sum_{t=0}^{\infty} \gamma^t \ln(C_{j,t}) \quad (2-6)$$

$$s.t. \quad Y_{j,t} = P_{j,t} C_{j,t} + P_{j,t} \Omega_{j,t} \quad (2-7)$$

$$C_{j,t} = \left( \sum_i \alpha_i^{\frac{1-\sigma}{\sigma}} c_{ji,t}^{\frac{\sigma}{\sigma-1}} \right)^{\frac{\sigma-1}{\sigma}} \quad (2-8)$$

$$\Omega_{j,t} = \left( \sum_i \alpha_i^{\frac{1-\sigma}{\sigma}} I_{ji,t}^{\frac{\sigma}{\sigma-1}} \right)^{\frac{\sigma-1}{\sigma}} \quad (2-9)$$

$$Y_{j,t} = p_{j,t} A_{j,t} L_{j,t}^{1-\eta} K_{j,t}^{\eta} \quad (2-10)$$

$$E_{j,t} = \varphi_{j,t} Y_{j,t} \quad (2-11)$$

$$K_{j,t+1} = \Omega_{j,t}^{\delta} K_{j,t}^{1-\delta} \quad (2-12)$$

$$K_{j,0} : \text{given} \quad (2-13)$$

Equation (2-6) is the consumer's lifetime logarithmic utility function, which translates aggregate consumption into utility, where  $\gamma < 1$  is the subjective discount factor. Equation (2-7) represents the consumer budget constraint, according to which, at each point of time  $t$ , consumers split their income between aggregate consumption  $C_{j,t}$  and aggregate investment  $\Omega_{j,t}$ . CES aggregate consumption is

defined by equation (2-8). Similarly, equation (2-9) is the CES investment aggregator that combines the investment varieties  $I_{j,t}$  into an aggregate investment good  $\Omega_{j,t}$ . Equation (2-10) defines the value of production. Importantly, the specification of production in equation (2-10) deviates from the original endowment economy assumption by introducing an additional channel, via capital accumulation, which endogenizes production ( $Q_j$ ) in the gravity model. Equation (2-11) relates aggregate expenditures to the value of production via  $\phi_{j,t}$ , indicating a trade deficit of country  $j$  at time  $t$  if  $\phi_{j,t} > 1$  and a trade surplus otherwise. The process of capital accumulation is subject to both a law of motion for the capital stock, given by equation (2-12), as well as known initial values,  $K_{j,0}$  in equation (2-13).<sup>7</sup>

Solving the consumer's optimization problem given by equations (2-6)-(2-13) delivers the following dynamic gravity system of trade and growth:

$$\left. \begin{array}{l} \text{Dynamic} \\ \text{GE} \end{array} \right\} \left\{ \begin{array}{l} \text{Full} \\ \text{Endowment:} \\ \text{GE} \end{array} \right\} \left\{ \begin{array}{l} \text{Conditional} \\ \text{GE} \end{array} \right\} \left\{ \begin{array}{l} \text{Direct:} \end{array} \right.$$

$$\begin{aligned}
 X_{j,t} &= \frac{Y_{i,t} E_{j,t}}{Y_t} \left( \frac{t_{j,t}}{\Pi_{i,t} P_{j,t}} \right)^{1-\sigma} & (2-14) \\
 \Pi_{i,t}^{1-\sigma} &= \sum_j \left( \frac{t_{j,t}}{P_{j,t}} \right)^{1-\sigma} \frac{E_{j,t}}{Y_t} & (2-15) \\
 P_{j,t}^{1-\sigma} &= \sum_i \left( \frac{t_{j,t}}{\Pi_{i,t}} \right)^{1-\sigma} \frac{Y_{i,t}}{Y_t} & (2-16) \\
 p_{i,t} &= \left( \frac{Y_{i,t}}{Y_t} \right)^{\frac{1}{1-\sigma}} \frac{1}{\alpha_i \Pi_{i,t}} & (2-17) \\
 Y_{i,t} &= p_{i,t} A_{i,t} L_{i,t}^{1-\eta} K_{i,t}^\eta & (2-18) \\
 E_{i,t} &= \phi_i Y_{i,t} & (2-19) \\
 K_{i,t+1} &= \left[ \gamma \delta \phi_{i,t} \frac{\eta p_{i,t} A_{i,t} L_{i,t}^{1-\eta} K_{i,t}^{\eta-1}}{(1-\gamma + \delta \gamma) P_{i,t}} \right]^\delta K_{i,t} & (2-20)
 \end{aligned}$$

The dynamic gravity system (2-14)-(2-20) is very similar to the static gravity system (2-1)-(2-5) derived in the previous section. In fact, the first four equations of the two systems are absolutely identical, and if the capital accumulation channel is shut off ( $\delta = 0$ ), the dynamic gravity system (2-14)-(2-20) will collapse to the static system (2-1)-(2-5) with the only difference being that the endowment ( $Q$ ) is replaced by the production function (2-18). In other words, the original gravity model is indeed nested, without any modifications, in the endogenous production superstructure with capital accumulation. This feature simplifies the analysis of the dynamic general equilibrium effects of trade policy tremendously, since all general equilibrium links presented in the previous section continue to hold, and all new dynamic general equilibrium linkages will be channelled through equations (2-18) and (2-20), which are the only

differences between the systems (2-14)-(2-20) and (2-1)-(2-5). The rest of the discussion in this section will, therefore, focus on describing equations (2-18) and (2-20).

Equation (2-20) is the policy function for capital, which captures the direct relationship between capital accumulation and the levels of technology, labour endowment, and current capital stock. More importantly, equation (2-20) reveals (i) a direct relationship between capital accumulation and domestic factory-gate prices,  $p_{i,t}$ , and (ii) an inverse relationship between capital accumulation and domestic inward multilateral resistances,  $P_{i,t}$ :

- (i) The intuition for the positive impact of factory-gate prices on capital accumulation is that, all else equal, an increase in  $p_{i,t}$  translates into a higher value of marginal product of capital, captured by the numerator in the square brackets of equation (2-20), which in turn stimulates investment. Given that the factory-gate prices are general equilibrium indexes that, as established earlier, will respond (via the market-clearing conditions) to changes in trade costs between any two countries in the world, a trade policy change in one country will not only affect investment in this country and in its partner countries directly affected by the trade policy, but also in all other countries in the world.
- (ii) The intuition behind the negative relationship between capital accumulation and the inward multilateral resistance,  $P_{i,t}$ , is twofold. First, recognizing that  $P_{i,t}$  is the CES price aggregator for investment goods, the inverse relationship between capital accumulation and  $P_{i,t}$  is simply a reflection of the law of demand. Second, recognizing that  $P_{i,t}$  is also the CES price aggregator for consumption goods, the inverse relationship can also be explained with the fact that when consumption becomes more expensive, the opportunity cost of investment becomes higher, which leads to a reduction in investment, because a higher share of income will be spent on consumption today and less will be saved and transferred for future consumption via capital accumulation. Importantly, as established earlier, the inward multilateral resistances are general equilibrium indexes and, as such, the inward multilateral resistance in one country responds to trade policy changes in any other country in the world. Equation (2-20) translates the general equilibrium changes in the inward multilateral resistances into changes in capital accumulation. Thus, the changes in the inward multilateral resistances can be viewed as embedded capital accumulation effects of trade liberalization.

In turn, the changes in capital in response to trade policy, as captured by equation (2-20), will translate into direct additional changes in the value of output/income via equation (2-18). The effects on trade of the changes in income due to higher level of capital will be qualitatively identical to the effects of the changes in income in response to changes in factory-gate prices from the endowment scenario that was presented earlier. However, it is important to emphasize that (i) the new capital accumulation effects are due to endogenizing production quantities, and (ii) that these effects will act in addition to the effects of factory-gate prices which are still active in the current setting. Similar to the endowment scenario, the new capital accumulation effects on country size will have (i) a direct and (ii) an indirect effect on trade.

- (i) The direct size effect of capital accumulation on trade is positive for the liberalizing countries and it is negative for outsiders, and it is channelled through the gravity equation (2-14). Increased size of the liberalizing economies, due to capital accumulation in response to trade

liberalization, will lead to more trade between them but also to more trade between them and all other countries too. Decreased capital accumulation in outside countries will translate into smaller country size and, therefore, less exports and imports for these countries. It is possible that the increase in size in the liberalizing country due to capital accumulation may actually stimulate exports from non-members to the extent that these effects dominate the standard trade diversion forces triggered by preferential trade liberalization and the negative size effects on non-members.

- (ii) The indirect effect of capital accumulation on trade is channelled through changes in trade costs, via changes in the multilateral resistances, which in turn lead to changes in trade flows. These effects are captured by equations (2-14)-(2-16) and reveal an additional channel through which preferential trade liberalization, such as the formation of a RTA, may benefit non-member countries. By making investment more attractive, a RTA will stimulate growth in the member countries, leading to lower sellers' incidence in the member countries, but also lower buyers' incidence in non-member countries. It should also be noted, however, that more efficient production in liberalizing countries will have a negative impact on the competing producers in non-member economies. Thus, the potential positive impact on non-members through this channel will be more pronounced for higher initial levels of consumption and for lower initial levels of production in non-member countries.

The analysis in this section demonstrated that the structural gravity system can be nested directly and without any modification into a more complex model of production. Anderson et al. (2015c; 2016a) demonstrate that this is also the case for a production structure with capital accumulation and intermediate goods, as well as when capital accumulates subject to a lineal capital accumulation function. In addition, Anderson et al. (2015c; 2016a) show that system (2-14)-(2-20) translates into an intuitive econometric system that is straightforward to estimate and delivers all key structural parameters that are needed in order to perform general equilibrium simulation analysis.

#### (d) General equilibrium effects trade costs and policy indexes

Several general equilibrium trade cost indexes have been developed and are often used in the literature to summarize and decompose various aspects of trade policy effects. As discussed earlier, in order to obtain some of these indexes (e.g. effects on consumer and on producer prices), normalisation is necessary because trade gravity models are homogenous of degree zero in prices. In other words, in the trade gravity models considered in this *Advanced Guide* a change in prices for all countries by the same amount would not change any of the real variables, such as quantities produced. Therefore, a normalisation has to be imposed in order to ensure a unique equilibrium. The normalisation implies that some of the general equilibrium trade policy indexes have to be interpreted with caution and keeping in mind the reference group/country that is used for the normalisation. While some general equilibrium trade policy indexes require normalisation, other indexes (e.g. real GDP and welfare) are independent of any normalisation, because these indexes are constructed as a combination of normalised indexes and the normalisation cancels. Accordingly, the discussion of the general equilibrium indexes in this section are grouped into (1) indexes requiring normalisation, and (2) indexes not requiring normalisation. As demonstrated in the next section, the general equilibrium indexes presented

here be recovered directly or as a combination of the estimated exporter and importer fixed effects of the structural gravity specification.

### 1. General equilibrium effects trade cost indexes subject to normalisation

The indexes presented in this section correspond to some of the equations of the structural gravity system, namely the multilateral resistances which can be recovered from equations (2-2)-(2-3), and the market clearing condition, which can be constructed from equation (2-4). A common feature and potential caveat of the multilateral resistances and factory-gate prices is that these indexes can only be obtained with a normalisation, that is be expressed in relative form with respect to a reference group. As a result, these indexes can be compared consistently across countries for a given sector and year, but the required normalisation makes comparisons over time and across sectors difficult. A possible remedy is to choose as a reference group a country for which reliable data are available across all dimensions for the index of interest and, subsequently, these data series can be used to adjust all indexes in order to perform comparisons across any dimension. Alternatively, and as explained above, it might be useful to choose a reference group that is expected to be affected the least from the counterfactual shock. Thus, the relative impact for all affected parties can be expected to approximate closely the corresponding absolute effect

**Inward multilateral resistance indexes.** As discussed above and in Section B.1. in Chapter 1, the inward multilateral resistances  $P_j$  are theory-consistent general equilibrium aggregate indexes that measure the incidence of trade costs on each country's consumers as if these consumers buy from a unified world market. Thus, the inward multilateral resistances, formulated in equation (2-3), can be used to evaluate the effects of domestic and foreign trade policy on consumers in each country.

An alternative definition of  $P_j$ , which is also consistent with the structural gravity model, is as a CES price aggregator:

$$P_j = \left[ \sum_i (\alpha_i p_i t_{ij})^{1-\sigma} \right]^{\frac{1}{1-\sigma}} \quad (2-21)$$

Based on this definition,  $P_j$  can be interpreted as *supplier access indexes* (Redding and Venables, 2004). In their role as CES aggregators, the inward multilateral resistances may, in principle, be interpreted as ideal price indexes, and their variation across countries might be expected to reflect variation in consumer price indexes (CPIs). However, inward multilateral resistances may have more variation than the corresponding CPIs and as a result only loosely track variations in CPIs. The differences between inward multilateral resistances and CPIs have a number of possible explanations (Anderson and Yotov, 2010b). First, the inward incidence of trade costs probably falls on intermediate goods users in a way that does not show up in measured prices. Second, the production weighted inward multilateral resistances are not really conceptually comparable to the consumer price indexes of final goods baskets. Third, the inward multilateral resistances may capture home bias in preferences, which results in attributions to trade costs that cannot show up in prices. Finally, the inward multilateral resistances may be subject to measurement error and the CES model on which they are based may itself be mis-specified.



**Outward multilateral resistance indexes.** Similarly, as explained earlier, the outward multilateral resistances  $\Pi_i$  are theory-consistent general equilibrium aggregates of the incidence of trade costs on each country's producers, as if they ship to a unified world market. The outward multilateral resistances indexes, defined in equation (2-2), can be used in combination with the inward multilateral resistances indexes to decompose the incidence of trade costs on the consumers and the producers in each country (Anderson and Yotov, 2010b). Different alternative interpretations have been given to outward multilateral resistances in the literature, such as *market access* indexes (Redding and Venables, 2004) and *total factor productivity frictions in distribution* (Anderson and Yotov, 2010a).

**Factory-gate price indexes.** Factory-gate prices indexes  $p_i$  and their changes in response to trade policy can be obtained from the market-clearing conditions expressed in equation (2-4). The factory-gate prices can be used as a complementary index to the outward multilateral resistances in order to evaluate the effects of trade policy and trade cost changes on producers. In addition, as discussed in Section C, the changes in factory-gate prices in response to trade cost changes serve as an important link for integrating the structural gravity model with a series of general equilibrium production models that depart from the endowment economy setting of Anderson (1979) and Anderson and van Wincoop (2003).

## 2. General equilibrium effects trade cost indexes independent of normalisation

An important use of the multilateral resistances and factory-gate price indexes discussed above is to combine them in order to construct more complex and informative complementary general equilibrium indexes that provide additional insights about the effects of trade policy. However, unlike the standard structural terms ( $\Pi_i$ ,  $P_j$  and  $p_i$ ), the general equilibrium indexes presented and discussed below are, by construction, all independent of the normalisation required to compute the multilateral resistances and the factory-gate prices.

**Constructed trade bias.** Based on the structural gravity model, the *constructed trade bias (CTB)* index, proposed by Agnosteva et al. (2014), is defined as the ratio of the econometrically predicted trade flow  $\hat{X}_{ij}$  to the hypothetical frictionless trade flow between origin  $i$  and destination  $j$ :<sup>8</sup>

$$CTB_{ij} = \frac{\hat{X}_{ij}}{Y_i E_j / Y} = \left( \frac{\hat{t}_{ij}}{\hat{\Pi}_i \hat{P}_j} \right)^{1-\sigma} \quad (2-22)$$

The right-hand side of equation (2-22) corresponds to the predicted/constructed value of the composite trade cost term from the structural gravity equation (2-1). The *CTB* index is therefore a measure of the combined (direct, via the bilateral trade costs  $t_{ij}$ , and indirect, via the multilateral resistance terms  $\Pi_i$  and  $P_j$ ) effects of trade policy, or other trade costs changes, on bilateral trade, making it the most flexible general equilibrium trade cost index. The *CTB* index can be constructed in a conditional general equilibrium setting for given output and expenditure, but also in a full general equilibrium scenario that accounts for the effects of trade policy on the country's output and expenditure.

Besides being independent of the normalisation required to solve the system of equations (2-2) and (2-3) of the multilateral resistances, the *CTB* index displays four other appealing properties (Agnosteva et al., 2014):

- (i) The *CTB* index is independent of the elasticity of substitution  $\sigma$ , because it is constructed using the inferred volume effects that are due to power transforms of the bilateral trade costs  $t_{ij}^{1-\sigma}$  and the multilateral resistances  $\Pi_i^{1-\sigma}$  and  $P_j^{1-\sigma}$ .
- (ii) The *CTB* index, as a conditional expectation, shares the gravity model's good fit properties to infer central tendency out of the random errors that notoriously affect mis-measured bilateral trade flow data.
- (iii) The *CTB* index can be extended and consistently aggregated to yield the family of general equilibrium indexes that capture the effects of trade policy on trade costs at various levels of regional aggregation. For example, Anderson and Yotov (2010) introduce the *constructed home bias (CHB)* as the ratio of predicted to hypothetical frictionless internal trade within a given country. Intuitively, the *CHB* measures how far the economy is from a frictionless trade equilibrium. In that sense, the *CHB* is a complementary index to the widely popular *sufficient welfare statistic* of Arkolakis, Costinot and Rodriguez-Clare (2012) discussed below. Anderson et al. (2014) propose the *constructed foreign bias (CFB)* index, defined as the predicted volume of international export trade relative to the hypothetical frictionless volume of trade, and the *constructed domestic bias (CDB)* index, which corresponds to the ratio of fitted to frictionless intra-national trade, excluding trade within sub-regions in a country. The *CFB* index may be particularly useful to assess the effects of trade policy on international trade, while the *CDB* index can be used to evaluate the intra-national effects of trade policy.
- (iv) Finally, the *CTB* index has a general equilibrium counterpart that can be constructed directly from the data, in the spirit of the ratio calibration approaches that are used in the trade literature to recover bilateral trade costs, and which are discussed in the next section. Specifically, if actual trade is used instead of fitted trade, the *trade bias (TB)* index can be constructed as:

$$TB_j \equiv \frac{X_j}{Y_j E_j / Y} \quad (2-23)$$

The *TB* index can still be interpreted as the total bilateral trade cost between  $i$  and  $j$ . Furthermore, it can be constructed easily, without having to estimate the gravity model, but at the cost of being subject to measurement error.

**Terms of trade.** It is well known that the *terms of trade (ToT)* and their changes in response to trade policy are notoriously hard to measure, especially if the objective is consistent measurement and comparison across countries, sectors, and time. The structural gravity model offers a convenient solution to obtain consistent *ToT* indexes, defined as follows (Anderson and Yotov, 2016):

$$ToT_i \equiv \frac{\hat{p}_i}{\hat{P}_i} \quad (2-24)$$

where  $\hat{p}_i$  represents the constructed values of the factory-gate prices, namely the producer price in country  $i$ , and  $\hat{P}_i$  is the constructed inward multilateral resistance capturing the corresponding consumer price in country  $i$ . Under the endowment economy assumption of the Armington gravity model, the *ToT* index can be interpreted as a welfare/real income measure, because the numerator in equation (2-24) can be interpreted as the change in nominal income  $\hat{p}_i = p_i \hat{Q}_i$  in country  $i$  in response to trade cost changes, while the denominator in equation (2-24) can be interpreted as the change in consumer prices in country  $i$  in response to the same trade cost changes.

While perfectly consistent with the structural gravity model, the *ToT* index formulated in equation (2-24) departs from the conventional definition of *barter of terms of trade*, presented in Chapter 1 of the *Practical Guide to Trade Policy Analysis* and defined as the ratio of *exporter* prices over *importer* prices because, by construction, the factory-gate prices ( $\hat{p}_i$ ) and the inward multilateral resistances ( $\hat{P}_i$ ) take into account *intra-national* trade flows. An easy solution is to solve the multilateral resistance system of equations (2-2) and (2-3) without the *intra-national* links:  $P_j^{1-\sigma} = \sum_{i \neq j} (t_{ij}/\Pi_i)^{1-\sigma} (Y_i/Y)$  and  $\Pi_i^{1-\sigma} = \sum_{j \neq i} (t_{ij}/P_j)^{1-\sigma} (E_j/Y)$ . The resulting outward multilateral resistance terms  $\Pi_i$  can then be used to construct corresponding factory-gate prices.

**Sufficient welfare statistics.** In a recent and very influential paper, Arkolakis, Costinot and Rodriguez-Clare (2012) have demonstrated that the welfare (real consumption) gains from trade liberalization obtained from a wide class of trade models with alternative micro-foundations can all be expressed as a combination of two sufficient statistics: (1) the change in intra-national trade as share of total expenditure, and (2) trade elasticity.<sup>9</sup> In the context of the baseline structural gravity model considered in this *Advanced Guide*, the general equilibrium welfare gain statistics (*WS*) from trade can be expressed as the ratio between the counterfactual welfare value obtained in response to a change in trade costs and the welfare value prevailing in the baseline scenario:

$$WS_i \equiv \frac{W_i^{CFL}}{W_i^{BLN}} = \left( \frac{\lambda_{ii}^{CFL}}{\lambda_{ii}^{BLN}} \right)^{\frac{1}{1-\sigma}} \quad (2-25)$$

where  $W_i = E_i/P_i$  denotes welfare/real consumption in country  $i$ ,  $\lambda_{ii} = X_{ii}/E_i$  is the share of expenditure on home goods,  $\sigma$  is the elasticity of substitution, and superscripts *CFL* and *BLN* denote values in the counterfactual and baseline scenario, respectively.

## 2. Standard approach to general equilibrium analysis with structural gravity

Capitalizing on solid micro-foundations, both on the supply side (Eaton and Kortum, 2002) and on the demand side (Anderson and van Wincoop, 2003), and on tight connection to the data (Costinot and Rodriguez-Claire, 2014), counterfactual analysis of the effects of various trade policies using the gravity model has been the object of a series of recent studies.<sup>10</sup> This section outlines and discusses the standard steps required to perform general equilibrium counterfactual experiments with the gravity model.

The departing point of the general equilibrium analysis is the structural gravity system:

$$X_{j,t} = \frac{Y_{i,t} E_{j,t}}{Y_t} \left( \frac{t_{j,t}}{\Pi_{i,t} P_{j,t}} \right)^{1-\sigma} \quad (2-1)$$

$$\Pi_{i,t}^{1-\sigma} = \sum_j \left( \frac{t_{j,t}}{P_{j,t}} \right)^{1-\sigma} \frac{E_{j,t}}{Y_t} \quad (2-2)$$

$$P_{j,t}^{1-\sigma} = \sum_i \left( \frac{t_{j,t}}{\Pi_{i,t}} \right)^{1-\sigma} \frac{Y_{i,t}}{Y_t} \quad (2-3)$$

$$p_{i,t} = \left( \frac{Y_{i,t}}{Y_t} \right)^{\frac{1}{1-\sigma}} \frac{1}{\alpha_i \Pi_{i,t}} \quad (2-4)$$

$$E_{i,t} = \varphi_i Y_{i,t} = \varphi_i p_{i,t} Q_{i,t} \quad (2-5)$$

### Step 1: Solve the baseline gravity model

The first stage consists in solving the gravity model in the baseline while describing the actual data as closely as possible, ideally perfectly. This stage requires estimates of the key structural parameters, such as trade costs and trade elasticities, which, in combination with actual data on, for instance, trade and production, will be combined to obtain the key indexes of interest, such as the consumer prices and real GDP, in the baseline scenario. For instructional purposes, this step can be decomposed into three sub-stages:

**Step 1.a: Obtain estimates of trade costs and trade elasticities baseline indexes.** This first step consists of obtaining estimates of the bilateral trade costs, including estimates of the elasticities of bilateral trade with respect to bilateral trade policy. Ideally, the analysis in this step will deliver estimates of all relevant trade costs and elasticity parameters that capture the response of bilateral trade with respect to bilateral trade policies, such as RTAs or bilateral tariffs, as well as non-discriminatory export-promotion policies, and non-discriminatory import-protection policies, such as MFN tariffs. Three possible approaches to obtain trade costs and trade elasticities have been proposed and used in the existing literature:

- (i) **Estimation:** Obtaining trade costs and trade elasticities by estimating the structural gravity model offers a number of advantages. First, by design, the estimation approach accounts for measurement error in the data. Second, it enables researchers to establish causal relationships between key variables of interest and trade instead of simply assuming that such relationships hold (Krugman, 2011; Dawkins et al., 2001). In fact, this is the main objective of hundreds of papers that use the gravity model to study the effects of various determinants of trade. Third, the estimation approach enables to decompose the effects of various trade components within the same data that will be used in the counterfactuals. Fourth, capitalizing on the remarkable predictive power of the gravity model, the estimation approach can be extended to obtain out-of-sample trade cost estimates, even when corresponding trade data are missing. This is demonstrated in Box 3. Finally, obtaining the own trade costs and elasticity estimates is valuable for validation purposes, because one can compare these estimates with existing counterparts from the literature. For all of the above reasons, researchers should, when reliable data are available, attempt to obtain their own trade cost and trade elasticity estimates from the same sample that will be used in the counterfactuals. A drawback of the estimation approach is that the error term may contain systematic information about trade costs. Possible approaches to address this issue are discussed below.

The following generic econometric gravity model can be estimated in order to obtain estimates of trade costs and trade elasticities:

$$X_{j,t} = \exp\left[\pi_{i,t} + \chi_{j,t} + \mu_{ij} + \beta_1 RTA_{j,t} + \beta_2 ES_{i,t} \times INTL_{ij} + \beta_3 MFN_{j,t} \times INTL_{ij}\right] \times \varepsilon_{j,t} \quad (2-26)$$

As recommended in Chapter 1, specification (2-26) should preferably be estimated with the PPML estimator, using panel *intra-national* and *international* trade data with year intervals, and controlling for *exporter-time* fixed effects ( $\pi_{i,t}$ ), *importer-time* fixed effects ( $\chi_{j,t}$ ), and pair fixed effects ( $\mu_{ij}$ ). The generic econometric gravity model (2-26) enables to estimate the effects of three types of trade policy: (i) bilateral trade policy; (ii) unilateral export-promotion policy; and (iii) non-uniform trade-protection policy. The representative bilateral trade policy corresponds to the variable  $RTA_{j,t}$ , which indicates the presence of a RTA between countries  $i$  and  $j$  at time  $t$ . The representative unilateral export-promotion policy is captured by the continuous variable for export subsidies  $ES_{i,t}$ . The representative non-uniform trade policy corresponds to the continuous variable for MFN tariffs  $MFN_{j,t}$ . Both export-promotion and import-protection policies variables are interacted with the dummy variable  $INTL_{ij}$ , which is equal to one for *international* trade and zero for *intra-national* trade, in order to capture the fact that both types of policies apply only to international trade. Finally,  $\varepsilon_{j,t}$  is a stochastic error term that is assumed to not carry any systematic information about trade costs.<sup>11</sup>

For exposition simplicity, these different trade policy variables can be grouped in the vector  $\mathbf{T}_{j,t}$  and the associated parameters in the parameter vector  $\boldsymbol{\beta}$  :

$$X_{j,t} = \exp\left[\pi_{i,t} + \chi_{j,t} + \mu_{ij} + \mathbf{T}_{j,t}\boldsymbol{\beta}\right] \times \varepsilon_{j,t} \quad (2-27)$$

Once the structural gravity model (2-26) is estimated with the PPML estimator, the associated parameter estimates can be used, in combination with data on the corresponding covariates, to construct the matrix of baseline (*BLN*) trade costs:

$$\left[\hat{t}_{j,t}^{1-\hat{\sigma}}\right]^{BLN} = \exp\left[\hat{\mu}_{ij} + \mathbf{T}_{j,t}\hat{\boldsymbol{\beta}}\right] \quad (2-28)$$

As explained in Chapter 1, estimating the generic econometric gravity model (2-26) with data on tariffs can deliver directly an estimate of the trade elasticity of substitution,  $\hat{\sigma}$ , which represents the most important parameter for general equilibrium trade analysis (Arkolakis et al., 2012).

- (ii) **Calibration:** An alternative approach to obtain trade costs is to use a version of the so-called ratio approaches, which recover theory-consistent bilateral trade costs directly from the data by eliminating the country-specific structural terms. The advantage of the calibration approach is that, by construction, it delivers bilateral trade costs that match the trade data perfectly. The three leading trade cost calibration approaches proposed in the literature include:

1. The *odds-ratio method* (Head and Ries, 2001; Novy, 2013) consists of computing the ratio of *international* bilateral trade costs with respect to the *intra-national* trade costs between countries  $i$  and  $j$ :

$$\frac{t_{ij}t_{ji}}{t_{ii}t_{jj}} = \left( \frac{X_{ij}X_{ji}}{X_{ii}X_{jj}} \right)^{\frac{1}{1-\sigma}} \quad (2-29)$$

2. The *tetrads method* (Head et al., 2010; Romalis, 2007) computes a ratio of ratios by considering the trade flows of countries  $i$  and  $j$  with respect to two other reference countries: importer  $l$  and exporter  $k$ :

$$\frac{t_{ij}t_{lk}}{t_{jl}t_{ik}} = \left( \frac{X_{ij}X_{lk}}{X_{jl}X_{ik}} \right)^{\frac{1}{1-\sigma}} \quad (2-30)$$

3. The *three countries method* (Caliendo and Parro, 2015) specifies the relationship between relative trade costs and relative trade flows between three countries, namely  $i$ ,  $j$  and  $h$  without specifying any other reference country:

$$\frac{t_{ij}t_{jh}t_{hi}}{t_{ih}t_{hj}t_{ji}} = \left( \frac{X_{ij}X_{jh}X_{hi}}{X_{ih}X_{hj}X_{ji}} \right)^{\frac{1}{1-\sigma}} \quad (2-31)$$

The calibration approach is elegant and useful from a theoretical perspective. However, it may present a number of challenges for policy analysis. First, this approach is unable to identify the effects of specific trade policies. For example, the approach of calibrating trade costs can estimate the effects of a 10 percent decrease in trade costs, but cannot determine what kind of trade policy can lead to such a decrease. Thus, while elegant from a theoretical perspective, the calibration approach may not be very informative from a policy perspective. Another related disadvantage is that calibration cannot test the model specification and underlying hypotheses (Krugman, 2011; Dawkins et al., 2001). In other words, a calibration approach “assumes” an initial impact of trade policy instead of “testing” whether a specific trade policy actually resulted in a significant desired impact.

**(iii) “Estibration”:** Anderson et al. (2015b) propose a hybrid procedure to construct bilateral trade costs, which combines the most appealing features of the “estimation” and of the “calibration” approaches. Specifically, estimates of trade costs and trade elasticities can be first obtained from a properly specified empirical gravity equation, such as equation (2-26). Then baseline trade costs can be constructed by also taking into account the information contained in the error term:

$$\left[ \hat{t}_{j,t}^{1-\sigma} \right]^{BLN} = \exp \left[ \hat{\mu}_{ij} + \mathbf{T}_{j,t} \hat{\beta} \right] \times \hat{\varepsilon}_{j,t} \quad (2-32)$$

Equation (2-32) will deliver trade costs, which allow for a decomposition of the key trade cost components and enable to recover key elasticity parameters, while at the same time fitting the trade data perfectly by construction.

**Step 1.b (Optional): Recover additional parameters and exogenous variables.** This step computes the values of all the remaining parameters of the structural gravity model and the exogenous unobservable variables in order to ensure that the model is perfectly consistent with the data, not only at the bilateral trade level, as ensured in Step 1, but also at all levels in the baseline scenario. Applied to the baseline gravity system (2-1)-(2-5), this step will use the market-clearing conditions (2-4) to construct the set of CES preference parameters  $\alpha_i$  at the initial normalised factory-gate prices.

This step is labelled “optional” because, as demonstrated in Appendix C, the exact same solution to system (2-1)-(2-5) can be obtained when the gravity system is solved in levels or when it is solved in changes (Dekle et al., 2008). The difference between the two approaches is that solving the system in changes does not require values for some of the exogenous parameters (e.g. CES preference parameters), because these parameters cancel out since they remain constant in the baseline and in the counterfactual scenarios. It should be noted, however, that although solving the gravity system in levels requires computing additional parameters, it offers the advantage of being able to compare these additional parameters with corresponding values from the literature or, even better, directly with corresponding moments from actual data in order to validate the model (Krugman, 2011; Ottaviano, 2016).

**Step 1.c: Construct baseline indexes.** Using the values of the trade costs obtained in Step 1.a (and the values of the additional parameters from Step 1.b) the solution of the structural gravity system (2-2)-(2-5) delivers values of all indexes, such as consumer prices and multilateral resistances, which describe the baseline scenario in addition to actual (or fitted) data.

### **Step 2: Define a counterfactual scenario**

This second step entails defining the counterfactual experiment of interest. Given this *Advanced Guide’s* focus on trade policy, the counterfactual scenario involves the introduction or the removal of trade barriers, which will result in a change in bilateral trade costs. The definition of the trade policy variables for the counterfactual trade costs will depend on the policy question under investigation. For example, some popular scenarios include the introduction or elimination of a RTA, or reduction or increase in tariffs. Alternatively, the counterfactual scenario could imply a change in the trade cost elasticities ( $\hat{\beta}_1$ ,  $\hat{\beta}_2$ , and  $\hat{\beta}_3$ ). However, for expositional simplicity, only counterfactual scenarios where trade cost elasticities remain constant are considered here.

If, for instance, the objective is to assess the effects of a new bilateral trade agreement (e.g. between countries  $x$  and  $y$ ), the RTA dummy variable specified in the empirical gravity model (2-26) would have to be redefined to include this new agreement by replacing the zeros in the observations involving the country pair  $x$ - $y$  with ones. In addition, the applied preferential tariffs and/or other trade-related measures negotiated in the bilateral trade agreement that applied exclusively to country  $x$ ’s exports to country  $y$  and vice-versa should also be reflected in the empirical gravity specification. Overall, the structural gravity framework offers the flexibility to adjust all counterfactual policy variables in the vector  $\mathbf{T}_{ij,t}$  as needed to reflect the desired trade policy changes in the counterfactual scenario. Any adjustment to the trade policy

variables specified in the structural gravity model will result in a new matrix of counterfactual (CFL) bilateral trade costs:

$$\left[ \hat{t}_{j,t}^{1-\sigma} \right]^{CFL} = \exp \left[ \hat{\mu}_{ij} + \mathbf{T}_{j,t}^{CFL} \hat{\beta} \right] \quad (2-33)$$

The differences between the baseline trade costs defined in equation (2-28) (or (2-32)) and the counterfactual trade costs reported in equation (2-33) (or (2-33) adding the error term) is  $\varepsilon_{j,t}$ , the initial trade policy shock introduced in the general equilibrium system. As demonstrated below, this shock will translate into changes in the key economic indicators of interest to the policy maker, such as trade and real consumption.

### Step 3: Solve the counterfactual model

Using the values of the trade elasticities and the additional parameters obtained from Step 1, and the counterfactual trade costs from Step 2, the solution of the structural gravity system (2-2)-(2-5) in the counterfactual scenario will deliver the values for the indexes of interest. For instructional purposes, and consistent with the stepwise approach presented in the previous sub-section, the counterfactual indexes can be obtained by computing separately and sequentially the conditional general equilibrium effects and the full endowment general equilibrium effects.

**Step 3.a: Obtain “conditional general equilibrium” effects.** The conditional general equilibrium effects capture the total (direct plus indirect) effects of any changes in bilateral and/or non-discriminatory trade policy (i.e. any changes in  $t_{ij}$ ) on the trade costs of all countries in the world, for given output and expenditure. These conditional general equilibrium indexes are computed by solving the system of multilateral resistances (2-2)-(2-3) in order to obtain new values for the multilateral resistance terms ( $\Pi_i$  and  $P_j$ ), which, in turn, can be used together with data on actual output and expenditures to construct any indexes of interests at the conditional general equilibrium level.

**Step 3.b: Obtain “full endowment general equilibrium” effects.** The full endowment general equilibrium responses to the counterfactual trade policy changes capture the changes in factory-gate prices, resulting from the changes in the outward multilateral resistances, which lead to changes in the value of output and aggregate expenditures, which in turn impact directly trade and indirectly the multilateral resistances. The full endowment general equilibrium effects are computed by solving simultaneously the structural gravity system (2-1)-(2-5), which consists of  $5 \times N$  equations, in order to obtain the values for the outward and inward multilateral resistances ( $\Pi_i$  and  $P_j$ ), the factory-gate prices ( $p_i$ ), and the value of output ( $Y_i$ ) and aggregate expenditure ( $E_i$ ). Unlike the system of multilateral resistances (2-2)-(2-3) used to derive the conditional general equilibrium effects, the structural gravity system (2-1)-(2-5) is highly non-linear, even when the multilateral resistances are re-defined as power transforms, because of the functional form of the factory-gate prices in the market clearing conditions (2-4). The structural gravity system (2-1)-(2-5) can still be easily solved in any statistical software with matrix and non-linear optimization capabilities. As demonstrated below, it can also be solved in a loop with canned estimation and non-linear optimization commands directly in any standard statistical software packages, such as STATA software.



**Step 4: Collect, construct, and report indexes of interest**

After computing the conditional and/or full endowment general equilibrium effects trade cost indexes, the standard presentation consists of expressing the general equilibrium effects indexes in terms of percentage changes with respect to the baseline scenario:

$$\Delta\% \hat{\gamma}_{i,t} = \frac{\left( \hat{\gamma}_{i,t}^{CFL} - \hat{\gamma}_{i,t}^{BLN} \right)}{\hat{\gamma}_{i,t}^{BLN}} \times 100 \quad (2-34)$$

where  $\hat{\gamma}_{i,t}$  can be any index of interest and, as noted above, *BLN* and *CFL* stand for “baseline” and “counterfactual”, respectively.

**Step 5: Construct confidence intervals**

The last step of the general equilibrium analysis consists in constructing the confidence intervals of the general equilibrium indexes of interest computed in Step 4 in order to take into account the potential estimation error of the direct effects of trade policy obtained in Step 1. Despite its intuitive appeal and economic and policy significance, constructing confidence intervals for general equilibrium effects of trade policy is not as popular procedure as it should be in the trade literature.<sup>12</sup> Yet, constructing confidence intervals is a good practice for at least two reasons:

- (i) Confidence intervals will enable the researcher to gauge the significance of the general equilibrium effects of the trade policy in question.
- (ii) Confidence intervals can serve as uncertainty bounds offering a more conservative and a more liberal estimate of the expected trade policy effects.

Although constructing confidence intervals may be computationally intensive, there are different statistical approaches that are relatively straightforward to implement. One possible method is the bootstrap procedure of Anderson and Yotov (2016), who obtain a general equilibrium confidence interval in four steps:

**Step 5.a: Generate bootstrapped gravity estimates.** Generate *B* (e.g. 200) sets of bootstrapped gravity estimates according to Step 1.

**Step 5.b: Construct counterfactual trade costs.** Construct *B* corresponding sets of counterfactual bilateral trade costs as described in Step 2.

**Step 5.c: Compute general equilibrium trade costs.** Compute the general equilibrium effects and construct the *B* estimates of each of the general equilibrium trade costs indexes of interest following Step 3 and 4.

**Step 5.d: Construct the confidence interval.** Compute the 95 percent centred bootstrap confidence intervals of the *B* estimates of each index of interest as follows:

$$\left[ 2 \times \hat{\gamma}_{i,t} - \hat{\gamma}_{i,t}^{BOOT(97.5\% \times B)}; 2 \times \hat{\gamma}_{i,t} - \hat{\gamma}_{i,t}^{BOOT(2.5\% \times B)} \right] \quad (2-35)$$

where  $\hat{l}_{i,t}$  can be any index of interest obtained with the original estimates; and  $\hat{l}_{i,t}^{BOOT(2.5\% \times B)}$  and  $\hat{l}_{i,t}^{BOOT(97.5\% \times B)}$  are, respectively, the  $(2.5\% \times B)^{\text{th}}$  and the  $(97.5\% \times B)^{\text{th}}$  indexes from the ranked (from bottom to top) bootstrap sample  $(\hat{l}_{i,t}^{BOOT(1)}, \hat{l}_{i,t}^{BOOT(2)}, \dots, \hat{l}_{i,t}^{BOOT(B)})$ .

### 3. A general equilibrium gravity analysis with the Poisson Pseudo Maximum Likelihood (GEPPL)

While the previous section highlighted the main and standard steps required to perform general equilibrium gravity analysis, this section presents a procedure, developed by Anderson et al. (2015b), which builds on the properties of the PPML estimator to implement general equilibrium analysis with the structural gravity model in standard statistical software packages, such as STATA software. Specifically, in order to implement their methods, Anderson et al. (2015b) capitalize on a special additive property of the PPML estimator, as recently documented by Arvis and Shepherd (2013) and Fally (2015), which ensures a perfect match between the structural gravity terms and the corresponding directional (importer and exporter) fixed effects  $\pi_{i,t}$  and  $\chi_{j,t}$ :

$$\exp(\hat{\pi}_{i,t}) = \frac{Y_{i,t}}{\hat{\Pi}_{i,t}^{1-\sigma}} \times E_{R,t} \quad (2-36)$$

$$\exp(\hat{\chi}_{j,t}) = \frac{E_{j,t}}{\hat{P}_{j,t}^{1-\sigma}} \times \frac{1}{E_{R,t}} \quad (2-37)$$

where  $\hat{\pi}_{i,t}$  and  $\hat{\chi}_{j,t}$  are estimates of the directional fixed effects from a structural gravity estimation equation, such as equation (2-26),  $Y_{i,t}$  and  $E_{j,t}$  are the corresponding actual values of output and expenditure in year  $t$ ,  $\hat{\Pi}_{i,t}^{1-\sigma}$  and  $\hat{P}_{j,t}^{1-\sigma}$  are the corresponding calculated values of the multilateral resistance terms obtained by solving the system of equations (2-2) and (2-3), and  $E_{R,t}$  is the expenditure of the reference country  $R$  in year  $t$ .

The steps of the GEPPL procedure discussed below follow closely the stages of the standard approach to general equilibrium analysis with the structural gravity model.

#### *Step I: Solve the baseline gravity model*

Similar to the standard first stage, the first step of the approach requires obtaining estimates of the bilateral trade costs, including estimates of the elasticities of bilateral trade with respect to bilateral trade policy and constructing baseline gravity indexes of interest. The (optional) Step 1.b from the standard procedure above is not needed in the GEPPL procedure because, as demonstrated below, the gravity system will be solved through an iterative procedure that corresponds to the solution in changes from Dekle et al. (2007; 2008). Therefore, the procedure based on PPML eliminates the need to obtain explicit values for the CES share parameters.

*Step 1a: Obtain estimates of trade costs and trade elasticities baseline indexes.* An important feature of the GEPPML procedure presented here is that it can readily accommodate the three different approaches to treating bilateral trade costs and their elasticities in the existing literature that were described above:

- (i) **Estimation:** The generic econometric gravity model (2-26) can be estimated with the PPML estimator, using panel *intra-national* and *international* trade data with year intervals, and controlling for *exporter-time* fixed effects ( $\pi_{i,t}$ ), *importer-time* fixed effects ( $\chi_{j,t}$ ), and pair fixed effects ( $\mu_{ij}$ ):

$$\begin{aligned} X_{j,t} &= \exp\left[\pi_{i,t} + \chi_{j,t} + \mu_{ij} + \beta_1 RTA_{j,t} + \beta_2 ES_{i,t} \times INTL_{ij} + \beta_3 MFN_{j,t} \times INTL_{ij}\right] \times \varepsilon_{j,t} \\ &= \exp\left[\pi_{i,t} + \chi_{j,t} + \mu_{ij} + \mathbf{T}_{j,t} \boldsymbol{\beta}\right] \times \varepsilon_{j,t} \end{aligned} \quad (2-26)$$

In addition, any other linear or non-linear estimator can be employed to obtain the estimates of the trade cost elasticities  $\boldsymbol{\beta}$  in a preliminary step. In fact, the whole vector of bilateral trade costs and associated  $\boldsymbol{\beta}$  can even be borrowed from other studies as is routinely done in the literature. In case, the estimates of the trade cost elasticities are obtained externally, they have to be imposed as constraints in the PPML estimation of the gravity model (2-26).

As mentioned earlier, one of the advantages of the GEPPML approach is that it can be extended to recover out-of-sample trade costs even when trade data are missing. This is demonstrated in Box 3. Having the complete trade costs matrix is particularly important in order to obtain the full general equilibrium response to trade policy changes. The consequences of not having the complete trade costs matrix are magnified when data are missing for important players.

- (ii) **Calibration:** As discussed earlier, the whole trade cost vector can also be obtained externally by applying any of the ratio methods developed in the literature. The calibrated trade cost vector can then be used in the GEPPML procedure. In that case, the external trade cost vector should be imposed as a constraint in the PPML estimation of the gravity model (2-26), which automatically will adjust the corresponding exporter and importer fixed effects so that the resulting general equilibrium multilateral resistance terms correspond exactly to the calibrated trade cost vector.
- (iii) **“Estibration”:** Trade costs can also be obtained by applying the hybrid procedure proposed by Anderson et al. (2015b), which *estimates* the key elasticities of interest according to equation (2-26), while simultaneously matching the trade flows data perfectly (i.e. *calibrating*), by treating the error term,  $\varepsilon_{j,t}$ , from specification (2-26) as a component of the vector of trade costs. In that case, the PPML estimation should be carried out with the “estibrated” trade cost vector imposed as constraint.

Independently of how the gravity elasticities and the trade costs are obtained, the construction of the corresponding general equilibrium multilateral resistance indexes requires paying particular attention to the estimation and interpretation of the directional (importer and exporter) fixed effects of the structural gravity specification (2-26). Specifically, due to perfect collinearity, one of the directional fixed effects needs to be dropped in each year. In addition, as discussed earlier, a normalisation of the set of multilateral resistances  $P_j$  and  $\Pi_i$  is required to solve the system of

equations (2-2) and (2-3). In order to maintain consistency, the inward multilateral resistance for a representative country ( $R$ ) is normalized to one,  $P_{R,t} = 1$ , and the corresponding importer fixed effect,  $\chi_{R,t}$ , is removed from the specification (2-26). For interpretation ease, it is also recommended to estimate the econometric gravity model (2-26) without the constant term. This will ensure that the importer fixed effect of the reference country will be the only fixed effect that is dropped in the gravity estimation. Taking all of the above considerations into account, the interpretation of the dropped fixed effect in a given year is  $\chi_{R,t} = E_{R,t}$ , and all the other fixed effects in that year are estimated (and should be interpreted) relative to  $\chi_{R,t}$ .

**Step 1.b: Construct baseline indexes.** The PPML estimates of the importer-time fixed effects ( $\hat{\lambda}_{j,t}$ ) and of the exporter-time fixed effects ( $\hat{\pi}_{i,t}$ ) from the gravity model (2-26) can be combined with data on output ( $Y_{i,t}$ ) and expenditure ( $E_{j,t}$ ) to construct the baseline multilateral resistances  $[\hat{\Pi}_{i,t}^{1-\sigma}]^{BLN}$ , and  $[\hat{P}_{j,t}^{1-\sigma}]^{BLN}$ , according to equations (2-36) and (2-37), while taking into account the normalisation(s) imposed:

$$[\hat{\Pi}_{i,t}^{1-\sigma}]^{BLN} = \frac{Y_{i,t}}{\exp(\hat{\pi}_{i,t})} \times E_{R,t} \quad (2-38)$$

$$[\hat{P}_{j,t}^{1-\sigma}]^{BLN} = \frac{E_{j,t}}{\exp(\hat{\lambda}_{j,t})} \times \frac{1}{E_{R,t}} \quad (2-39)$$

where, by construction,  $Y_{i,t} = \sum_j X_{ij,t}$  and  $E_{j,t} = \sum_i X_{ij,t}$ . The baseline multilateral resistance terms can then be used to compute other baseline general equilibrium indexes of interest, such as the terms of trade formulated in equation (2-24) or the welfare/real consumption reported in equation (2-25).

### Box 3 Bilateral trade costs with missing trade flow data

One potential issue that may arise when trade flows data are missing or zero for a given pair over the whole period of investigation is the impossibility to identify and obtain the estimates of the complete set of fixed effects pairs, which are used to construct bilateral trade costs. A solution proposed by Anderson and Yotov (2016) consists of implementing a two-stage procedure:

*Step 1: Obtain the estimates of pair fixed effects from gravity model*

The first stage involves estimating the empirical gravity model in order to obtain the estimates of the bilateral fixed effects ( $\hat{\mu}_{ij}$ ) for country pairs with non-missing (or non-zero) trade flows:

$$X_{ij,t} = \exp[\pi_{i,t} + \chi_{j,t} + \mu_{ij} + \mathbf{T}_{ij,t}\boldsymbol{\beta}] \times \varepsilon_{ij,t}$$

(Continued)

**Box 3 (Continued)**

*Step 2: Regress the estimates of pair fixed effects on gravity variables and country-fixed effects*

The inclusion of the exporter and importer fixed effects in the above specification accounts for *intra*-national trade costs and it is required from gravity theory, which implies that only relative trade costs can be identified from an empirical gravity model. Consistent with this intuition, the estimates of the pair fixed effects from the first-stage estimation are obtained relative to *intra*-national trade costs. The estimates of the pair fixed effects ( $\hat{\mu}_{ij}$ ) obtained in the first stage are used as the dependent variable in a regression, where the covariates include the set of standard gravity variables along with importer and exporter fixed effects:

$$\exp[\hat{\mu}_{ij}] = \exp[\pi_i + \chi_j + \beta_1 \ln DIST_{ij} + \beta_2 CNTG_{ij} + \beta_3 LANG_{ij} + \beta_4 CLNY_{ij}] \times \varepsilon_{ij}$$

The (fitted) predicted bilateral trade costs from this second stage regression are computed,  $\hat{t}_{ij}^{1-\sigma} = \exp[\hat{\pi}_i + \hat{\chi}_j + \hat{\beta}_1 \ln DIST_{ij} + \hat{\beta}_2 CNTG_{ij} + \hat{\beta}_3 LANG_{ij} + \hat{\beta}_4 CLNY_{ij}]$ , and then used to fill up the missing trade costs values in order to construct the complete set of bilateral trade costs that can then be used in counterfactual analysis.

**Step II: Define a counterfactual scenario**

Similar to the standard second stage, the second step of the GEPPML approach requires defining the counterfactual experiment of interest by changing the definition of the policy variables in the vector  $\mathbf{T}_{j,t}^{CFL}$ , where *CFL* stands for counterfactual. As explained above, it is the differences between the baseline trade costs and the counterfactual trade costs that constitute the initial trade policy shock introduced in the general equilibrium system.

**Step III: Solve the counterfactual model**

Following the standard third stage presented above, the counterfactual model is solved in two steps by calculating separately and sequentially the conditional general equilibrium effects and the full endowment general equilibrium effects:

**Step III.a: Obtain conditional general equilibrium effects.** The conditional general equilibrium effects are constructed in two stages:

**(i) Estimate the “conditional” gravity model**

First, the gravity model (2-26) is re-estimated with the PPML estimator:

$$X_{j,t} = \exp[\pi_{i,t}^{CFL} + \chi_{j,t}^{CFL} + \bar{\mu}_{ij} + \mathbf{T}_{j,t}^{CFL} \bar{\boldsymbol{\beta}}] \times \varepsilon_{j,t}^{CFL} \quad (2-40)$$

where the symbol  $\bar{\phantom{x}}$  is used to capture the fact that certain coefficients of the gravity model are constrained to be equal to their baseline values.

(ii) **Construct “conditional general equilibrium” indexes**

The new PPML estimates of the fixed effects associated with the constrained structural gravity model can be used, in combination with the original data on output ( $Y_{i,t}$ ) and expenditure ( $E_{j,t}$ ), to construct the conditional general equilibrium values of the multilateral resistance taking into account the normalisation(s) imposed:

$$\left[ \hat{\Pi}_{i,t}^{1-\sigma} \right]_{CDL}^{CFL} = \frac{Y_{i,t}}{\exp(\hat{\pi}_{i,t}^{CFL})} \times E_{R,t} \quad (2-41)$$

$$\left[ \hat{P}_{j,t}^{1-\sigma} \right]_{CDL}^{CFL} = \frac{E_{j,t}}{\exp(\hat{\chi}_{j,t}^{CFL})} \times \frac{1}{E_{R,t}} \quad (2-42)$$

where *CDL* stands for “conditional”, and  $\hat{\pi}_{i,t}^{CFL}$  and  $\hat{\chi}_{j,t}^{CFL}$  are the PPML estimates of the exporter-time and import-time fixed effects of the constrained conditional gravity model (2-40), respectively. The counterfactual values of the bilateral trade costs and the multilateral resistances are sufficient (in combination with the original data on output and expenditure) to construct any other conditional general equilibrium indexes of interest.

**Step III.b: Obtain “full endowment general equilibrium” effects.** When the PPML estimator is used to estimate the structural gravity model, the full endowment general equilibrium effects can be computed with a four-step iterative procedure, as depicted in Figure 5. The iterative procedure presented below can be implemented in any standard statistical software, such as STATA software.

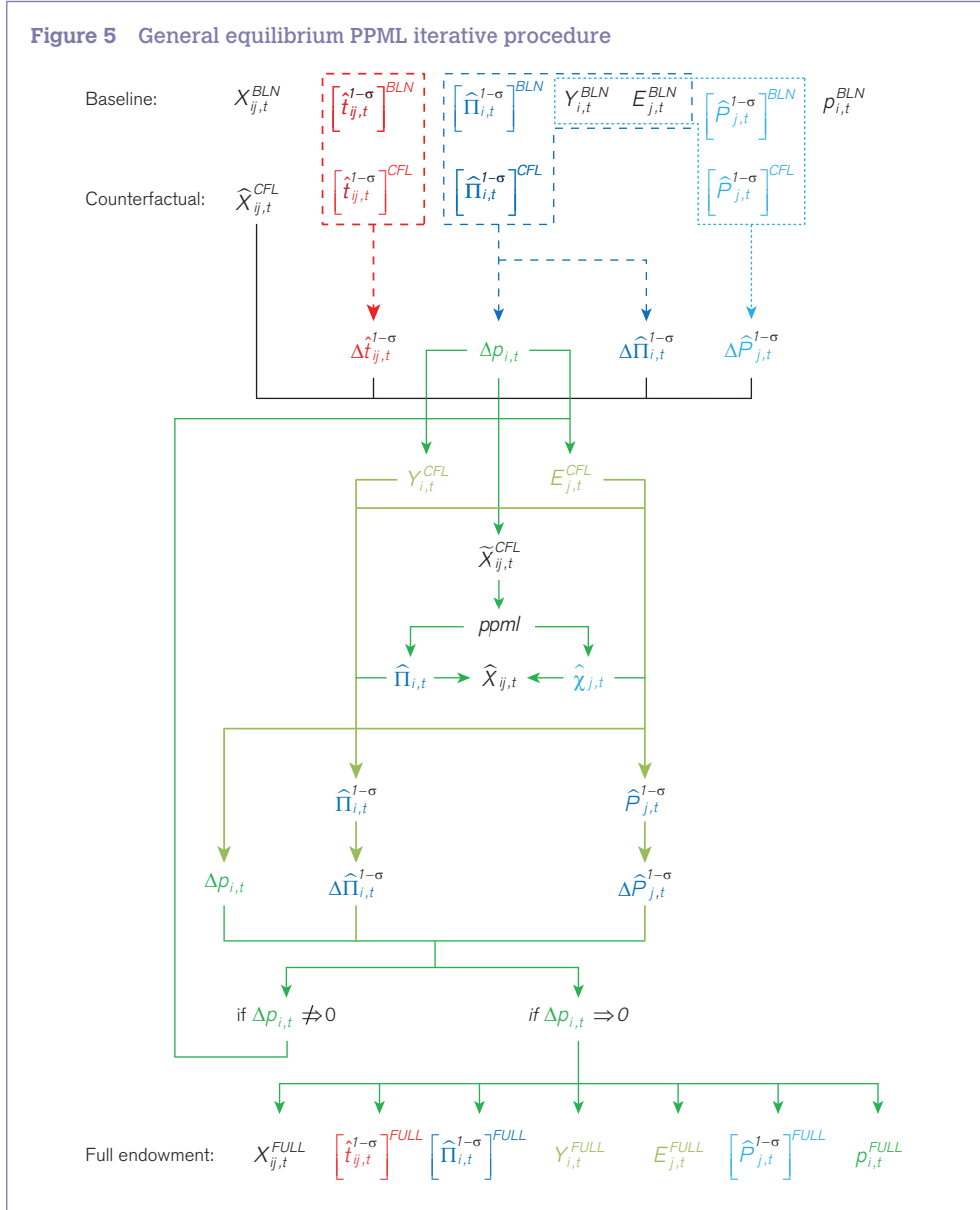
(i) **Allow for endogenous factory-gate prices**

The first stage of the loop requires using the market clearing conditions (2-4) to translate the conditional general equilibrium effects on the multilateral resistances terms obtained in Step III.a into *first-order* changes in factory-gate prices, by applying the definition of the estimated exporter fixed effects given in equation (2-41):<sup>13</sup>

$$\Delta p_{i,t}^{CFL} = \frac{p_{i,t}^{CFL}}{p_{i,t}} = \left( \frac{\exp(\hat{\pi}_{i,t}^{CFL}) / E_{R,t}^{CFL}}{\exp(\hat{\pi}_{i,t}) / E_{R,t}} \right)^{\frac{1}{1-\sigma}} \quad (2-43)$$

(ii) **Allow for endogenous income, expenditures and trade**

The second stage of the loop involves allowing for the endogenous response in the value of output/income  $Y_{i,t}^{CFL} = (p_{i,t}^{CFL} / p_{i,t}) Y_{i,t}$  and expenditure  $E_{j,t}^{CFL} = (p_{j,t}^{CFL} / p_{j,t}) E_{j,t}$ , which in turn will trigger additional changes in the multilateral resistance terms and so forth. Yet, the changes in output, expenditure and the multilateral resistances cannot be accounted for explicitly in the estimation of the structural gravity model, because they are controlled for by the fixed effects.



The solution is to use the structural gravity equation (2-1) to translate the changes in output and expenditure, triggered by the changes in factory-gate prices, into changes in trade flows:

$$X_{ij,t}^{CFL} = \frac{\left[ \hat{t}_{ij,t}^{1-\sigma} \right]^{CFL}}{\hat{t}_{ij,t}^{1-\sigma}} \times \frac{Y_{i,t}^{CFL} E_{j,t}^{CFL}}{Y_{i,t} E_{j,t}} \times \frac{\Pi_{i,t}^{1-\sigma}}{\left[ \hat{\Pi}_{i,t}^{1-\sigma} \right]^{CFL}} \times \frac{P_{j,t}^{1-\sigma}}{\left[ \hat{P}_{j,t}^{1-\sigma} \right]^{CFL}} \times X_{ij,t} \quad (2-44)$$

where the estimated bilateral trade costs in the baseline and counterfactual scenarios,  $\hat{t}_{j,t}^{1-\sigma}$  and  $[\hat{t}_{j,t}^{1-\sigma}]^{CFL}$ , are computed according to equations (2-28) and (2-33), respectively. Equation (2-44) accounts for the fact that a change in the factory-gate price will lead to changes in trade via several channels, namely changes in output and outward multilateral resistances on the exporter side, and changes in expenditure and inward multilateral resistances on the importer side. More importantly, the changes in trade implied by equation (2-44) are only *first-order* changes and do not reflect the full endowment general equilibrium changes, because they only capture the changes in the conditional outward multilateral resistances and the initial response in the factory-gate prices.

(iii) **Estimate the structural gravity model**

The third stage of the loop consists of repeating Step III.a by re-estimating the PPML gravity model (2-40) with the new value of bilateral trade  $X_{j,t}^{CFL}$  from equation (2-44), and then computing the corresponding general equilibrium effects associated with the new fixed effect estimates. The idea behind this step, and more generally behind the iterative procedure, is that by updating the value of trade, the PPML estimator will translate the initial response of factory-gate prices into changes in the gravity fixed effects, which (in combination with the changes in trade) can be used to obtain additional responses in the multilateral resistance terms and in the values of output and expenditure.

Once the set of fixed effects associated with the value of trade from equation (2-44) are estimated, the first stage of the iterative procedure has to be repeated in order to obtain a new set of factory-gate prices associated with these fixed effects. Similarly, the second stage of the loop has to be repeated to compute the new values of output, aggregate expenditures and trade. The structural gravity model (2-40) is then re-estimated with the new value of trade flows freshly computed by the previous step of the iterative procedure. These three steps are repeated until the change in each of the factory-gate prices is close to zero, that is when the structural gravity model has reached its new equilibrium.

(iv) **Construct “full endowment general equilibrium” indexes**

Once convergence is achieved, the latest set of fixed effects obtained can be used, in combination with the original and latest (full general equilibrium) data on output and expenditure, to construct the full endowment general equilibrium values of the multilateral resistance:

$$[\hat{\Pi}_{i,t}^{1-\sigma}]_{FULL}^{CFL} = \frac{Y_{i,t}^{FULL}}{\exp(\hat{\pi}_{i,t}^{FULL})} \times E_{R,t}^{FULL} \quad (2-45)$$

$$[\hat{P}_{j,t}^{1-\sigma}]_{FULL}^{CFL} = \frac{E_{j,t}^{FULL}}{\exp(\hat{\chi}_{j,t}^{FULL})} \times \frac{1}{E_{R,t}^{FULL}} \quad (2-46)$$

where *FULL* stands for “full endowment”, and  $\hat{\pi}_{i,t}^{FULL}$  and  $\hat{\chi}_{j,t}^{FULL}$  are the latest PPML estimates of the exporter-time and import-time fixed effects of the constrained structural gravity model, respectively, obtained by applying the iterative procedure, and  $Y_{i,t}^{FULL}$  and  $E_{j,t}^{FULL}$  are the corresponding output and expenditure values, which together with the other endogenous variables of the structural gravity model, can be easily computed as follows:



$$\frac{p_{i,t}^{FULL}}{p_{i,t}^{BLN}} = \left( \frac{\exp(\hat{\pi}_{i,t}^{FULL}) / E_{R,t}^{FULL}}{\exp(\hat{\pi}_{i,t}^{BLN}) / E_{R,t}^{BLN}} \right)^{\frac{1}{1-\sigma}} \quad (2-47)$$

$$Y_{i,t}^{FULL} = \frac{p_{i,t}^{FULL}}{p_{i,t}^{BLN}} \times Y_{i,t}^{BLN} \quad (2-48)$$

$$E_{i,t}^{FULL} = \varphi_i Y_{i,t}^{FULL} \quad (2-49)$$

$$X_{j,t}^{FULL} = \frac{Y_{i,t}^{FULL} E_{i,t}^{FULL}}{Y^{FULL}} \frac{(\hat{\pi}_{j,t}^{CFL})^{1-\sigma}}{[\hat{\Pi}_{i,t}^{1-\sigma}]_{FULL}^{CFL} [\hat{P}_{j,t}^{1-\sigma}]_{FULL}^{CFL}} \quad (2-50)$$

These full endowment general equilibrium indexes can then be used to compute other more refined general trade cost indexes, such as real GDP or real consumption.

#### **Step IV: Collect, construct, and report indexes of interest**

The differences, in percentage, between the baseline indexes from Step I and the counterfactual indexes from Step III.a measure the conditional general equilibrium effects of the simulated trade policy. The differences, in percentage, between the baseline indexes from Step I and the counterfactual indexes from Step III.b measure the full endowment general equilibrium effects of the simulated trade policy.

#### **Step V: Construct confidence intervals**

The general equilibrium PPML procedure described here naturally extends itself to the construction of confidence intervals as described in Step 5 of the standard procedure for counterfactual analysis with the gravity model.

## **C. Applications**

This section presents two applications that analyse the general equilibrium effects of two different trade policy experiments. The first hypothetical scenario removes all international borders in the world, while the second application simulates the effects of the North American Free Trade Agreement (NAFTA), negotiated by Canada, Mexico and the United States. The results of both applications, presented primarily for instructional purposes, are obtained by implementing the GEPPML procedure associated with the PPML estimator proposed by Anderson et al. (2015b) and presented in the previous section.

The data used in both applications are similar to the one employed in the applications presented in Chapter 1. The database reports bilateral trade, including *international* and *intra-national* trade, at the aggregated manufacturing level for 69 countries over the period 1986-2006. Information on RTAs and standard gravity variables such as distance, continuous borders, and common language,

are also included in the database. Section 3 of Chapter 1 provides details on the data sources used to construct the database.

## 1. Trade without borders

The first experiment investigates the effects of a hypothetical removal of all international borders, while preserving the effect of geography. This counterfactual scenario gives an idea of the potential effects of full trade integration where there are no differences for consumers and producers, apart from geographical differences, whether to buy or sell on national or international (i.e. across national borders) markets, respectively.

Although, as discussed in Chapter 1, proper identification of the effects of some gravity covariates (e.g. RTAs) requires panel data, most counterfactual experiments are performed with cross-section data. That is why, and in order to keep the analysis simple and tractable, the first application only employs cross-section data for the year 2006, which is the latest year in the sample. Specifically, the following econometric model is estimated with the PPML estimator in order to obtain point estimates of the effects of international borders, the variable of interest in this application:

$$X_{ij} = \exp\left[\pi_i + \chi_j + \beta_1 \ln DIST_{ij} + \beta_2 CNTG_{ij} + \beta_3 INTL_{ij}\right] \times \varepsilon_{ij} \quad (2-51)$$

where the bilateral trade costs  $t_{ij}^{1-\sigma}$  are approximated by the logarithm of bilateral distance ( $\ln DIST_{ij}$ ), an indicator variable for contiguity ( $CNTG_{ij}$ ), as well as an indicator variable for international borders ( $INTL_{ij}$ ) taking the value of one for international trade and zero otherwise. The exporter and importer fixed effects ( $\pi_i$  and  $\chi_j$ ), respectively, account for the multilateral resistances as well as for outputs and expenditures. The econometric gravity specification (2-51) is therefore consistent with the structural gravity system (2-1)-(2-5) presented in the previous section.

The treatment of international borders considered in this application through the variable  $INTL_{ij}$  offers two advantages but also two disadvantages, which should be kept in mind when interpreting the results. The border variable has the advantage of being, by construction, exogenous. The second advantage is that the border variable comprehensively captures the effects of all possible determinants of trade, in addition to geography, which is modelled explicitly, driving a wedge between internal and international trade. Conversely, the border variable assumes a common border effect across all pairs of countries in the sample, which has the drawback of ignoring the fact that border effects are quite heterogeneous across countries. This caveat is addressed in one of the exercises at the end of this chapter. The second caveat is that the model specification does not explicitly decompose the possible determinants of international borders, which implies that only hypothetical scenarios in terms of percentage decrease of international borders can be considered. As explained above, the hypothetical scenario of this application is the complete removal of all international borders. The analysis is performed in the STATA software by closely following the steps of the GEPPML procedure outlined in the previous section. The interested reader may refer to Larch and Yotov (2016a), who demonstrate that identical results are obtained by solving the general equilibrium gravity system with a non-linear solver, such as Matlab software.

### Step I: Solve the baseline gravity model

The first step of the GEPPML procedure delivers estimates of the trade costs and trade elasticities in the baseline scenario necessary to compute the baseline indexes of interest.

The first stage of this step consists of estimating the econometric gravity specification (2-51) in order to obtain the point estimates of the effects of distance, contiguity and international borders on international trade flows:

$$X_{ij} = \exp \left[ \hat{\pi}_i + \hat{\chi}_j - 0.791 \times \ln DIST_{ij} + \frac{0.674}{(0.107)} \times CNTG_{ij} - \frac{2.474}{(0.119)} \times INTL_{ij} \right] \times \hat{\varepsilon}_{ij} \quad (2-52)$$

For brevity, all coefficient estimates are reported directly in the estimating equation with standard errors in parentheses under the corresponding estimate. All PPML estimates are in accordance with prior expectations. The estimate of the coefficient of the distance variable is negative and highly statistically significant, and readily comparable to the corresponding median meta-analysis estimate of -0.89 reported by Head and Mayer (2014). The estimate of the impact of contiguity is positive, highly significant, and also close to the median summary index of 0.49 reported by Head and Mayer (2014). Finally, the estimates suggest that the effects of international borders are, on average, very large, even after controlling for geography (namely distance and contiguity). Specifically, the estimate of the coefficient on the variable  $INTL_{ij}$  implies that, all else equal, international borders decrease trade by an average of  $[\exp(\hat{\beta}_3) - 1] \times 100 = [\exp(-2.474) - 1] \times 100 = 91.6$  percent, whose associated standard error equal to 1.005 has been constructed with the delta method.

```
* STATA commands to estimate the baseline gravity model:
* Create variables for output and expenditure
bysort exporter: egen Y = sum(trade)
bysort importer: egen E = sum(trade)
* Define the country of reference (here Germany)
generate E_deuBLN = E if importer == "DEU"
      replace exporter = "ZZZ" if exporter == "DEU"
      replace importer = "ZZZ" if importer == "DEU"
egen E_deu = mean(E_deuBLN)

* Estimate the gravity model with the PPML estimator
describe IMPORTER_FE*
global N = r(r)
global N_1 = $N - 1
ppml trade EXPORTER_FE* IMPORTER_FE1-IMPORTER_FE$N_1 ln_DIST CNTG INTL, ///
      cluster(pair_id) noconstant
predict tradehat_BLN, mu
```

The second stage of the first step involves using the PPML estimates of the exporter and of the importer fixed effects from specification (2-52) in order to construct all the baseline values of the inward and outward multilateral resistances terms, which in turn can be used in combination with data on output and expenditure to obtain all other general equilibrium indexes of interest in the baseline.

These baseline values are not reported here for brevity. However, they will be used to calculate their changes in response to the counterfactual shock, i.e. the removal of international borders.

```
* STATA commands to obtain baseline trade costs:
* Construct the variables for export- and import-fixed effects
forvalues i = 1 (1) $N_1 {
    replace EXPORTER_FE`i' = EXPORTER_FE`i' * (exp(_b[EXPORTER_FE`i']))
    replace IMPORTER_FE`i' = IMPORTER_FE`i' * (exp(_b[IMPORTER_FE`i']))
}

replace EXPORTER_FE$N = EXPORTER_FE$N * exp(_b[EXPORTER_FE$N])
replace IMPORTER_FE$N = IMPORTER_FE$N * exp(0)
egen exp_pi_BLN = rowtotal(EXPORTER_FE1-EXPORTER_FE$N)
egen exp_chi_BLN = rowtotal(IMPORTER_FE1-IMPORTER_FE$N)

* Compute the variables of bilateral trade costs and multilateral resistances
generate tij_BLN = exp(_b[ln_DIST] * ln_DIST + _b[CNTG] * CNTG + _b[INTL] * INTL)
generate OMR_BLN = Y * E_deu / exp_pi_BLN
generate IMR_BLN = E / (exp_chi_BLN * E_deu)

* Compute the estimated international trade for given output and expenditures
generate tempXi_BLN = tradehat_BLN if exporter != importer
bysort exporter: egen Xi_BLN = sum(tempXi_BLN)
```

### Step II: Define a counterfactual scenario

The second step of the GEPPML procedure consists of defining the scenario that simulates the hypothetical removal of all international borders in the world. This can be achieved in different ways. One possibility is to simply eliminate the border variable from the construction of the counterfactual trade costs. Another possibility, useful for instructional purposes, is to define a new, counterfactual border variable that is equal to zero for each possible pair of countries in the sample.

```
* STATA commands to define counterfactual scenario of removing international borders
* Option 1: eliminate the border variable
generate tij_CFL = exp(_b[ln_DIST]*ln_DIST + _b[CNTG]*CNTG)

* Option 2: define a new counterfactual border variable
generate INTL_CFL = 0
generate tij_CFL = exp(_b[ln_DIST]*ln_DIST + _b[CNTG]*CNTG + _b[INTL]*INTL_CFL)

* Generate the logged trade costs used in the constraint
generate ln_tij_CFL = log(tij_CFL)
```

### Step III: Solve the counterfactual model

The third stage of the GEPPML procedure delivers the values of the counterfactual indexes of interest in the “conditional” and in the “full endowment” general equilibrium scenarios of abolishing international borders.

*Conditional general equilibrium effects.* Obtaining the “conditional general equilibrium” effects from the removal of international borders is achieved by re-estimating the econometric gravity specification (2-51) under a number of constraints to reflect the counterfactual scenario, namely there is no longer international border ( $\bar{\beta}_3 = 0$ ) but the effects of geography remain constant ( $\bar{\beta}_1 = -0.791$  and  $\bar{\beta}_2 = 0.674$ ):

$$X_{ij} = \exp\left[\pi_i^{CFL} + \chi_j^{CFL} - 0.791 \times \ln DIST_{ij} + 0.674 \times CNTG_{ij}\right] \times \varepsilon_{ij}^{CFL} \quad (2-53)$$

where the superscript *CFL* denotes the counterfactual values.

```
* STATA commands to estimate the conditional gravity model:
* Re-create a new set of exporter and importer fixed effects
drop EXPORTER_FE* IMPORTER_FE*
tabulate exporter, generate(EXPORTER_FE)
tabulate importer, generate(IMPORTER_FE)

* Estimate the constrained gravity model with the PPML estimator
ppml trade EXPORTER_FE* IMPORTER_FE1-IMPORTER_FE$N_1, cluster(pair_id) ///
    noconstant offset(ln_tij_CFL)
predict tradehat_CD, mu
```

The new set of estimates of fixed effects from specification (2-53) and the constrained coefficients of the trade cost variables are used to construct the corresponding “conditional general equilibrium” multilateral resistances, total exports, and real consumption for each of the 69 countries in the sample. As explained in the previous section, the multilateral resistance terms have to be normalized by setting the multilateral resistance terms of a given country, here Germany, equal to one.

```
* STATA commands to obtain conditional general equilibrium effects:
* Construct the variables for export- and import-fixed effects
forvalues i = 1 (1) $N_1 {
    replace EXPORTER_FE`i' = EXPORTER_FE`i' * (exp(_b[EXPORTER_FE`i']))
    replace IMPORTER_FE`i' = IMPORTER_FE`i' * (exp(_b[IMPORTER_FE`i']))
}
replace EXPORTER_FE$N = EXPORTER_FE$N * exp(_b[EXPORTER_FE$N])
replace IMPORTER_FE$N = IMPORTER_FE$N * exp(0)
egen exp_pi_CD = rowtotal(EXPORTER_FE1-EXPORTER_FE$N)
egen exp_chi_CD = rowtotal(IMPORTER_FE1-IMPORTER_FE$N)

* Compute the conditional general equilibrium effects of multilateral resistances
generate OMR_CD = Y * E_deu / exp_pi_CD
generate IMR_CD = E / (exp_chi_CD * E_deu)

* Compute the conditional general equilibrium effects of trade
generate tempXi_CD = tradehat_CD if exporter != importer
bysort exporter: egen Xi_CD = sum(tempXi_CD)
```

*Full endowment general equilibrium effects.* This step delivers the “full endowment general equilibrium” effects from the removal of international borders by implementing the four-stage iterative procedure that allows for endogenous factory-gate prices, income, expenditure and trade to adjust to the counterfactual shock.

```

* STATA commands to construct the iterative procedure to converge to full endowment
* general equilibrium effects:

    * Set the criteria of convergence
    local s = 3
    local sd_dif_change_p = 1
    local max_dif_change_p = 1
    while (`sd_dif_change_p' > 0.001) | (`max_dif_change_p' > 0.001) {
        local s_1 = `s' - 1
        local s_2 = `s' - 2
        local s_3 = `s' - 3

* i. Create the new dependent variable and estimate the gravity model with PPML
    generate trade_`s_1' = change_tij * tradehat_`s_2' * change_pricei_`s_2' * ///
        change_pricej_`s_2' / (change_OMR_FULL_`s_2' * change_IMR_FULL_`s_2')
    drop EXPORTER_FE* IMPORTER_FE*
    tabulate exporter, generate(EXPORTER_FE)
    tabulate importer, generate(IMPORTER_FE)
    capture ppml trade_`s_1' EXPORTER_FE* IMPORTER_FE1-IMPORTER_FE$N_1, ///
        cluster(pair_id) offset(ln_tij_CFL) noconstant iter(30)
    predict tradehat_`s_1', mu

* ii. Update output and expenditures
    bysort exporter: egen Y_`s_1' = total(tradehat_`s_1')
    generate tempE_`s_1' = phi * Y_`s_1' if exporter == importer
    bysort importer: egen E_`s_1' = mean(tempE_`s_1')
    generate tempE_deu_`s_1' = E_`s_1' if importer == "ZZZ"
    egen double E_deu_`s_1' = mean(tempE_deu_`s_1')

* iii. Update factory-gate prices and multilateral resistances
    forvalues i = 1 (1) $N {
        replace EXPORTER_FE`i' = EXPORTER_FE`i' * (exp(_b[EXPORTER_FE`i']))
        replace IMPORTER_FE`i' = IMPORTER_FE`i' * (exp(_b[IMPORTER_FE`i']))
    }
    egen exp_pi_`s_1' = rowtotal(EXPORTER_FE1-EXPORTER_FE$N)
    egen exp_chi_`s_1' = rowtotal(IMPORTER_FE1-IMPORTER_FE$N)
    generate tempvar1 = exp_pi_`s_1' if exporter == importer
    bysort importer: egen exp_pi_j_`s_1' = mean(tempvar1)
    generate change_pricei_`s_1' = ((exp_pi_`s_1' / exp_pi_`s_2') ///
        / (E_deu_`s_1' / E_deu_`s_2'))^(1/(1-sigma))
    generate change_pricej_`s_1' = ((exp_pi_j_`s_1' / exp_pi_j_`s_2') ///
        / (E_deu_`s_1' / E_deu_`s_2'))^(1/(1-sigma))
    generate OMR_FULL_`s_1' = (Y_`s_1' * E_deu_`s_1') / exp_pi_`s_1'
    generate change_OMR_FULL_`s_1' = OMR_FULL_`s_1' / OMR_FULL_`s_2'
    generate IMR_FULL_`s_1' = E_`s_1' / (exp_chi_`s_1' * E_deu_`s_1')
    generate change_IMR_FULL_`s_1' = IMR_FULL_`s_1' / IMR_FULL_`s_2'

* iv. Iterate until the change in factory-gate prices has converged to zero
    generate dif_change_p_`s_1' = change_pricei_`s_2' - change_pricei_`s_3'
    summarize dif_change_p_`s_1'
        local sd_dif_change_p = r(sd)
        local max_dif_change_p = abs(r(max))
    local s = `s' + 1
    drop temp*
}

```

As soon as the change in factory-gate price has converged to zero, all full endowment general equilibrium indexes of interest can be constructed as well.

```
* STATA commands to obtain full endowment general equilibrium effects:
* Define the last number of iterations
local S = `s' - 2

* Compute the full endowment general equilibrium of factory-gate price
generate change_pricei_FULL = ((exp_pi_`S'/exp_pi_0) ///
/ (E_deu_`S' / E_deu_0))^(1/(1-sigma))

* Compute the full endowment general equilibrium of output
generate Y_FULL = change_pricei_FULL * Y_BLN

* Compute the full endowment general equilibrium of aggregate expenditures
generate tempE_FULL = phi * Y_FULL if exporter == importer
bysort importer: egen E_FULL = mean(tempE_FULL)

* Compute the full endowment general equilibrium of the multilateral resistances
generate OMR_FULL = Y_FULL * E_deu_`S' / exp_pi_`S'
generate IMR_FULL = E_`S' / (exp_chi_BLN * E_deu)

* Compute the full endowment general equilibrium of trade
generate X_FULL = (Y_FULL * E_FULL * tij_CFL) / (IMR_FULL * OMR_FULL)
generate tempXi_FULL = X_FULL if exporter != importer
bysort exporter: egen Xi_FULL = sum(tempXi_FULL)
```

#### *Step IV: Collect, construct, and report indexes of interest*

Once the “conditional” and “full endowment” general equilibrium effects associated with the removal of international borders have been obtained, the changes, expressed in percentage, of the different indexes of interest between the baseline scenario and the “conditional” and “full endowment” scenarios can be computed.

```
* STATA commands to construct the percentage change of the general equilibrium indexes:
* Construct the percentage changes on export/production side
collapse(mean) OMR_BLN OMR_CDL OMR_FULL change_pricei_FULL Xi_BLN Xi_CDL ///
Xi_FULL Y_BLN Y_FULL, by(exporter)

* Change in full endowment general equilibrium factory-gate price
generate change_price_FULL = (change_pricei_FULL - 1) / 1 * 100

* Change in conditional and full general equilibrium outward multilateral resistances
generate change_OMR_CDL = (OMR_CD^(1/(1-sigma)) - OMR_BLN^(1/(1-sigma)))
/ OMR_BLN^(1/(1-sigma)) * 100
generate change_OMR_FULL = (OMR_FULL^(1/(1-sigma)) - OMR_BLN^(1/(1-sigma))) ///
/ OMR_BLN^(1/(1-sigma)) * 100

* Change in conditional and full general equilibrium international trade
generate change_Xi_CDL = (Xi_CDL - Xi_BLN) / Xi_BLN * 100
generate change_Xi_FULL = (Xi_FULL - Xi_BLN) / Xi_BLN * 100
```

Figure 6 and Figure 7 summarize the results of the application by plotting some of the key general equilibrium indexes simulating the uniform removal of world borders against the log of national GDP. The interested reader may refer to Larch and Yotov (2016a) for a more detailed presentation and discussion of the country-specific indexes.

Figure 6 depicts the change in the “conditional” and “full endowment” equilibrium exports in response to the removal of international borders for each country in the sample. The “conditional general equilibrium” effects on trade are particularly large and heterogeneous, which stem from the fact that the “direct/partial equilibrium” effect of international borders is also large ( $\hat{\beta}_3 = -2.474$ ). The significant increase in exports in the “conditional” scenario is further reinforced in the “full endowment” setting, whose effects vary between 41 and 91 percentage points as compared to the “conditional” scenario. The results of the application further suggest a strong positive correlation between the removal of international borders and country size, as measured by the value of output.

Figure 7 depicts the changes of real GDP associated with the removal of international borders and decomposes these changes into effects on the consumers (via the inward multilateral resistances defined as  $-1 \times P_{j,t}$ ) and on the producers (via the factory-gate prices) for each of the countries in the sample. Four main findings stand out.

First, the “full endowment” general equilibrium effects on real GDP are large. A comparison of these values with the corresponding indexes obtained by Costinot and Rodriguez-Clare (2014), who investigate a move from observed levels of trade to autarky, shows that the results are qualitatively similar for the same countries or comparable countries, suggesting that at this stage the world has enjoyed at most half of the possible gains from trade and trade liberalization and that there is significant scope for further gains from trade in the future.<sup>14</sup>

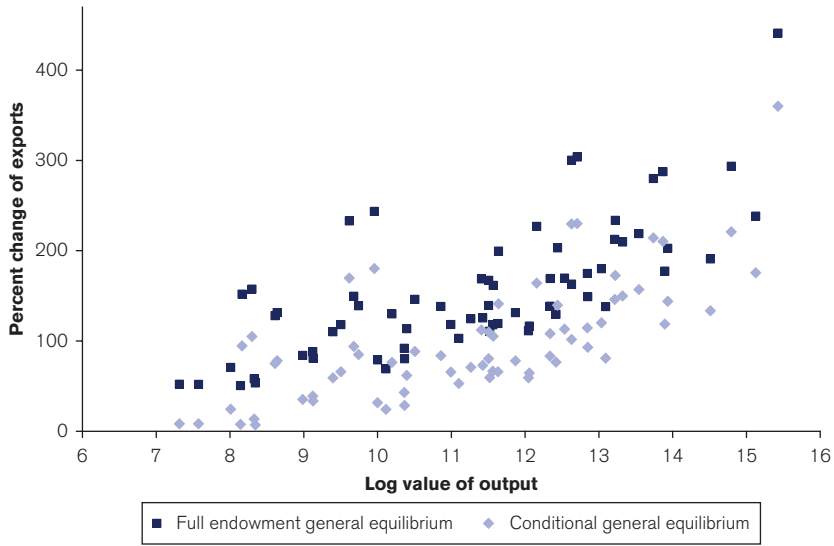
Second, the real GDP effects vary significantly across the countries in the sample. Specifically, the indexes suggest that less developed and smaller economies would benefit significantly more from the hypothetical uniform border removal as compared to developed and large countries. This result is in line with the intuition that the smaller of two countries gains more moving from autarky to free trade and that larger countries with a larger home market share gain less (Anderson et al., 2015b; Arkolakis et al., 2012).

Third, it is important to interpret this result together with the previous finding that it is actually the high income countries that would benefit more from the removal of borders in terms of exports. In combination, the two results imply that the real GDP gains for the low income countries would actually come mostly on the consumer side, through more favourable prices. This is captured in Figure 7, which shows that, indeed, the contribution of consumer prices to the real GDP change is the largest for low income countries. (The reader is reminded that all indexes on the producer and on the consumer side should be interpreted relative to the changes in consumer prices, inward multilateral resistances, in the reference country, Germany.)

Finally, the “full endowment” general equilibrium effects from the removal of the borders on producers (through changes in factory-gate price relative to Germany) appear to be larger than the “full endowment” general equilibrium effects on consumers. This result is consistent with the findings

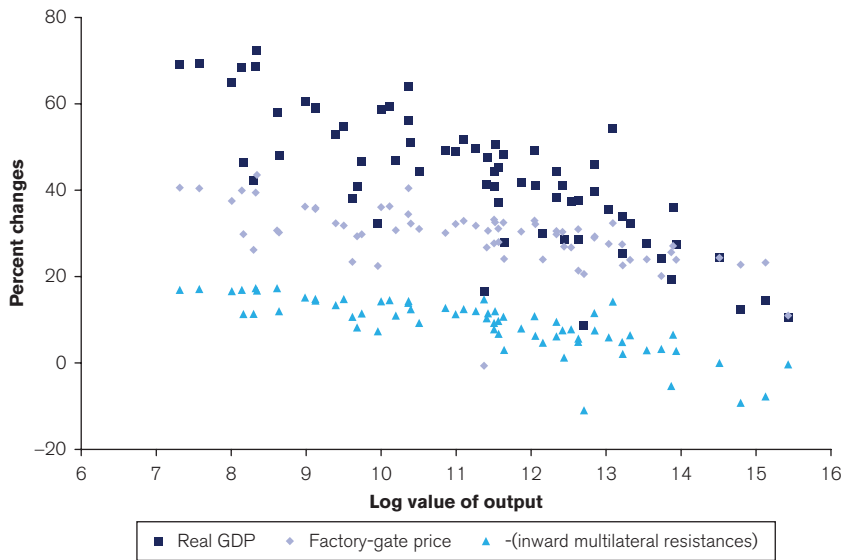


**Figure 6** Effects of abolishing international borders on exports



Source: Authors' calculations

**Figure 7** Effects of abolishing international borders on real GDP



Note: The inward multilateral resistances have been reformulated by multiplying their value by minus one.

Source: Authors' calculations

of Anderson and Yotov (2010b), who decompose the incidence of trade costs on the consumers and producers sides in Canada, and conclude that most of the gains from globalization accrue on the producer side.

## 2. Impact of regional trade agreements

The second experiment investigates the general equilibrium effects of regional trade agreements, in particular the effects of NAFTA. The choice of NAFTA is due to the fact that it is one of the most widely studied RTAs.<sup>15</sup> In addition to focusing on RTAs, whose effects have been a topic of significant policy interest, this application introduces three practical extensions that are valuable from an instructional perspective. First, unlike the previous application, this experiment takes advantage of the panel dimension of the dataset in order to identify the effects of RTAs and to comprehensively capture the impact of all time-invariant trade costs with the use of pair fixed effects. Second, the application implements the two-stage procedure of Anderson and Yotov (2016) to recover missing bilateral trade costs. Finally, the application demonstrates how the first stage of the GEPPML procedure can be implemented as a constrained regression with an external trade cost vector.

The analysis begins by specifying the following panel version of the empirical gravity model in order to obtain estimates of bilateral trade costs including an estimate of the average effects of all RTAs:

$$X_{j,t} = \exp[\pi_{i,t} + \chi_{j,t} + \mu_{ij} + \beta_1 RTA_{j,t}] \times \varepsilon_{ij,t} \quad (2-54)$$

where  $RTA_{j,t}$  is an indicator variable that is equal to one if two countries are members of the same RTA at time  $t$ , and zero otherwise. Following the best-practice recommendations formulated in Chapter 1, specification (2-54) is estimated with the PPML estimator using panel data with 4-year interval that include consistent *international* and *intra-national* trade flows, *exporter-time* fixed effects ( $\pi_{i,t}$ ) and *importer-time* fixed effects ( $\chi_{j,t}$ ). The *pair* fixed effects ( $\mu_{ij}$ ) are also included in order to alleviate potential endogeneity concerns of the RTA dummy variable and to control for all possible (observable and unobservable) time-invariant trade costs at the bilateral level. The GEPPML procedure outlined in the previous section is applied in the STATA software to evaluate the hypothetical scenario of removing NAFTA. Although not reported here, identical results are obtained by solving explicitly the general equilibrium gravity system with a non-linear solver, such as Matlab software (Larch and Yotov, 2016b).

### *Step I: Solve the baseline gravity model*

The first step of the GEPPML procedure requires estimating the baseline gravity model (2-54) in order to obtain point estimates of the effect of RTAs and the *pair* fixed effects and to construct the bilateral trade costs matrix required to compute the baseline indexes of interest. As discussed in Box 3, while it may be important to construct the complete matrix of bilateral trade costs in order to perform sound counterfactual analysis, it is often not possible to identify the

complete set of pair fixed effects estimates in the gravity model when trade flows data are missing (or zero) for a given pair throughout the whole period under investigation. Following Anderson and Yotov (2016), the two-stage procedure is implemented in order to recover the complete set of bilateral trade costs.

**Stage 1: Obtain the estimates of pair fixed effects and the effects of RTAs.** The first stage consists of estimating equation (2-54) in order to obtain the estimates of the bilateral fixed effects for country-pairs with non-missing (or non-zero) trade flows:

$$X_{ij,t} = \exp \left[ \hat{\pi}_{i,t} + \hat{\chi}_{j,t} + \hat{\mu}_{ij} + \frac{0.557}{(0.0506)} \times RTA_{ij,t} \right] \quad (2-55)$$

The estimate of  $\beta_1$  implies that, on average, the RTAs have led to about  $[\exp(\hat{\beta}_1) - 1] \times 100 = [\exp(0.557) - 1] \times 100 = 75$  percent increase in trade among members, whose associated standard error equal to 9.736 has been constructed with the delta method.

```
* STATA commands to obtain the estimates of pair fixed effects from gravity model:
ds PAIR_FE*
    global NT_ij = `: word count `r(varlist)''
    global NT_ij_1 = $NT - 1
    global NN_ij_8 = $NT - 8

ds EXPORTER_TIME_FE*
    global NT = `: word count `r(varlist)''

tabulate year, generate(TIME_FE)
ds TIME_FE*
    global Nyr = `: word count `r(varlist)''
    global NT_yr = $NT - $Nyr

ppml trade PAIR_FE1-PAIR_FE$NTij_1 EXPORTERTIME_FE* IMPORTER_TIME_FE1- ///
    IMPORTER_TIME_FE$NT_yr RTA, cluster(pair_id) noconst iter(30)
scalar RTA_est = _b[RTA]
```

**Stage 2: Regress the estimates of pair fixed effects on gravity variables and country fixed effects.** The second stage involves using the estimates of the pair fixed effects ( $\hat{\mu}_{ij}$ ) from equation (2-55) as the dependent variable in a regression where the covariates include the set of standard gravity variables along with importer and exporter fixed effects:

$$t_{ij}^{1-\sigma} = \exp(\hat{\mu}_{ij}) = \exp \left[ \pi_i + \chi_j + \beta_1 \ln DIST_{ij} + \beta_2 CNTG_{ij} + \beta_3 LANG_{ij} + \beta_3 COLONY_{ij} \right] \times \varepsilon_{ij} \quad (2-56)$$

The predictions from regression (2-56) are then used to fill in the missing trade cost values in order to obtain the complete set of bilateral trade costs  $\hat{\tau}_{ij}^{1-\sigma}$ .

```
* STATA commands to construct the full matrix of bilateral trade costs:
* Collect the estimates of the pair fixed effects
forvalues ijt = 1 (1) $NTij_8 {
    quietly replace PAIR_FE`ijt' = PAIR_FE`ijt' * _b[PAIR_FE`ijt']
}
egen gamma_ij = rowtotal(PAIR_FE1-PAIR_FE$NTij)
replace gamma_ij = . if gamma_ij == 1 & exporter != importer
replace gamma_ij = 0 if gamma_ij == 1 & exporter == importer
generate tij_bar = exp(gamma_ij)
generate tij_BLN = exp(gamma_ij + RTA_est * RTA)

* Replace missing trade costs with the predictions from the standard regression
keep if year == 1994
generate tij = exp(gamma_ij)
tabulate exporter, generate(EXPORTER_FE)
tabulate importer, generate(IMPORTER_FE)
ppml tij EXPORTER_FE* IMPORTER_FE* LN_DIST CNTG LANG CLNY ///
    if exporter!=importer, cluster(pair_id)
predict tij_noRTA, mu
replace tij_noRTA = 1 if exporter == importer
replace tij_bar = tij_noRTA if tij_bar == .
replace tij_BLN = tij_bar * exp(RTA_est * RTA) if tij_BLN == .
generate ln_tij_BLN = log(tij_BLN)
```

Once the full vector of bilateral trade costs is constructed, it can be imposed as a constraint in the baseline gravity specification (2-55), which will deliver estimates of the importer and of the exporter fixed effects that are consistent with this trade cost vector and can be used to directly recover the corresponding values of the multilateral resistances. It is worth noting that a similar constrained estimation procedure should be performed in general when the trade cost vector is obtained externally, including when it is constructed with a calibration method.

```
* STATA commands to solve the "constrained" baseline gravity model:
drop EXPORTER_FE* IMPORTER_FE*
tabulate exporter, generate(EXPORTER_FE)
tabulate importer, generate(IMPORTER_FE)
ppml trade EXPORTER_FE* IMPORTER_FE1-IMPORTER_FE$N_1, ///
    cluster(pair_id) offset(ln_tij_BLN) noconstant iter(30)
predict tradehat_BLN, mu
```

All other baseline indexes of interest can be obtained by applying the exact same procedure as described in the previous application.

### Step II: Define a counterfactual scenario

The second step of the GEPPML procedure requires defining the hypothetical removal of NAFTA. This is done by re-defining the RTA dummy variable,  $RTA_{ij,t}^{CFL}$ , as if NAFTA were not in place by setting the original RTA indicator variable to be equal to zero for trade between Canada, Mexico and the United States after 1993.<sup>16</sup>

```
* STATA commands to define counterfactual scenario of removal of NAFTA:
generate RTA_CFL = RTA
replace RTA_CFL = 0 if (exporter == "CAN" & importer == "USA") | ///
| (exporter == "CAN" & importer == "MEX") | ///
| (exporter == "MEX" & importer == "USA") | ///
| (exporter == "MEX" & importer == "CAN") | ///
| (exporter == "USA" & importer == "MEX") |
| (exporter == "USA" & importer == "CAN") & year > 1993
generate tij_CFL = tij_bar * exp(RTA_est * RTA_CFL)
generate ln_tij_CFL = log(tij_CFL)
```

### Step III: Solve the counterfactual model

The third stage of the GEPPML procedure consists of constructing the counterfactual indexes of interest in the “conditional” and in the “full endowment” general equilibrium scenarios of removing NAFTA. Despite the fact that the counterfactual considered in this experiment is totally different from the one considered in the previous application, the exact same procedure applies to first obtain the “conditional general equilibrium” effects and then compute the “full endowment general equilibrium” effects.

**Conditional general equilibrium effects.** The “conditional general equilibrium” effects from the removal of NAFTA are computed by re-estimating the econometric gravity specification (2-54) for 1994, the year of entry into force of NAFTA, subject to a number of constraints reflecting the counterfactual scenario:<sup>17</sup>

$$X_{ij} = \exp\left[\pi_i^{CFL} + \chi_j^{CFL} + \hat{t}_{ij}^{1-\sigma} + \hat{\beta}_1 RTA_{ij}^{CFL}\right] \times \varepsilon_{ij}^{CFL} \quad (2-57)$$

Equation (2-57) is estimated under the constraints that NAFTA was never concluded ( $RTA_{ij}^{CFL}$ ) and the coefficient of the  $RTA$  dummy as well as the bilateral fixed effects are equal to their baseline values,  $\hat{\beta}_1$  and  $\hat{t}_{ij}^{1-\sigma}$ , respectively, ensuring that no part of the trade costs besides the  $RTA$  dummy is changing. The PPML estimates of the directional fixed effects from equation (2-57) can then be used to recover the conditional multilateral resistance indexes  $\hat{\Pi}_i^{CFL}$  and  $\hat{P}_j^{CFL}$  subject to normalisation (with Germany chosen as reference country).

*Full endowment general equilibrium effects.* The values of the “full endowment general equilibrium” effects of the removal of NAFTA are directly obtained by implementing the iterative procedure, outlined in the previous section, which sequentially allows for endogenous factory-gate prices, followed by income, expenditure and trade to adjust to the counterfactual shock.

#### *Step IV: Collect, construct, and report indexes of interest*

Table 4 reports the results of the counterfactual analysis, including the percentage difference between the baseline values and their “full endowment” counterparts of the main variables of interest for each country in the sample. As reported in column (1) of Table 4, the results of the application suggest that all the members of NAFTA experience a significant direct increase in exports due to the trade agreement, ranging from 19 to 57 percent of their respective total exports. By construction, countries that did not conclude NAFTA are not subject to any direct/partial equilibrium effects.

Column (2) of Table 4 reveals that, under the conditional general equilibrium scenario, the member countries of NAFTA experience the largest increase in exports, ranging from 15 to 42 percent of their respective total exports. These “conditional” effects are significantly smaller than the “direct/partial” effects because of trade diversion. Part of the increase in trade with member countries comes at the expense of trade with non-members. Trade diversion explains also why the “conditional general equilibrium” effects on non-NAFTA countries’ exports are negative, albeit small (less than 1 percent for the vast majority of countries). Non-member countries facing the largest “conditional” decrease in exports (amounting to less than 2 percent) appear to be geographically close to the three economies, while the countries experiencing the smallest “conditional” effect tend to be countries with weak trade ties.

As highlighted in column (3) of Table 4, the values of the “full endowment” general equilibrium effects of NAFTA on exports are qualitatively identical to the corresponding “conditional” equilibrium effects, even though there are a number of quantitative differences. First, the “full endowment” general equilibrium effects on NAFTA’s members are slightly larger suggesting that part of the decrease in bilateral trade costs due to the creation of NAFTA translates into additional gains for the producers in the member countries who enjoy higher producer prices. In most cases, the increase in the size of NAFTA members mitigates the negative effects on non-members’ exports. As reported in column (4) of Table 4, the counterfactual analysis further suggests that the “full endowment” welfare effects of NAFTA are positive for its members, ranging between 0.3 and 3.8 percent, and slightly negative or null for non-member countries.<sup>18</sup>

The decomposition of the “full endowment” general equilibrium effects reported, respectively, in column (5), (6) and (7) suggests that both consumers and producers in member countries of NAFTA face positive effects with lower inward multilateral resistances (for consumers) and lower outward multilateral resistances, which translate into higher factory-gate prices (for producers) relative to the effects on the consumers in the reference country, here Germany. Conversely, producers in many non-member countries experience negative “full endowment” general equilibrium effects because of lower producer prices, while consumers in some non-member countries enjoy lower prices. This positive effect could be driven by the decrease of producer prices in many non-member countries and/or by improvements in efficiency in NAFTA member countries. Overall, despite some specification and data limitations, the results presented and discussed above are comparable with findings from existing related studies.

**Table 4** General equilibrium effects of NAFTA

Country	(1)	(2)	(3)	(4)	(5)	(6)	(7)
	<i>Partial effect</i>	<i>Conditional GE</i>	<i>Full Endowment General Equilibrium</i>				
	% $\Delta$ exports	% exports	% $\Delta$ exports	% $\Delta$ real GDP	% $\Delta$ IMRs	% $\Delta$ OMRs	% $\Delta$ price
ARG	0.00	-0.66	-0.69	0.00	0.01	-0.01	0.00
AUS	0.00	-0.49	-0.51	0.01	0.02	-0.01	-0.01
AUT	0.00	-0.07	-0.10	-0.01	0.00	-0.01	0.01
BEL	0.00	-0.09	-0.12	0.00	0.00	0.00	0.00
BGR	0.00	-0.05	-0.07	0.00	0.00	0.00	0.00
BOL	0.00	-0.47	-0.48	0.01	0.03	-0.02	-0.01
BRA	0.00	-0.65	-0.69	-0.02	-0.01	-0.01	0.02
CAN	55.05	34.99	37.46	1.84	-1.48	3.40	-2.14
CHE	0.00	-0.14	-0.17	-0.01	0.00	-0.01	0.01
CHL	0.00	-0.81	-0.83	-0.03	0.01	-0.03	0.03
CHN	0.00	-0.34	-0.38	-0.02	-0.01	-0.01	0.03
CMR	0.00	-0.13	-0.16	0.00	0.01	-0.01	0.00
COL	0.00	-1.80	-1.73	0.06	0.09	-0.03	-0.07
CRI	0.00	-1.03	-1.04	-0.01	0.06	-0.07	0.01
CYP	0.00	-0.09	-0.11	0.01	0.01	0.00	-0.01
DEU	0.00	-0.14	-0.17	-0.01	0.00	-0.01	0.01
DNK	0.00	-0.06	-0.09	-0.01	0.00	-0.01	0.01
ECU	0.00	-0.93	-0.89	0.05	0.08	-0.02	-0.06
EGY	0.00	-0.31	-0.33	0.01	0.02	-0.01	-0.02
ESP	0.00	-0.13	-0.15	-0.01	0.00	-0.01	0.01
FIN	0.00	-0.09	-0.11	-0.01	0.00	-0.01	0.01
FRA	0.00	-0.13	-0.15	0.00	0.00	-0.01	0.01
GBR	0.00	-0.23	-0.25	0.00	0.01	-0.01	0.01
GRC	0.00	-0.08	-0.11	0.00	0.01	0.00	0.00
HKG	0.00	-0.20	-0.23	-0.01	0.01	-0.02	0.01
HUN	0.00	-0.04	-0.07	0.00	0.00	0.00	0.01
IDN	0.00	-0.19	-0.24	-0.01	0.00	-0.01	0.01
IND	0.00	-0.30	-0.33	0.00	0.01	-0.01	0.00
IRL	0.00	-0.10	-0.13	-0.02	0.01	-0.03	0.02
IRN	0.00	-0.13	-0.16	0.01	0.01	0.00	-0.01
ISL	0.00	-0.23	-0.25	0.01	0.02	-0.01	-0.01
ISR	0.00	-0.38	-0.41	0.00	0.02	-0.02	0.00
ITA	0.00	-0.12	-0.15	-0.01	0.00	-0.01	0.01
JOR	0.00	-0.28	-0.30	0.02	0.02	0.00	-0.02
JPN	0.00	-0.35	-0.42	-0.03	-0.02	-0.01	0.03
KEN	0.00	-0.22	-0.24	0.02	0.02	0.00	-0.02
KOR	0.00	-0.41	-0.45	-0.02	-0.01	-0.02	0.03
KWT	0.00	-0.23	-0.26	0.00	0.01	-0.01	0.00
LKA	0.00	-0.30	-0.33	0.00	0.02	-0.01	-0.01
MAC	0.00	-0.21	-0.24	-0.02	0.02	-0.05	0.03
MAR	0.00	-0.08	-0.10	0.00	0.00	0.00	0.00
MEX	56.65	41.64	43.51	1.30	-2.40	3.81	-1.52
MLT	0.00	-0.13	-0.15	-0.01	0.01	-0.02	0.01
MMR	0.00	-0.13	-0.18	0.01	0.01	0.00	-0.01
MUS	0.00	-0.06	-0.09	0.00	0.01	-0.01	0.00
MWI	0.00	-0.18	-0.19	0.01	0.02	-0.01	-0.01
MYS	0.00	-0.22	-0.27	-0.02	0.01	-0.03	0.03
NER	0.00	-0.11	-0.13	-0.01	0.02	-0.02	0.01
NGA	0.00	-0.37	-0.39	0.02	0.03	0.00	-0.03

*(Continued)*

**Table 4 (Continued)**

Country	(1)	(2)	(3)	(4)	(5)	(6)	(7)
	<i>Partial effect</i>	<i>Conditional GE</i>	<i>Full Endowment General Equilibrium</i>				
	% $\Delta$ exports	% exports	% $\Delta$ exports	% $\Delta$ real GDP	% $\Delta$ IMRs	% $\Delta$ OMRs	% $\Delta$ price
NLD	0.00	-0.07	-0.09	-0.01	0.00	-0.01	0.01
NOR	0.00	-0.24	-0.25	0.00	0.02	-0.01	0.00
NPL	0.00	-0.22	-0.25	0.01	0.02	-0.01	-0.01
PAN	0.00	-0.60	-0.62	0.00	0.03	-0.02	0.00
PHL	0.00	-0.29	-0.33	-0.02	0.01	-0.03	0.02
POL	0.00	-0.05	-0.07	0.00	0.00	0.00	0.00
PRT	0.00	-0.06	-0.08	0.00	0.00	0.00	0.00
QAT	0.00	-0.19	-0.22	-0.01	0.01	-0.01	0.01
ROM	0.00	-0.08	-0.10	0.00	0.00	0.00	0.00
SEN	0.00	-0.08	-0.10	0.01	0.01	0.00	-0.01
SGP	0.00	-0.15	-0.19	-0.02	0.01	-0.03	0.02
SWE	0.00	-0.11	-0.13	-0.01	0.00	-0.01	0.01
THA	0.00	-0.25	-0.29	-0.01	0.00	-0.01	0.02
TTO	0.00	-0.86	-0.88	-0.06	0.02	-0.08	0.07
TUN	0.00	-0.04	-0.07	0.00	0.00	0.00	0.00
TUR	0.00	-0.14	-0.16	0.00	0.00	0.00	0.00
TZA	0.00	-0.16	-0.17	0.01	0.02	-0.01	-0.01
URY	0.00	-0.42	-0.44	-0.01	0.01	-0.02	0.01
USA	18.33	14.48	14.88	0.15	-0.18	0.33	-0.17
ZAF	0.00	-0.31	-0.34	0.00	0.01	-0.01	0.00

Source: Authors' calculations

Notes: This table reports results of NAFTA counterfactual analysis. Column (1) reports the average partial equilibrium percentage changes in total exports of a country. The conditional general equilibrium (GE) scenario, reported in column (2) takes the direct and indirect trade cost changes into account but holds GDPs constant. The full endowment GE scenario, reported in columns (3) to (7), additionally takes general equilibrium income effects into account. In particular, column (3) reports the average percentage changes in total exports of a country, column (4) the average percentage changes in real GDP (which may be taken as a welfare measure), column (5) reports the average percentage changes in the inward multilateral resistances (IMRs), and column (6) the corresponding average outward multilateral resistances (OMRs). The last column, column (7), reports the average changes in producer prices. See text for further details.

## D. Exercises

### 1. Calculating the general equilibrium impacts of removing a specific border

The aim of this exercise is to assess the general equilibrium impacts of the border between two countries of the reader's choice (e.g. countries A and B) within the framework developed in the chapter. This border removal scenario is hypothetical, especially given that the partial equilibrium border estimates obtained most probably capture more than just impediments to trade, such as preferences.

- (i) Select two countries (A and B) available in the sample of the data file "Chapter2Exercise1.dta", which share a common border and assume that the "direct/partial equilibrium" effect of the border between country A and country B is equal to the average border effect in the world. Use



and modify the STATA do-file associated with Application 1 on trade without borders in order to simulate the removal of the border between country A and country B **only**, while preserving all other borders in the world in place. Discuss the results in terms of effects on trade, real GDP, and effects on consumers and producers in each country.

*Hint: Only the definition of the counterfactual scenario in Step II needs to be changed.*

- (ii) Given the specific relationship between countries A and B, one may expect that the border between these two nations would be smaller or larger than the average border in the world. Modify the STATA code from part (1) in order to allow for a differential partial border effect between country A and country B. Are the expectations for a lower or larger border between countries A and B confirmed? What are the volume effects of the border?

*Hint: The gravity model should be re-estimated with a new border variable for countries A and B.*

- (iii) Use the new border estimates from part (2) to obtain the general equilibrium effects of the removal of the border between countries A and B. Discuss the results and compare them with those from part (1).

*Hint: Change the definition of the counterfactual scenario in Step II.*

- (iv) Some politicians believe that their country will benefit more if trading partners remove the impediments for this country's exports, while the country in question preserves its borders on imports from abroad. Use the partial estimates from part (2) to simulate a unilateral removal of the border for exports from country A to country B. Discuss the results relative to the estimates from part (3).

*Hint: Change the definition of the counterfactual scenario in Step II.*

## 2. Calculating the general equilibrium impacts of a regional trade agreement

The aim of this exercise is to re-assess the general equilibrium impact on trade of the formation of NAFTA. Unlike the Application 2 presented in the previous section, the assumption that the partial effects of an individual RTA are equal to the average effect of all RTAs entered into force in the sample during the period of investigation is removed. As a deep RTA with many provisions, NAFTA's effects were likely to be stronger than those of most other RTAs.

- (i) Following the above intuition, use and modify the STATA do-file associated with Application 2 in order to allow for specific partial effects of NAFTA. Did the results confirm the expectations for stronger effects for NAFTA as compared to the effects of all other RTAs?

*Hint: The gravity model should be re-estimated with a separate RTA dummy for NAFTA.*

- (ii) Use the NAFTA-specific estimates from part (1) to obtain general equilibrium effects of NAFTA. Discuss the results and compare them with the main estimates from Application 2.

*Hint: Change the definition of the counterfactual scenario in Step II.*

- (iii) Use and modify the STATA do-file in order to obtain the estimates from Application 2 to *ex ante* simulate the effects of a potential RTA of your choice by focusing on the last year in the sample.

*Hint: Repeat steps (i) and (ii) above to obtain results for the agreement of your choice.*

## Appendices

### Appendix A: Counterfactual analysis using supply-side gravity framework

In the demand-side model, the assumption of an endowment economy implies that the model can be closed by using the market clearing condition. Assuming an endowment economy is at odds with the supply side in the supply-side framework. However, it is still possible to close the model in a simple way for counterfactual analysis. Specifically, firms are assumed to produce a final good with one unit of the single production factor labour, i.e.  $\varsigma_i = w_i$ .

Under this assumption, equation (1.A.8) of the structural gravity from the supply side (Eaton and Kortum, 2002) derived in Appendix A of Chapter 1 can be rewritten as:

$$T_i w_i^{-\theta} = \frac{Y_i}{\sum_{j=1}^N \frac{t_{ij}^{-\theta}}{\Phi_j} E_j} = \frac{\frac{Y_i}{Y}}{\sum_{j=1}^N \gamma^{-\theta} \left( \frac{t_{ij}}{P_j} \right)^{-\theta} \frac{E_j}{Y}} = \gamma^\theta \frac{Y_i}{Y} \Pi_i^\theta \quad (2.A.1)$$

Solving equation (2.A.1) for wages  $w_i$  yields:

$$w_i = \gamma^{-1} T_i^{\frac{1}{\theta}} \left( \frac{Y_i}{Y} \right)^{-\frac{1}{\theta}} \Pi_i^{-1} \quad (2.A.2)$$

Equation (2.A.2) replaces the expression for  $p_i$  in equation (2-4) in the structural gravity system derived from the demand side.

As labour is the only factor of production, equation (2-5) in the system derived from the demand side is replaced by:

$$Y_i = w_i L_i \quad (2.A.3)$$

Similar to the general equilibrium analysis in the demand-side model, counterfactuals are established under the assumption of exogenous trade imbalances, i.e.  $E_i = \phi_i Y_i$ , where  $\phi_i > 1$  denotes a trade deficit in country  $i$ , and  $0 < \phi_i < 1$  captures a trade surplus in country  $i$ .

Hence, the general equilibrium analysis using the structural gravity system derived from the supply side is given by:

$$X_{ij} = \frac{Y_i E_j}{Y} \left( \frac{t_{ij}}{\Pi_i P_j} \right)^{-\theta} \quad (2.A.4)$$

$$P_j^{-\theta} = \sum_{i=1}^N \left( \frac{t_{ij}}{\Pi_i} \right)^{-\theta} \frac{Y_i}{Y} \quad (2.A.5)$$

$$\Pi_i^{-\theta} = \sum_{j=1}^N \left( \frac{t_{ij}}{P_j} \right)^{-\theta} \frac{E_j}{Y} \quad (2.A.6)$$

$$w_i = \left( \frac{Y_i}{Y} \right)^{-\frac{1}{\theta}} \frac{T_i^{\frac{1}{\theta}}}{\gamma \Pi_i} \quad (2.A.7)$$

$$Y_i = w_i L_i \quad (2.A.8)$$

$$E_i = \varphi_i Y_i \quad (2.A.9)$$

It follows that the counterfactual change in total output can be computed as:

$$\frac{Y_i^{CFL}}{Y_i^{BLN}} = \frac{w_i^{CFL}}{w_i^{BLN}} = \frac{\gamma T_i^{\frac{1}{\theta}} \left( \frac{Y_i^{CFL}}{Y^{CFL}} \right)^{-\frac{1}{\theta}} (\Pi_i^{CFL})^{-1}}{\gamma T_i^{\frac{1}{\theta}} \left( \frac{Y_i^{BLN}}{Y^{BLN}} \right)^{-\frac{1}{\theta}} (\Pi_i^{BLN})^{-1}} = \frac{\left( \frac{Y_i^{CFL}}{Y^{CFL}} \right)^{-\frac{1}{\theta}} (\Pi_i^{CFL})^{-1}}{\left( \frac{Y_i^{BLN}}{Y^{BLN}} \right)^{-\frac{1}{\theta}} (\Pi_i^{BLN})^{-1}} \quad (2.A.10)$$

where the superscript *BLN* and *CFL* denotes the value in the baseline and counterfactual scenario, respectively.

## Appendix B: Structural gravity with sectors

The objectives of this appendix are to demonstrate how the aggregate structural gravity model can be extended to the sectoral level, to compare the aggregate and the sectoral gravity system, to discuss implications of moving to the sectoral level, and to present and compare two sectoral versions of the structural gravity model; one on the demand side and one on the supply side. The derivation of the gravity on the demand side follows Larch and Wanner (2014) and Anderson and Yotov (2016), while the derivation of the gravity system on the supply side is based on Eaton and Kortum (2002). The interested reader may also refer to Costinot et al. (2012), Caliendo and Parro (2015) and Donaldson (2016).

### Sectoral gravity on the demand side

Sectoral gravity on the demand side is obtained by extending the standard assumptions from Anderson (1979) to accommodate sectors. Specifically, the model considers many ( $K$ ) goods, where, within each good's class  $k \in K$ , varieties are differentiated by place of origin as before. Similarly to the aggregate setting from the main analysis, the economy is defined in an endowment setting, but this time at the sectoral level:

$$Y_i^k = p_i^k Q_i^k \quad (2.B.1)$$

where,  $Q_i^k$  is the endowment of goods in class  $k$  in country  $i$ ;  $p_i^k$  is the corresponding factory-gate price, and  $Y_i^k$  is the sectoral income in country  $i$ . Finally, on the demand side, consumer preferences within each class of goods are assumed to be based on a constant elasticity of substitution (CES), as in the main analysis. However, this time the CES preferences across varieties within each class of goods are nested in a Cobb-Douglas utility function that reflects preference across different goods classes. As a result, for each country, the expenditure in each class of goods,  $E_i^k$ , is obtained as a constant share  $\eta^k$  of this country's total expenditure  $E_i$ :

$$E_i^k = \eta^k E_i = \eta^k \phi_i Y_i \quad (2.B.2)$$

where, as in the main analysis, the rightmost equality reflects the fact that national trade imbalances vary exogenously ( $\phi_i \neq 1$ ). Solving the consumer optimization problem and imposing market clearing at delivered prices for each sector obtains the demand-side structural gravity system:

$$X_{ij}^k = \frac{Y_i^k E_j^k}{Y^k} \left( \frac{t_{ij}^k}{\Pi_i^k P_j^k} \right)^{1-\sigma_k} \quad (2.B.3)$$

$$(\Pi_i^k)^{1-\sigma_k} = \sum_j \left( \frac{t_{ij}^k}{P_j^k} \right)^{1-\sigma_k} \frac{E_j^k}{Y^k} \quad (2.B.4)$$

$$(P_j^k)^{1-\sigma_k} = \sum_i \left( \frac{t_{ij}^k}{\Pi_i^k} \right)^{1-\sigma_k} \frac{Y_i^k}{Y^k} \quad (2.B.5)$$

$$p_i^k = \left( \frac{Y_i^k}{Y^k} \right)^{\frac{1}{1-\sigma}} \frac{1}{\alpha_i^k \Pi_j^k} \quad (2.B.6)$$

$$E_i^k = \eta^k \varphi_i Y_i \quad (2.B.7)$$

$$Y_i = \sum_k Y_i^k = \sum_k p_i^k Q_i^k \quad (2.B.8)$$

$$Y^k = \sum_i Y_i^k = \sum_i p_i^k Q_i^k \quad (2.B.9)$$

The sectoral system (2.B.3)-(2.B.9) is remarkably similar to the aggregate structural gravity system (2-1)-(2-5). In fact, from an expositional perspective, the only difference between the two gravity systems is the addition of the superscript and subscript “ $k$ ” in the sectoral system (2.B.3)-(2.B.9), the addition of the expenditure share  $\eta^k$  in the sectoral system in equation (2.B.7), and the addition of the adding up expression for the total value of output in a country in equation (2.B.8) as well as for the total value of output in a sector in the world in equation (2.B.9). One nice implication of this result is the so-called “separability” property of structural gravity, that is, the gravity system holds separately for each sector. From an estimation perspective, two important implications of the sectoral gravity system have to be highlighted:

- (i) The gravity equation can be estimated for each sector using exactly the same estimation techniques and best practice estimation approaches that apply to aggregate data discussed in Chapter 1.
- (ii) If the gravity model is estimated with data pooled across sectors, then the exporter and the importer fixed effects that are used to account for the multilateral resistances should also vary by sector. In other words, the gravity model should control for *exporter-sector* and *importer-sector* fixed effects.

The most important difference between the sectoral system (2.B.3)-(2.B.9) and the aggregate gravity system (2-1)-(2-5) is that the latter captures intersectoral linkages that arise on the demand side, i.e. due to the substitutability of goods across goods classes. The intuition is that in the sectoral setting consumers substitute not only varieties within each class of goods, but they also substitute goods from different classes with each other. The main implication of this result is that a change in trade costs between any given pair of countries in the world or in any given sector may potentially affect prices in all other sectors and in all other countries in the world. These links are captured by the system of market clearing conditions (2.B.6), which can be rewritten using the definitions of income, expenditure, and the multilateral resistances as follows:

$$\frac{p_i^k Q_i^k}{\sum_i p_i^k Q_i^k} = \sum_j \frac{(\alpha_i^k p_i^k t_{ij}^k)^{1-\sigma_k}}{\sum_i (\alpha_i^k p_i^k t_{ij}^k)^{1-\sigma_k}} \times \frac{\eta^k \varphi_j \sum_k p_j^k Q_j^k}{\sum_i p_i^k Q_i^k} \quad \forall i, k \quad (2.B.10)$$

The system (2.B.10) consists of  $N \times K$  equations in  $N \times K$  unknown  $p_j^k$ . However, similar to the aggregate gravity system, the sectoral gravity system can only be solved subject to normalisation for each sector because the system is homogeneous of degree zero in the vector of factory-gate prices. Anderson and Yotov (2016) propose and impose a natural normalisation by holding world real resources constant:

$$\sum_{i,k} p_i^k Q_i^k = \sum_{i,k} p_i^{k_0} Q_i^k = \sum_{i,k} Y_i^{k_0} \quad \forall i,k \quad (2.B.11)$$

Subject to this normalisation, the system (2.B.10) would deliver a unique vector of changes in factory-gate prices in response to a given change in sectoral bilateral trade costs. Importantly, it is clear from system (2.B.10) that a change in any possible sector-pair trade costs  $t_{ij}^k$  will result in factory-gate price changes in all countries and all sectors in the world.

### (a) Sectoral gravity from the supply side

Following the Appendix A of Chapter 1, which presents the derivation of the structural gravity framework at the aggregate level from the supply side, the aggregate structural gravity system is extended to the sectoral level by modifying some of the standard assumptions, as for example suggested by Eaton and Kortum (2002).

For each sector  $k$ , consumer preferences are still assumed to be homothetic, globally common/identical across countries, and approximated by a CES utility function:

$$U_j^k = \left[ \int_0^1 c^{k,l} \left( \frac{\sigma_k - 1}{\sigma_k} \right) dl \right]^{\frac{\sigma_k}{\sigma_k - 1}} \quad (2.B.12)$$

where  $j$  denotes the country and  $\sigma_k$  is the sector-specific elasticity of substitution among different varieties  $l \in [0,1]$  of sector  $k$ . As for the sectoral demand-side derivation, goods from different sectors are combined by a Cobb-Douglas utility function that reflects preference across different goods classes. As a result, for each country, the expenditure in each class of goods,  $E_j^k$ , is obtained as a constant share  $\eta^k$  of this country's total expenditure  $E_j$ :

$$E_j^k = \eta_k E_j = \eta_k \varphi_j Y_j \quad (2.B.13)$$

Now it holds in each sector that with constant returns to scale the cost of producing a unit of good  $l$  in sector  $k$  in country  $i$  is  $\varsigma_i^k / z_i^k(l)$ , with  $\varsigma_i^k$  denoting the input costs in sector  $k$  in country  $i$ . Taking iceberg trade costs into account, delivering a unit of good  $l$  of sector  $k$  produced in country  $i$  to country  $j$  costs:

$$p_{ij}^k(l) = \left( \frac{\varsigma_i^k}{z_i^k(l)} \right) t_{ij}^k \quad (2.B.14)$$

Keeping all other assumptions on the supply side for each sector  $k$ , similar steps to derive the lowest price across all sources, the distribution of prices, and exact price index leads to the following expression for the fraction of its expenditures on goods in sector  $k$  from country  $i$ ,  $X_{ij}^k$ :

$$X_{ij}^k = \frac{T_i^k (\varsigma_i^k t_{ij}^k)^{-\theta_k}}{\Phi_j^k} E_j^k = \frac{T_i^k (\varsigma_i^k t_{ij}^k)^{-\theta_k}}{\sum_{j=1}^N T_j^k (\varsigma_j^k t_{ij}^k)^{-\theta_k}} E_j^k \quad (2.B.15)$$

Using market clearance, the expressions for the multilateral resistance terms can be derived at the sectoral level. As in the aggregate case, the sectoral supply-side model is closed in a simple way for counterfactual analysis by assuming that there is a single factor of production, labour, where one unit of labour can produce one unit of output in each sector  $k$ , such that  $\varsigma_i^k = w_i^k$ . Accordingly, the market-clearing condition can be expressed as follows:

$$T_i^k (w_i^k)^{-\theta_k} = \frac{Y_i^k}{\sum_{j=1}^N \frac{(t_{ij}^k)^{-\theta_k}}{\Phi_j^k} E_j^k} = \frac{\frac{Y_i^k}{Y^k}}{\sum_{j=1}^N (\gamma^k)^{-\theta_k} \left( \frac{t_{ij}^k}{P_j^k} \right)^{-\theta_k} \frac{E_j^k}{Y^k}} = (\gamma^k)^{\theta_k} \frac{Y_i^k}{Y^k} (\Pi_i^k)^{\theta_k} \quad (2.B.16)$$

The sectoral gravity system derived from the supply side can then be written as:

$$X_{ij}^k = \frac{Y_i^k E_j^k}{Y^k} \left( \frac{t_{ij}^k}{\Pi_i^k P_j^k} \right)^{-\theta_k} \quad (2.B.17)$$

$$(\Pi_i^k)^{-\theta_k} = \sum_{j=1}^N \left( \frac{t_{ij}^k}{P_j^k} \right)^{-\theta_k} \frac{E_j^k}{Y^k} \quad (2.B.18)$$

$$(P_j^k)^{-\theta_k} = \sum_{i=1}^N \left( \frac{t_{ij}^k}{\Pi_i^k} \right)^{-\theta_k} \frac{Y_i^k}{Y^k} \quad (2.B.19)$$

$$w_i^k = \left( \frac{Y_i^k}{Y^k} \right)^{-\frac{1}{\theta_k}} \frac{(T_i^k)^{\theta_k}}{\gamma^k \Pi_i^k} \quad (2.B.20)$$

$$E_i^k = \eta_k \varphi_i Y_i \quad (2.B.21)$$

$$Y_i = \sum_k Y_i^k = \sum_k w_i^k L_i^k \quad (2.B.22)$$

$$Y^k = \sum_i Y_i^k = \sum_i w_i^k L_i^k \quad (2.B.23)$$

Hence, the aggregate structural gravity system described in Appendix A of Chapter 1 readily extends to the sectoral level. It also compares directly with the demand-side sectoral gravity system given by the system (2.B.3)-(2.B.9), with the only notable change of replacing  $1-\sigma_k$  by  $-\theta_k$ .

In the aggregate case, equation (2.B.20) was used to solve for wages. However, in a sector-setting, there is one such condition for each sector  $k$ . Unlike the aggregate model, there is not only one total labour supply  $L_i$ , but also sectoral labour allocations that have to be determined. Following Eaton and Kortum (2002), two cases can be considered to close the model: (1) labour is sectoral and internationally immobile; and (2) labour is mobile across sectors but not across countries.

### Immobile labour

The case of immobile labour is close to the assumption of sectoral given endowments made in the derivation of the demand-side sectoral model as sectoral labour allocations  $L_i^k$  are assumed to be exogenous. Equation (2.B.16) can be used together with the fact that the value of output in sector  $k$  of country  $i$  can be written as  $Y_i^k = w_i^k L_i^k$  to obtain an expression for  $w_i^k$ :

$$\frac{w_i^k L_i^k}{\sum_i w_i^k L_i^k} = \frac{T_i^k (w_i^k)^{-\theta_k}}{(\gamma^k)^{\theta_k} (\Pi_i^k)^{\theta_k}} \quad (2.B.24)$$

Replacing  $\Pi_i^k$  by its definition and  $F_j^k$  by the expression  $\left( (\gamma^k)^{-\theta_k} \sum_{i=1}^N T_i^k (w_i^k t_{ij}^k)^{-\theta_k} \right)^{\frac{1}{\theta_k}}$ , equation (2.B.24) can be rewritten as:

$$\begin{aligned} \frac{w_i^k L_i^k}{\sum_i w_i^k L_i^k} &= \frac{T_i^k (w_i^k)^{-\theta_k}}{(\gamma^k)^{\theta_k}} \left( \frac{\sum_{j=1}^N \frac{(t_{ij}^k)^{-\theta_k}}{\sum_{i=1}^N T_i^k (w_i^k t_{ij}^k)^{-\theta_k}} \times \frac{\eta^k \varphi_j \sum_k w_j^k L_j^k}{\sum_i w_i^k L_i^k}}{\sum_{j=1}^N \frac{T_j^k (w_j^k t_{ij}^k)^{-\theta_k}}{\sum_{i=1}^N T_i^k (w_i^k t_{ij}^k)^{-\theta_k}} \times \frac{\eta^k \varphi_j \sum_k w_j^k L_j^k}{\sum_i w_i^k L_i^k}} \right) \\ &= \left( \frac{\sum_{j=1}^N \frac{T_j^k (w_j^k t_{ij}^k)^{-\theta_k}}{\sum_{i=1}^N T_i^k (w_i^k t_{ij}^k)^{-\theta_k}} \times \frac{\eta^k \varphi_j \sum_k w_j^k L_j^k}{\sum_i w_i^k L_i^k}}{\sum_{j=1}^N \frac{T_j^k (w_j^k t_{ij}^k)^{-\theta_k}}{\sum_{i=1}^N T_i^k (w_i^k t_{ij}^k)^{-\theta_k}} \times \frac{\eta^k \varphi_j \sum_k w_j^k L_j^k}{\sum_i w_i^k L_i^k}} \right) \end{aligned} \quad (2.B.25)$$

These  $N \times K$  market-clearing conditions solve for the  $N \times K$  sectoral wages  $w_i^k$ . Note that this equation resembles equation (2.B.10) from the demand-side. Similarly, a numeraire for each sector has to be defined. With the same corresponding parameter values, the results under this scenario will be identical to the results from the endowment, demand-side model.

### Mobile labour

The case of perfectly mobile labour across sectors implies a common wage across sectors in country  $i$   $w_i$ , and endogenous sectoral labour allocations  $L_i^k$ . Taking the same steps as before, the same equation (2.B.25) is derived. As in the case of immobile labour only the total labour endowment in a country is given. In addition, the additional constraint  $L_i = \sum_k L_i^k$  implies that  $K-1$  sectoral labour allocations in each country have to be solved for by using equation (2.B.25). For the remaining sector, equation (2.B.25) can be used to solve for wages  $w_i$ . Note that this equation, which requires defining a numeraire for each sector, resembles equation (2.B.10) from the demand-side, even though the counterfactual results under the assumption of mobile labour will differ from those in the endowment setting.



## Appendix C: Structural gravity system in changes

The gravity system given by equations (2-1)-(2-5) can also be written and expressed in changes, referred to as the *exact hat algebra* (Dekle et al., 2007, 2008). In deriving the system in changes, the objective is to stick as close as possible to equations (2-1)-(2-5), and specifically also keep the multi-lateral resistance terms. Doing so, however, shows that information about baseline trade costs is used when formulating the system in changes. Dekle et al. (2007, 2008) use observed trade flows to formulate the system in changes in terms of trade shares. In this case, only changes of trade costs, but not baseline levels of trade costs for solving the counterfactual values are necessary.

Let baseline and counterfactual values be denoted with a superscript *BLN* and *CFL*, respectively. The change for any variable *Z* is defined as  $\tilde{Z} = Z^{CFL}/Z^{BLN}$ . Given the multiplicative nature of the trade flow equation (2-1), the change in bilateral trade flow can be computed by dividing the counterfactual values by the baseline values:

$$\tilde{X}_{ij} = \frac{\tilde{Y}\tilde{E}_j}{\tilde{Y}} \left( \frac{\tilde{t}_{ij}}{\tilde{\Pi}_i\tilde{P}_j} \right)^{1-\sigma}$$

Note that typically  $\tilde{t}_{ij}$  defines the counterfactual scenario of interest. For example, if the objective is to evaluate the trade and welfare effects of a given RTA, the *RTA* dummy would be set to zero for the countries that are party to the RTA, defining  $t_{ij}^{CFL}$ . Hence,  $\tilde{t}_{ij}$  is exogenously given.

Using equation (2-2) and the fact that  $\tilde{X}X^{BLN} = X^{CFL}$ , the change in outward multilateral resistances is given by:

$$\left(\Pi_i^{BLN}\right)^{1-\sigma} \tilde{\Pi}_i^{1-\sigma} = \sum_{j=1}^N \left( \frac{t_{ij}^{BLN}\tilde{t}_{ij}}{P_j^{BLN}\tilde{P}_j} \right)^{1-\sigma} \frac{E_j^{BLN}\tilde{E}_j}{Y^{BLN}\tilde{Y}}$$

Similarly, using equation (2-3), the change in inward multilateral resistances is expressed as:

$$\left(P_j^{BLN}\right)^{1-\sigma} \tilde{P}_j^{1-\sigma} = \sum_{i=1}^N \left( \frac{t_{ij}^{BLN}\tilde{t}_{ij}}{\Pi_i^{BLN}\tilde{\Pi}_i} \right)^{1-\sigma} \frac{Y_i^{BLN}\tilde{Y}_i}{Y^{BLN}\tilde{Y}}$$

Using equation (2-4) the changes of factory-gate prices is given by:

$$\tilde{p}_i = \frac{(\tilde{Y}_i/\tilde{Y})^{\frac{1}{1-\sigma}}}{\tilde{\Pi}_i}$$

where

$$\tilde{Y} = \frac{\sum_{i=1}^N Y_i^{CFL}}{\sum_{i=1}^N Y_i^{BLN}} \quad \longrightarrow \quad Y^{BLN}\tilde{Y} = \sum_{i=1}^N Y_i^{BLN}\tilde{Y}_i$$

Since endowments are assumed to remain constant, equation (2-5) can be used to express the change in total nominal output for country  $i$  as:

$$\tilde{Y}_i = \tilde{p}_i = \frac{(\tilde{Y}_i/\bar{Y})^{\frac{1}{1-\sigma}}}{\tilde{\Pi}_i}$$

In addition, total nominal output changes and total spending changes are linked as follows:

$$\tilde{E}_i = \tilde{\varphi}_i \tilde{Y}_i$$

where  $\tilde{\varphi}_i$  are the exogenous changes in the trade imbalances of country  $i$ .

Hence, the structural gravity system in changes is given by the following set of equations:

$$\tilde{X}_{ij} = \frac{\tilde{Y}_i \tilde{E}_j}{\tilde{Y}} \left( \frac{\tilde{t}_{ij}}{\tilde{\Pi}_i \tilde{P}_j} \right)^{1-\sigma} \quad (2.C. 1)$$

$$(\Pi_i^{BLN})^{1-\sigma} \tilde{\Pi}_i^{1-\sigma} = \sum_{j=1}^N \left( \frac{t_{ij}^{BLN} \tilde{t}_{ij}}{P_j^{BLN} \tilde{P}_j} \right)^{1-\sigma} \frac{E_j^{BLN} \tilde{E}_j}{Y^{BLN} \tilde{Y}} \quad (2.C. 2)$$

$$(P_j^{BLN})^{1-\sigma} \tilde{P}_j^{1-\sigma} = \sum_{i=1}^N \left( \frac{t_{ij}^{BLN} \tilde{t}_{ij}}{\Pi_i^{BLN} \tilde{\Pi}_i} \right)^{1-\sigma} \frac{Y_i^{BLN} \tilde{Y}_i}{Y^{BLN} \tilde{Y}} \quad (2.C. 3)$$

$$\tilde{p}_i = \frac{(\tilde{Y}_i/\bar{Y})^{\frac{1}{1-\sigma}}}{\tilde{\Pi}_i} \quad (2.C. 4)$$

$$Y^{BLN} \tilde{Y} = \sum_{i=1}^N Y_i^{BLN} \tilde{Y}_i \quad (2.C. 5)$$

$$\tilde{Y}_i = \tilde{p}_i \quad (2.C. 6)$$

$$\tilde{E}_i = \tilde{\varphi}_i \tilde{Y}_i \quad (2.C. 7)$$

This system requires only data on total nominal output ( $Y_i^{BLN}$ ), total spending ( $E_i^{BLN}$ ), and trade costs ( $t_{ij}^{BLN}$ ) in the baseline, and a value for the elasticity of substitution  $\sigma$ . Specifically, information about the constant elasticity of substitution preference parameter  $\alpha_j$  is not needed. With given nominal output, expenditures, and trade costs, the baseline  $\Pi_i^{BLN}$  and  $P_j^{BLN}$  can also be recovered. Hence, the structural gravity system in changes is readily solvable, since the system involves seven equations with seven unknown changes  $\tilde{X}_{ij}$ ,  $\tilde{\Pi}_i$ ,  $\tilde{P}_j$ ,  $\tilde{p}_i$ ,  $\tilde{Y}$ ,  $\tilde{Y}_i$ , and  $\tilde{E}_i$ .

## Endnotes

- 1 This chapter is based on the paper “General Equilibrium Trade Policy Analysis with Structural Gravity” prepared by Larch and Yotov (2016a).
- 2 If the actual set of bilateral trade costs is replaced by  $\tilde{\tau}_{ij} = \Pi_i P_j$ , all budget constraints and market clearing conditions continue to hold, and factory-gate prices and supply and expenditure shares remain constant. Thus, the multilateral resistances can be thought of as the general equilibrium similar to a tax incidence decomposition. The interested reader may refer to Anderson and van Wincoop (2004) for a related discussion.
- 3 No explicit normalisation is needed in the less realistic case with symmetric trade costs and balanced trade. In this case the multilateral resistances system collapses to a system of  $N$  equations under the implicit normalisation  $P_j \equiv \Pi_j$ .
- 4 Alvarez and Lucas, Jr. (2007) and Allen et al. (2014) have established the uniqueness of the equilibria in the structural gravity system presented here.
- 5 Note that these channels are defined slightly differently than in Head and Mayer (2014): the “direct/partial equilibrium” channel corresponds to the “partial trade impact” (PTI); the “conditional general equilibrium” corresponds to the “modular trade impact” (MTI); and the “full endowment general equilibrium” corresponds to the “general equilibrium trade impact” (GETI). The names of the channels are different in this *Advanced Guide* to highlight the fact that the analysis does not only apply to trade, but also to output, expenditure, prices, and welfare.
- 6 In order to see this point, the system of equations (2-2)-(2-5) can be expressed only in terms of factory-gate prices as the only endogenous variable by applying the definitions of the multilateral resistances. Thus, the multilateral resistance system collapses to a system of  $N$  equations in  $N$  unknowns, which can translate any change in bilateral trade costs directly into a change in factory-gate prices (Balistreri and Hillberry, 2007; Balistreri and Hillberry, 2008). Moreover, in combination with the (exogenous) change in bilateral trade costs, the change in factory-gate price is sufficient to construct a unique corresponding set of changes in inward and outward multilateral resistances.
- 7 Equation (2-12) departs from the standard linear law of motion for capital accumulation. However, a great advantage of this functional form is that it delivers a closed-form solution for the transition path of capital accumulation, which is extremely convenient for analysis and decomposition of the general equilibrium effects of trade policy. Anderson et al. (2015c; 2016a) discuss the empirical implications of the assumption of log-linear capital accumulation specification. More importantly, Anderson et al. (2015c; 2016a) demonstrate that the only difference between the dynamic gravity system presented here and the one with linear capital accumulation is that the closed-form solution for capital accumulation presented below will be replaced by a standard Euler equation, with no implications for the baseline structural gravity system.
- 8 Two *CTB*-related indexes have been proposed in the literature (Anderson et al., 2014). The *constructed foreign bias (CFB)* index is defined as the predicted volume of international export trade relative to the hypothetical frictionless volume of trade. The *constructed domestic bias (CDB)* index corresponds to the ratio of fitted to frictionless intra-national trade, excluding trade within sub-regions in a country. The *CFB* index may be particularly useful to assess the effects of trade policy on international trade, while the *CDB* index can be used to evaluate the intra-national effects of trade policy.
- 9 The different models considered by Arkolakis et al. (2012) share four main assumptions including (i) Dixit-Stiglitz preferences; (ii) one factor of production; (iii) linear cost functions; and (iv) perfect or monopolistic competition. In addition, the following macro-level conditions must be satisfied: (i) balanced trade; (ii) aggregate profits representing a constant share of aggregate revenues; and (iii) the import demand system is CES.
- 10 Among a universe of general equilibrium models that calibrate and simulate trade, the following are notable examples that all feature actual gravity estimations that accompany their counterfactual analysis: Anderson and Yotov (2010b); Egger and Larch (2011); Egger et al. (2011); Ossa (2011); Fieler (2011); Costinot et al. (2012); Behrens et al. (2014); Eaton et al. (2013); Arkolakis et al. (2013); Allen et al. (2014); Felbermayr et al. (2015); Heid (2015); Caliendo and Parro (2015); and Heid and Larch (2016).
- 11 Although it is possible that despite best efforts to capture all possible drivers of trade frictions, the error term in the gravity estimations may still contain some systematic information about trade costs, the assumption of stochastic errors does not seem too strong in structural gravity estimations in the presence of a rich structure of fixed effects (i.e. directional time-varying fixed effects and pair fixed effects).

- 12 The interested reader may refer to Anderson and Yotov (2010b); Aichele et al. (2014); Larch and Wanner (2014); and Anderson and Yotov (2016), who construct confidence intervals for specific general equilibrium effects of trade policy. In principle, the approach from Anderson et al. (2015b) may be used to deliver standard errors for general equilibrium effects directly from the estimates of the gravity fixed effects. In addition, only recently the consistency of the model parameter estimates in nonlinear panel models with two types of fixed effects has been shown by Fernández-Valz and Weidner (2016). Hence, exploring the possibility to construct standard errors from the gravity directional fixed effects is an interesting future research area.
- 13 Although specification (2-43) looks very similar to the *exact hat algebra* procedures from Dekle et al. (2008), the changes in the factory-gate prices implied by equation (2-43) do not capture the full endowment general equilibrium changes, because they only reflect the conditional outward multilateral resistances without allowing immediate changes in the value of output. That is why these initial changes in the factory-gate prices are labelled *first-order*.
- 14 According to the results based on a perfect competition framework with intermediates reported in Table 4.1 in Costinot and Rodriguez-Clare (2014), the welfare gains for the United States are obtained to be 8.3 percent, which is very close to the value of the potential gains from the removal of borders calculated at 10.6 percent. Similarly, the welfare increase for Germany calculated to be 21.3 percent is relatively similar to the 24.3 percent in welfare gains associated with the removal of international borders.
- 15 Recent studies that evaluate the effects of NAFTA include Shikher (2012), Rolfeigh (2013), Zylkin (2014), Anderson et al. (2015c, 2016a) and Caliendo and Parro (2015). Earlier examples include Kehoe (2003), Lederman et al. (2005), Trefler (2004), and Romalis (2007). Finally, NAFTA has been the object of interest of a series of papers in the computational general equilibrium literature from the nineties (Brown et al., 1992a, 1992b; McCleery, 1992; Klein and Salvatore, 1995; Fox, 1999; Krueger, 1999).
- 16 This experiment follows the top-down approach of Felbermayr et al. (2015) and Anderson and Yotov (2016) and makes the implicit assumption that the effect of NAFTA is equal to the average effect of the RTAs from the period of investigation. This approach has the advantage of being easy to implement and of capturing additional non-tariff barriers to trade without requiring additional data. However, it could potentially under- or over-estimate the effects of NAFTA. If NAFTA goes deeper than the average agreement, the effect will be underestimated, while it will lead to an overestimation of the effects of NAFTA if the easy barriers to trade have already been eliminated (such as huge tariffs). An alternative approach, which is the object of an exercise in the next section, is to obtain a specific estimate of the RTA under investigation by introducing an additional indicator covariate for NAFTA in the gravity specification and then using the estimate of NAFTA dummy to obtain the general equilibrium effects (Zylkin, 2014; Baier et al., 2016).
- 17 Note that in order to perform the conditional and the full endowment general equilibrium analysis, only data for one base year is needed. In principle, it is possible to estimate phasing-in effects of NAFTA, which will vary over time, and then use the full panel dimension of the sample in order to obtain the general equilibrium effects that correspond to the partial equilibrium phasing-in indexes in each year.
- 18 It should be noted that the analysis presented here does not take into account the effects of the original RTA between Canada and the United States from the late eighties.



## REFERENCES

---

- Agnosteva, D., Anderson, J. E. and Yotov, Y. V. (2014), 'Intra-National Trade Costs: Measures and Aggregation', Cambridge, MA, National Bureau of Economic Research, NBER Working Paper No. 19872.
- Aichele, R., Felbermayr, G. J. and Heiland, I. (2014), 'Going Deep: the Trade and Welfare Effects of TTIP', Munich, CESifo, Working Paper No. 5150.
- Allen, T., Arkolakis, C. and Takahashi, Y. (2014), 'Universal Gravity', Cambridge, MA, National Bureau of Economic Research, NBER Working Paper No. 20787.
- Alvarez, F. and Lucas Jr, R. E. (2007) *General Equilibrium Analysis of the Eaton - Kortum Model of International Trade*. Journal of Monetary Economics 54[6], 1726-1768.
- Anderson, J. E. (1979) *A Theoretical Foundation for the Gravity Equation*. American Economic Review 69[1], 106-116.
- Anderson, J. E. (2011) *The Gravity Model*. Annual Review of Economics 3, 133-160.
- Anderson, J.E., Borchert, I., Mattoo, A., and Yotov, Y. V. (2015a) 'Modeling Services Trade, Trade Costs, Borders and Output', Manuscript.
- Anderson, J.E., Larch, M., Novy, D. and Yotov, Y. V. (2016b). "Internal Trade Costs." Manuscript
- Anderson, J. E., Larch, M. and Yotov, Y. V. (2015b), 'Estimating General Equilibrium Trade Policy Effects: GE PPML', Munich, CESifo, Working Paper No. 5592.
- Anderson, J. E., Larch, M. and Yotov, Y. V. (2015c), 'Growth and Trade With Frictions: a Structural Estimation Framework', Cambridge, MA, National Bureau of Economic Research, NBER Working Paper No. 21377.
- Anderson, J. E., Larch, M. and Yotov, Y. V. (2015d) 'On the Growth Effects of the Transatlantic Trade and Investment Partnership', Manuscript.
- Anderson, J. E., Larch, M. and Yotov, Y. V. (2016a), 'Growth and Trade With Frictions: a Structural Estimation Framework', manuscript.
- Anderson, J. E., Milot, C. A., and Yotov, Y. V. (2014) *How Much Does Geography Deflect Services Trade*. International Economic Review 55[3], 791-818.
- Anderson, J. E. and Neary, P. J. (2005), *Measuring the Restrictiveness of International Trade Policy*, Cambridge, MA: The MIT Press.
- Anderson, J. E. and van Wincoop, E. (2001), 'Borders, Trade and Welfare', Cambridge, MA, National Bureau of Economic Reserch, NBER Working Paper 8515.
- Anderson, J. E. and van Wincoop, E. (2003) *Gravity With Gravitas: a Solution to the Border Puzzle*. American Economic Review 93[1], 170-192.
- Anderson, J. E. and van Wincoop, E. (2004) *Trade Costs*. Journal of Economic Literature 42[3], 691-751.
- Anderson, J. E., Vesselovsky, M., and Yotov, Y. V. (2016c) *Gravity With Scale Economies*. Journal of International Economics 100, 174-193.
- Anderson, J. E. and Yotov, Y. V. (2010a), 'Specialization: Pro- and Anti-Globalizing, 1990-2002', Cambridge, MA, National Bureau of Economic Research, NBER Working Paper No. 16301.
- Anderson, J. E. and Yotov, Y. V. (2010b) *The Changing Incidence of Geography*. American Economic Review 100[5], 2157-2186.

- Anderson, J. E. and Yotov, Y. V. (2011), 'Terms of Trade and Global Efficiency Effects of Free Trade Agreements, 1990-2002', Cambridge, MA, National Bureau of Economic Research, NBER Working Paper No. 17003.
- Anderson, J.E., and Yotov, A. V. (2012) 'Gold Standard Gravity', NBER Working Paper No. 17835.
- Anderson, J. E. and Yotov, Y. V. (2016) *Terms of Trade and Global Efficiency Effects of Free Trade Agreements, 1990-2002*. Journal of International Economics 99[C], 279-298.
- Arkolakis, C., Costinot, A., Donaldson, D. and Rodriguez-Claire, A. (2015), 'The Elusive Pro-Competitive Effects of Trade', Cambridge, MA, National Bureau of Economic Research, NBER Working Paper No. 21370.
- Arkolakis, C., Costinot, A., and Rodriguez-Claire, A. (2012) *New Trade Models, Same Old Gains?* American Economic Review 102[1], 94-130.
- Arkolakis, C., Ramondo, N., Rodriguez-Claire, A. and Yeaple, S. (2013), 'Innovation and Production in the Global Economy', Cambridge, MA, National Bureau of Economic Research, NBER Working Paper No. 18972.
- Armington, P. S. (1969), 'A Theory of Demand for Products Distinguished by Place of Production', *IMF Staff Papers* 16(1): 159-176.
- Arvis, J.-F. and Shepherd, B. (2013) *The Poisson Quasi-Maximum Likelihood Estimator: a Solution to the Adding Up Model in Gravity Models*. Applied Economics Letters 20[6], 515-519.
- Baier, S. L. and Bergstrand, J. H. (2002), 'On the Endogeneity of International Trade Flows and Free Trade Agreements', unpublished, retrieved from [http://www3.nd.edu/~jbergstr/Working\\_Papers/EndogeneityAug2002.pdf](http://www3.nd.edu/~jbergstr/Working_Papers/EndogeneityAug2002.pdf).
- Baier, S. L. and Bergstrand, J. H. (2004) *The Economic Determinants of Free Trade Agreements*. Journal of International Economics 64[1], 29-63.
- Baier, S. L. and Bergstrand, J. H. (2007) *Do Free Trade Agreements Actually Increase Members' International Trade?* Journal of International Economics 71[1], 72-95.
- Baier, S. L. and Bergstrand, J. H. (2009) *Estimating the Effects of Free Trade Agreements on International Trade Flows Using Matching Econometrics*. Journal of International Economics 77[1], 63-76.
- Baier, S. L., Yotov, Y. V. and Zylkin, T. (2016), 'On the Widely Differing Effects of Free Trade Agreements: Lessons From Twenty Years of Trade Integration', manuscript.
- Baldwin, R., Forslid, R., Martin, P., Ottaviano, G. and Robert-Nicoud, F. (2011), *Economic Geography and Public Policy*, Princeton University Press.
- Baldwin, R. and Taglioni, D. (2006), 'Gravity for Dummies and Dummies for Gravity Equations', Cambridge, MA, National Bureau of Economic Research, NBER Working Paper No. 12516.
- Balistreri, E. J. and Hillberry, R. H. (2007) *Structural Estimation and the Border Puzzle*. Economic Inquiry 72[2], 451-463.
- Balistreri, E. J. and Hillberry, R. H. (2008) *The Gravity Model: an Illustration of Structural Estimation As Calibration*. Economic Inquiry 46[4], 511-1348.
- Behrens, K., Mion, G., Murata, Y., and Südekum, J. (2014) *Trade, Wages, and Productivity*. International Economic Review 55[4], 1305-1348.
- Bergstrand, J. H. (1985) *The Gravity Equation in International Trade: Some Microeconomic Foundations and Empirical Evidence*. Review of Economics and Statistics 67[3], 474-481.
- Bergstrand, J. H., Egger, P., and Larch, M. (2016) *Economic Determinants of the Timing of Preferential Trade Agreements Formations and Enlargements*. Economic Inquiry 54[1], 315-341.
- Bergstrand, J. H., Larch, M., and Yotov, Y. V. (2015) *Economic Integration Agreements, Border Effects, and Distance Elasticities in Gravity Equations*. European Economic Review 78, 307-327.
- Bertrand, M., Duflo, E. and Mullainathan, S. (2004), 'How Much Should We Trust Differences-In-Differences Estimates?', *The Quarterly Journal of Economics* 119(1): 249-275.

- Borchert, I., Batshur, G. and Mattoo, A. (2012), 'Guide to Services Trade Restrictions Database', Washington DC, World Bank, Policy Research Working Paper WPS6108.
- Borchert, I. and Yotov, Y. V. (2016), 'Globalization and International Trade', manuscript.
- Bouët, A., Decreux, Y., Fontagné, L., Jean, S. and Laborde, D. (2005), 'A Consistent, Ad-Valorem Equivalent Measure of Applied Protection Across the World: the MacMap - HS6 Database', Paris, Centre d'Études Prospectives et d'Information Internationales, CEPII Working Paper No. 2004-22.
- Boulhol, H. and de Serres, A. (2010) *Have Developed Countries Escaped the Curse of Distance?* Journal of Economic Geography 10[1], 113-139.
- Broda, C., Greenfield, J. and Weinstein, D. (2006), 'From Groundnuts to Globalization: a Structural Estimate of Trade and Growth', Cambridge, MA, National Bureau of Economic Research, NBER Working Paper No. 12512.
- Brown, D. K., Deardoff, A., and Stern, R. M. (1992a) *A North American Free Trade Agreement: Analytical Issues and a Computational Assessment*. The World Economy 15[1], 1-30.
- Brown, D. K., Deardoff, A., and Stern, R. M. (1992b) *North American Integration*. Economic Journal 102[415], 1507-1518.
- Brun, J.-F., Carrère, C., Guillaumont, P., and de Melo, J. (2005) *Has Distance Died? Evidence From a Panel Gravity Model*. World Bank Economic Review 19[1], 99-120.
- Buch, C., Kleinert, J., and Toubal, F. (2004) *The Distance Puzzle: on the Interpretation of the Distance Coefficient in Gravity Equations*. Economics Letters 83[3], 293-298.
- Caliendo, L. and Parro, F. (2015), 'Estimates of the Trade and Welfare Effects of NAFTA', *The Review of Economic Studies* 82(1): 1-44.
- Carrère, C. and Schiff, M. (2005) *On the Geography of Trade. Distance Is Alive and Well*. Revue économique 56[6], 1249-1274.
- Chaney, T. (2008) *Distorted Gravity: the Intensive and Extensive Margins of International Trade*. American Economic Review 98[4], 1707-1721.
- Cheng, I.-H. and Wall, H. J. (2005) *Controlling for Heterogeneity in Gravity Models of Trade and Integration*. Federal Reserve Bank of St.Louis Review 87[1], 49-63.
- Chor, D. (2010) *Unpacking Sources of Comparative Advantage: A Quantitative Approach*. Journal of International Economics 82, 152-167.
- Coe, D. T., Subramanian, A., Tamirisia, N. T. and Bhavnani, R. (2002), 'The Missing Globalization Puzzle', Washington DC, International Monetary Fund, IMF Working Paper No. 171.
- Costinot, A., Donaldson, D., and Komunjer, I. (2012) *What Goods Do Countries Trade? A Quantitative Exploration of Ricardo's Ideas*. Review of Economic Studies 79[2], 581-608.
- Costinot, A. and Rodriguez-Claire, A. (2014), 'Trade Theory With Numbers: Quantifying the Consequences of Globalization', in Gopinath, G., Helpman, E., and Rogoff, K. (eds) , *Handbook of International Economics, Vol. 4*, Oxford: Elsevier Ltd.
- Dai, M., Yotov, Y. V., and Zylkin, T. (2014) *On the Trade-Diversion Effects of Free Trade Agreements*. Economic Letters 122[2], 321-325.
- Dawkins, C., Srinivasan, T. N. and Whalley, J. (2001), 'Calibration', in Heckman, J. J. and Leamer, E.E. (eds) , *Handbook of Econometrics, Volume 5*, Amsterdam: Elsevier.
- Deardoff, A. (1998), 'Determinants of Bilateral Trade: Does Gravity Work in a Neoclassical World?', in Frankel, J. A. (ed) , *The Regionalization of the World Economy*, Chicago: University of Chicago Press.
- Dekle, R., Eaton, J., and Kortum, S. (2007) *Unbalanced Trade*. American Economic Review: Papers and Proceedings 97[2], 351-355.
- Dekle, R., Eaton, J., and Kortum, S. (2008) *Global Rebalancing With Gravity: Measuring the Burden of Adjustment*. IMF Staff Papers 55[3], 511-540.
- Disdier, A.-C. and Head, K. (2008) *The Puzzling Persistence of the Distance Effect on Bilateral Trade*. Review of Economics and Statistics 90[1], 37-48.



- Donaldson, D. (2016) *Railroads of the Raj: Estimating the Impact of Transportation Infrastructure*. American Economic Review forthcoming.
- Eaton, J. and Kortum, S. (2002) *Technology, Geography and Trade*. *Econometrica* 70[5], 1741-1779.
- Eaton, J., Kortum, S. and Sotelo, S. (2013), 'International Trade: Linking Micro and Macro', in Acemoglu, D., Arellano, M., and Dekel, E. (eds) , *Advances in Economics and Econometrics - Tenth World Congress. Volume II. Applied Econometrics*, Cambridge: Cambridge University Press.
- Eaton, J., Kortum, S., Neiman, B. and Romalis, J. (2016) *Trade and the Global Recession* American Economic Review, forthcoming.
- Eaton, J. and Tamura, A. (1995), 'Bilateralism and Regionalism in Japanese and U.S. Trade and Direct Foreign Investment Patterns', Cambridge, MA, National Bureau of Economic Research, NBER Working Paper No. 4758.
- Egger, P. and Larch, M. (2008), 'Interdependent Preferential Trade Agreement Membership: an Empirical Analysis', *Journal of International Economics* 76: 384-399.
- Egger, P. and Larch, M. (2011) *An Assessment of the Europe Agreements' Effects on Bilateral Trade, GDP, and Welfare*. *European Economic Review* 55[2], 263-279.
- Egger, P. and Larch, M. (2012) *Tariff Evasion Effects in Quantitative General Equilibrium*. *Economics Letters* 116[2], 262-264.
- Egger, P., Larch, M., Staub, K., and Winkelmann, R. (2011) *The Trade Effects of Endogenous Preferential Trade Agreements*. *American Economic Journal: Economic Policy* 3[3], 113-143.
- Egger, P. and Nigai, S. (2015) *Structural Gravity With Dummies Only: Constrained ANOVA-Type Estimation of Gravity Models*. *Journal of International Economics* 97[1], 86-99.
- Egger, P. and Staub, K. (2016) *GLM Estimation of Trade Gravity Models With Fixed Effects*. *Empirical Economics* 50, 137-175.
- Fally, T. (2015) *Structural Gravity and Fixed Effects*. *Journal of International Economics* 97[1], 76-85.
- Feenstra, R. C. (2016), *Advanced International Trade: Theory and Evidence*, 2nd Princeton: Princeton University Press.
- Feenstra, R. C. and Romalis, J. (2014) *International Prices and Endogenous Quality*. *The Quarterly Journal of Economics* 129[2], 477-527.
- Felbermayr, G. J., Heid, B., Larch, M., and Yalcin, E. (2015) *Macroeconomic Potentials of Transatlantic Free Trade: a High Resolution Perspective for Europe and the World*. *Economic Policy* 83[3], 491-537.
- Fernández-Val, I. and Weidner, M. (2016) *Individual and Time Effects in Nonlinear Panel Models With Large N, T*. *Journal of Econometrics* 192[1], 291-312.
- Fieler, A. C. (2011) *Nonhomotheticity and Bilateral Trade: Evidence and a Quantitative Explanation*. *Econometrica* 79[4], 1069-1101.
- Fox, A. K. (1999), 'Evaluating the Success of a CGE Model of the Canada - US Free Trade Agreement', presented at The Second Annual Conference in Global Economic Analysis, June 20 - 22, 1999.
- Francois, J. and Pindyuk, O. (2013), 'Consolidated Data on International Trade in Services', Rotterdam, Institute for International and Development Economics, IIDE Discussion Paper 20130101.
- Frankel, J. A. and Romer, D. (1999) *Does Trade Cause Growth?* *American Economic Review* 89[3], 379-399.
- Genereux, PA. and Langen, B. (2002), 'The Derivation of Provincial (Inter-Regional) Trade Flows: the Canadian Experience', Montréal, Statistics Canada Working Paper No. 98.
- Handley, K. (2014) *Exporting Under Trade Policy Uncertainty: Theory and Evidence*. *Journal of International Economics* 94[1], 50-66.

- Handley, K. and Limão, N. (2013), 'Policy Uncertainty, Trade and Welfare: Theory and Evidence for China and the U.S.', Cambridge, MA, National Bureau for Economic Research, NBER Working Paper No. 19376.
- Head, K. and Mayer, T. (2013) *What Separates Us? Sources of Resistance to Globalization*. Canadian Journal of Economics 46[4], 1196-1231.
- Head, K. (2003), 'Gravity for beginners', mimeo, University of British Columbia.
- Head, K. and Mayer, T. (2014), 'Gravity Equations: Workhorse, Toolkit, and Cookbook.', in Gopinath, G., Helpman, E., and Rogoff, K. (eds) , *Handbook of International Economics, Vol. 4*, Oxford: Elsevier B. V.
- Head, K., Mayer, T. and Ries, J. (2010), 'The Erosion of Colonial Trade Linkages After Independence', *Journal of International Economics* 81(1): 1-14.
- Head, K. and Ries, J. (2001), 'Increasing Returns Versus National Product Differentiation As an Explanation for the Pattern of U.S.-Canada Trade', *The American Economic Review* 91(4): 858-876.
- Heid, B. (2015), 'Regional Trade Agreements, Unemployment, and the Informal Sector', CESifo Area Conference on Global Economy.
- Heid, B. and Larch, M. (2016) *Gravity With Unemployment*. Journal of International Economics 101[July], 70-85.
- Heid, B., Larch, M. and Yotov, Y. V. (2015), 'A Simple Method to Estimate the Effects of Non-Discriminatory Trade Policy Within Structural Gravity Models', unpublished, retrived from <http://www.etsg.org/ETSG2015/Papers/439.pdf>.
- Helpman, E., Melitz, M., and Rubinstein, Y. (2008) *Trading Partners and Trading Volumes*. Quarterly Journal of Economics 123[2], 441-487.
- Horn, H., Mavroidis, P. C. and Sapir, A. (2010), 'Beyond the WTO? an Anatomy of EU and US Preferential Trade Agreements', *The World Economy* 33(11): 1565-1588.
- Hummels, D. (2001), 'Toward a Geography of Trade Costs', unpublished, retrieved from <http://www.krannert.purdue.edu/faculty/hummelsd/research/toward/tgtc.pdf> .
- Kehoe, T. (2003), 'An Evaluation of the Performance of Applied General Equilibrium Models of the Impact of NAFTA', Minneapolis, Federal Reserve Bank of Minneapolis, Research Department Staff Report No. 320.
- Klein, L. and Salvatore, D. (1995) *Welfare Effects of the North American Free Trade Agreement*. Journal of Policy Modeling 17[2], 163-176.
- Kristjánisdóttir, H. (2012), 'Exports From a Remote Developed Region: Analysed by an Inverse Hyperbolic Sine Transformation of the Gravity Model', *The World Economy* 35(7): 953-966.
- Krueger, A. O. (1999), 'Trade Creation and Trade Diversion Under NAFTA', Cambridge, Massachusetts, National Bureau of Economic Research, NBER Working Paper No. 7429.
- Krugman, P. R. (1995), 'Increasing Returns, Imperfect Competition and the Positive Theory of International Trade', in Grossman, G. and Rogoff, K. (eds) , *Handbook of International Economics. Vol. 3*, Amsterdam: Elsevier.
- Krugman, P. R. (2011), 'Calibration and All That (Wonkish)', New York Times Column from October 18th, 2011.
- Larch, M., Norbäck, P.-J., Sirries, S., and Urban, D. (2016) *Heterogeneous Firms, Globalization and the Distance Puzzle*. The World Economy . forthcoming
- Larch, M. and Wanner, J. (2014), 'Carbon Tariffs: an Analysis of Trade, Welfare and Emission Effects', Munich, Centre for Economic Studies, CESifo Working Paper No. 4598.
- Larch, M. and Yotov, Y. V. (2016a), 'General Equilibrium Trade Policy Analysis With Structural Gravity', Geneva, World Trade Organization, WTO Working Paper ERSD 2016-08.
- Larch, M. and Yotov, Y. V. (2016b), 'Trade Policy Analysis With Structural Gravity: *General Equilibrium Implications*', unpublished.
- Lederman, D., Maloney, W. F., and Servén, L. (2005) *Lessons From NAFTA for Latin America and the Caribbean*, Washington D.C.: World Bank.

- Lin, F. and Sim, N. C. S. (2012) *Death of Distance and the Distance Puzzle*. *Economics Letters* 116[2], 225-228.
- Lucas, R. E. and Prescott, E. C. (1971) *Investment Under Uncertainty*. *Econometrica* 39[5], 659-681.
- Magee, C. S. (2003) *Endogenous Preferential Trade Agreements: an Empirical Analysis*. *Contributions to Economic Analysis & Policy* 2[1].
- Martin, W. J. and Pham, C. S. (2008), 'Estimating the Gravity Equation When Zero Trade Flows Are Frequent', Melbourne, Deakin University, School of Accounting, Economics and Finance, Working Paper No. 2008-03.
- Mayer, T. and Zignago, S. (2011), 'Notes on CEPII's Distances Measures: the *GeoDist* Database', Paris, Centre d'Études Prospectives et d'Information Internationales, CEPII Working Paper No. 2011-25.
- McCallum, J. (1995) *National Borders Matter*. *American Economic Review* 85[3], 615-623.
- McCleery, R. K. (1992), 'An Intertemporal Linked Macroeconomic CGE Model of the United States and Mexico Focussing on Demographic Change and Factor Flows', in Francois, J. and Shiells, C.R. (eds), *Economy - Wide Modelling of the Economic Implications of a FTA with Mexico and a NAFTA with Canada and Mexico. Report on Investigation No. 332 - 317 under Section 332 of the Tariff Act of 1930*, USITC.
- Melitz, J. (2008) *Language and Foreign Trade*. *European Economic Review* 52[4], 667-699.
- Melitz, J. and Toubal, F. (2014) *Native Language, Spoken Language, Translation and Trade*. *Journal of International Economics* 93[2], 351-363.
- Melitz, M. J. (2003) *The Impact of Trade on Intra-Industry Reallocations and Aggregate Industry Productivity*. *Econometrica* 71[6], 271-282.
- Novy, D. (2013), 'Gravity Redux: Measuring International Trade Costs With Panel Data', *Economic Inquiry* 51(1): 101-121.
- Olivero, M. P. and Yotov, Y. V. (2012) *Dynamic Gravity: Endogenous Country Size and Asset Accumulation*. *Canadian Journal of Economics* 45[1], 64-92.
- Osnago, A., Piermartini, R. and Rocha, N. (2015), 'Trade Policy Uncertainty As Barrier to Trade', Geneva, World Trade Organization, WTO Working Paper ERSD-2015-05.
- Ossa, R. (2011) *A New Trade Theory of GATT/WTO Negotiations*. *Journal of Political Economy* 119[1], 122-152.
- Ottaviano, G. I. P. (2016), 'European Integration and the Gains From Trade', in Badinger, H. and Nitsch, V. (eds), *The Routledge Handbook of the Economics of European Integration*, London: Routledge.
- Piermartini, R. and Yotov, Y. V. (2016), 'Estimating Trade Policy Effects With Structural Gravity', Geneva, World Trade Organization, WTO Working Paper ERSD-2016-10.
- Ramondo, N., Rodriguez-Claire, A. and Saborío-Rodríguez, M. (2014), 'Trade, Domestic Frictions, and Scale Effects', Cambridge, Massachusetts, National Bureau of Economic Research, NBER Working Paper No. 18532.
- Ravenstein, E. G. (1885) *The Laws of Migration: Part 2*. *Journal of the Royal Statistical Society* 52[2], 241-305.
- Redding, S. J. and Venables, A. J. (2004) *Economic Geography and International Inequality*. *Journal of International Economics* 62[1], 53-82.
- Rolleigh, M. M. (2013), 'Plant Heterogeneity and Applied General Equilibrium Models of Trade: Lessons From the Canada - U.S. Free Trade Agreement', unpublished, retrieved from [http://econ.williams.edu/files/trade\\_2013.pdf](http://econ.williams.edu/files/trade_2013.pdf).
- Romalis, J. (2007) *NAFTA's and CUSTA's Impact on International Trade*. *Review of Economics and Statistics* 89[3], 416-435.
- Samuelson, P. A. (1952) *The Transfer Problem and Transport Costs: The terms of Trade When Impediments Are Absent*. *Economic Journal* 62[246], 278-304.

- Santos Silva, J. M. C. and Tenreyro, S. (2006) *The Log of Gravity*. *The Review of Economics and Statistics* 88[4], 641-658.
- Santos Silva, J. M. C. and Tenreyro, S. (2011) *Further Simulation Evidence on the Performance of the Poisson Pseudo-Maximum Likelihood Estimator*. *Economics Letters* 112[2], 220-222.
- Shikher, S. (2012) *Predicting the Effects of NAFTA: Now We Can Do It Better!* *Journal of International and Global Economic Studies* 5[2], 32-59.
- Tinbergen, J. (1962), *Shaping the World Economy: Suggestions for an International Economic Policy*, New York: The Twentieth Century Fund.
- Trefler, D. (1993) *Trade Liberalization and the Theory of Endogenous Protection: an Econometric Study of U.S. Import Policy*. *Journal of Political Economy* 101[1], 138-160.
- Trefler, D. (2004) *The Long and the Short of the Canada-U.S. Free Trade Agreement*. *American Economic Review* 94[4], 870-895.
- Wei, S.-J. (1996), 'Intra-National Versus International Trade: How Stubborn Are Nations in Global Integration?', Cambridge, MA, National Bureau of Economic Research, NBER Working Paper No. 5531.
- Wooldridge, J. M. (2010), *Econometric Analysis of Cross Section and Panel Data*, 2nd Cambridge, MA: The MIT Press.
- World Trade Organization (WTO) (2015) *Speeding Up Trade: the Benefits and the Challenges of Implementing the WTO Trade Facilitation Agreement*, Geneva: WTO.
- Yotov, Y. V. (2012) *A Simple Solution to the Distance Puzzle in International Trade*. *Economics Letters* 117[3], 794-798.
- Zylkin, T. (2014), 'Not All Free Trade Agreements Have the Same Advantages', Philadelphia, LeBow College of Business, Drexel University, School of Economics Working Paper Series No. 2014-9.

Copyright © 2016 United Nations and World Trade Organization  
All rights reserved worldwide

All queries on rights and licenses, including subsidiary rights, should be addressed to:  
United Nations Publications, 300, East 42nd Street, New York, NY 10017, United States of America, e-mail: [publications@un.org](mailto:publications@un.org),  
website: [shop.un.org](http://shop.un.org)

United Nations publications can be obtained through major booksellers or from [shop.un.org](http://shop.un.org)

ISBN: 978-92-8-704367-2  
e-ISBN: 978-92-1-058519-4  
United Nations publication  
Sales No.: 16.II.D.8

*An Advanced Guide to Trade Policy Analysis* is a follow up to *A Practical Guide to Trade Policy Analysis*. The *Advanced Guide* provides the most recent tools for analysis of trade policy using structural gravity models. Written by experts who have contributed to the development of theoretical and empirical methods in the academic gravity literature and who have rich practical experience in the field, this publication explains how to conduct partial equilibrium estimations as well as general equilibrium analysis with structural gravity models and contains practical guidance on how to apply these tools to concrete policy questions.

This *Advanced Guide* has been developed to contribute to the enhancement of developing countries' capacity to analyse and implement trade policy. It is aimed at government experts engaged in trade negotiations, as well as graduate students and researchers involved in trade-related study or research.

