

United Nations Commission on Science and Technology for Development (CSTD)

**Ensuring safe water and sanitation for all: a solution by science,
technology and innovation**

Sergio I. Campos

**Water and Sanitation Division Chief
Inter-American Development Bank**

October 26, 2022





Report highlights

- Persistent challenge of universal access
 - Water Value Chain
 - Dimension of innovation
 - Knowledge generation
 - The 5 A's of technology access
 - Showcase of Innovation for the LDC
 - Policy Recommendations
- 

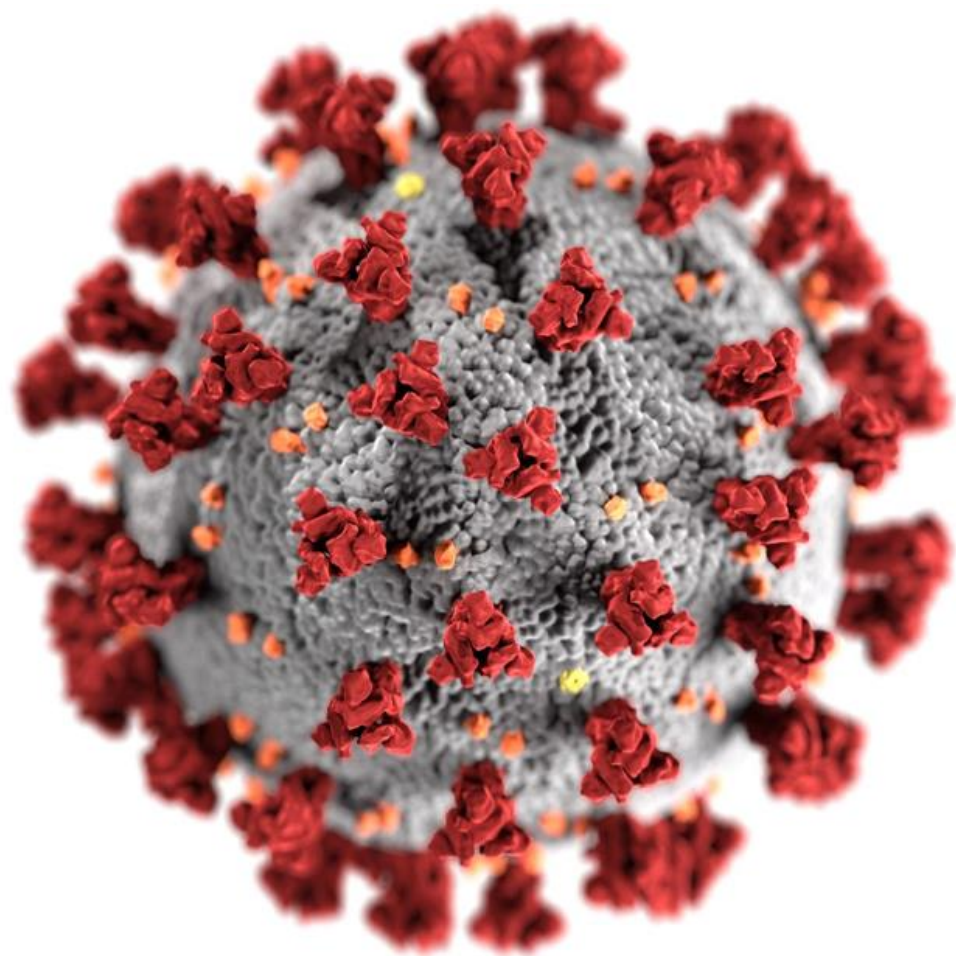







TRANSBOUNDARY WATERS



- **71% Surface water**
- **60% area**
- **40% Population**
- **40% Biodiversity**
- **SA- 38 TBB y CA- 29 TBB**



MOMO ELECTRONIC SHOP

BON PRI PROY ALIMENTA

GLOIP

MOMO ELECTRONIC SHOP

Cartes

Vitel

Digicel

Vodafone









72%

**Sourcing water for
human consumption**



INNOVACIÓN



Transformación digital

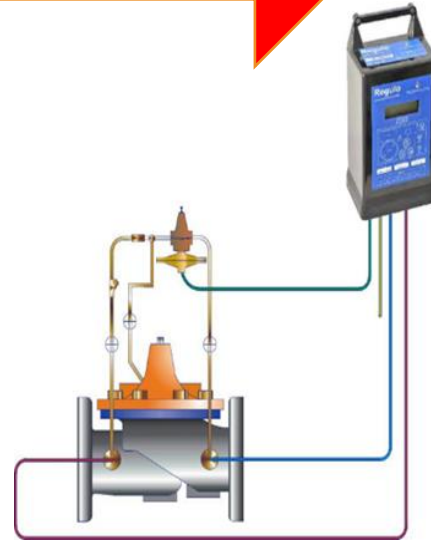
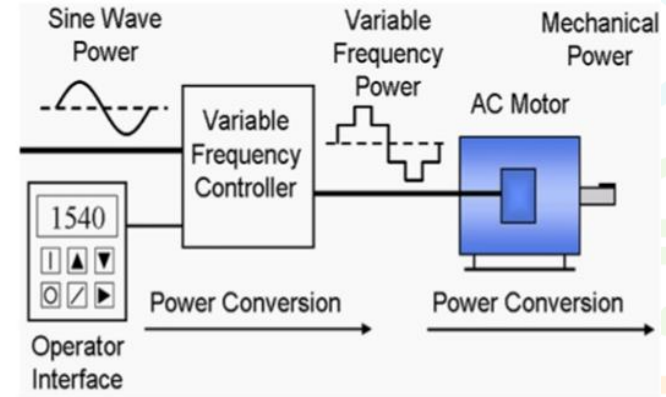
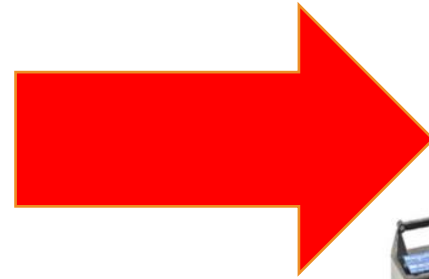
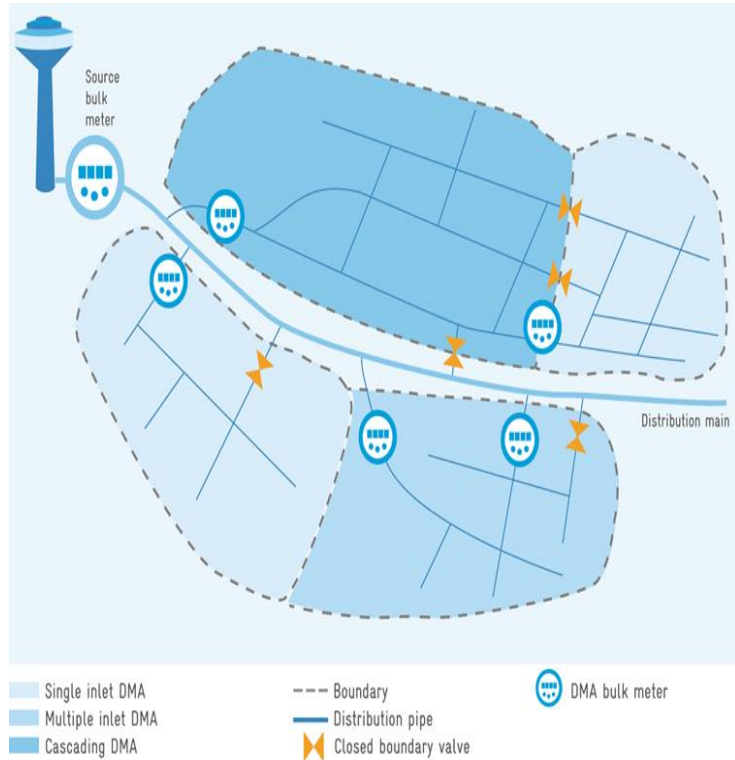





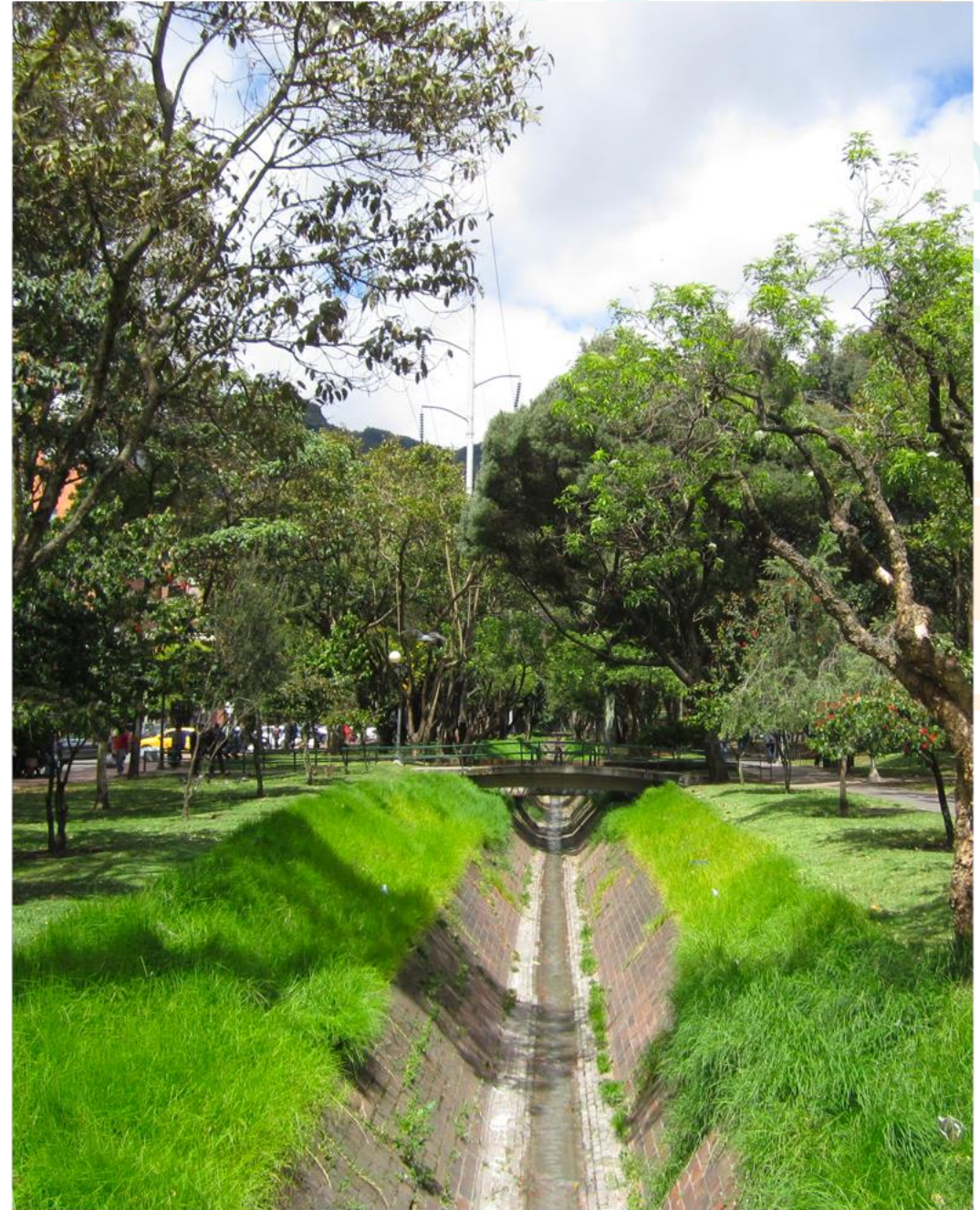

INVESTMENT IN WATER AND SANITATION INFRASTRUCTURE

0.34%
GDP

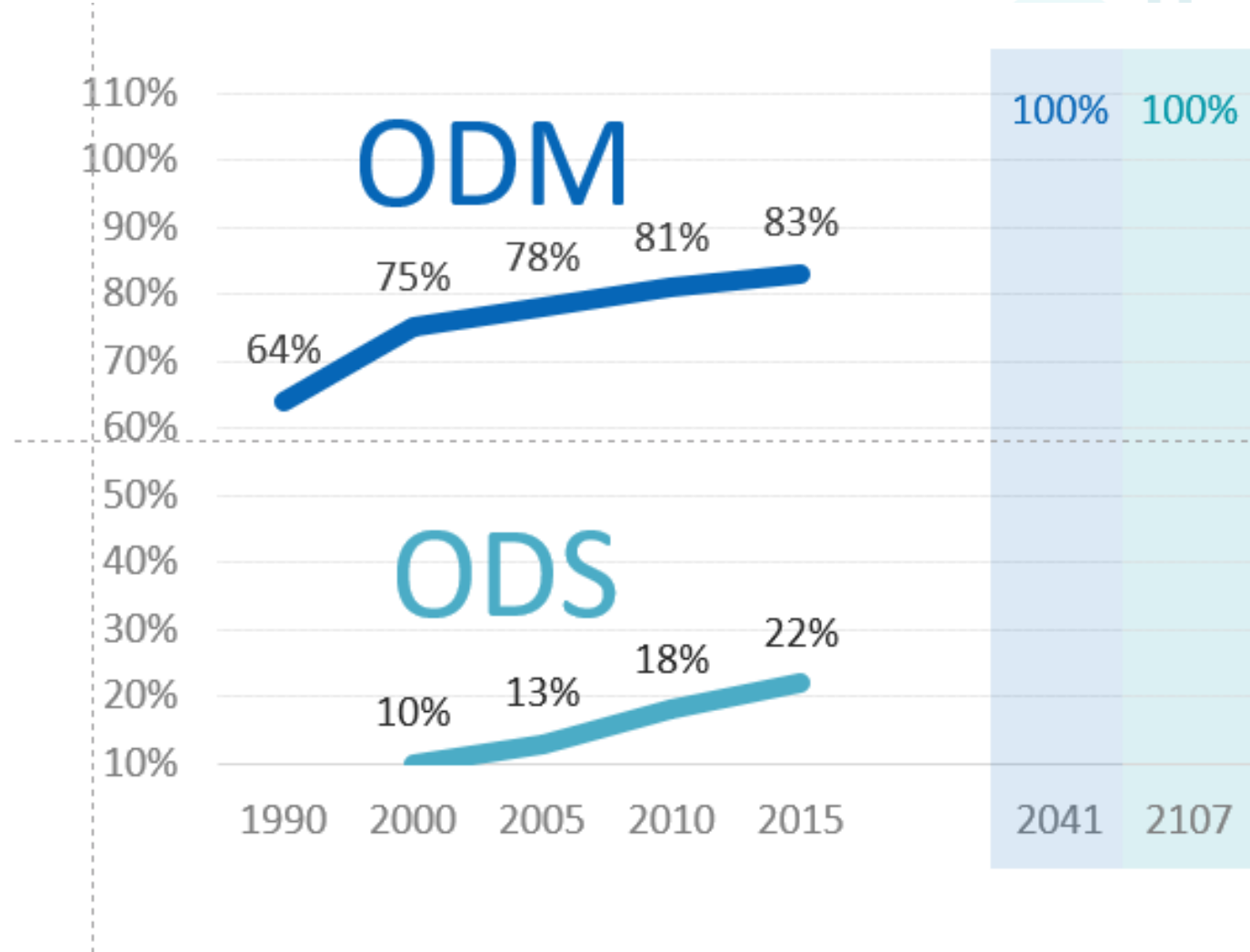



GOVERNANCE

New Normal

Pollution



Erosion



Biodiversity



Hydraulic
Cycle



Climate
Change



Swiss Re estimates that economic losses associated to climate change could reach up to US\$23 trillion by 2050

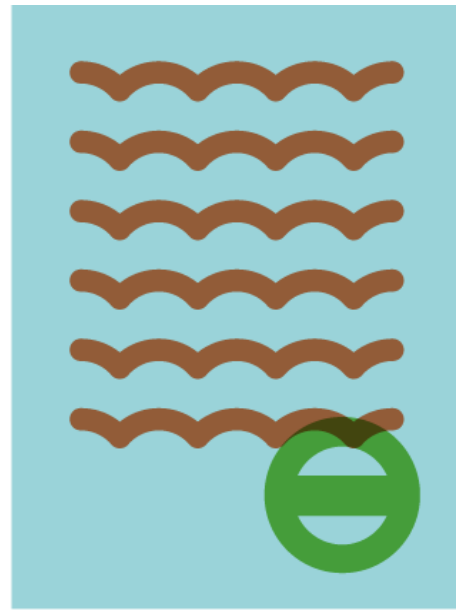
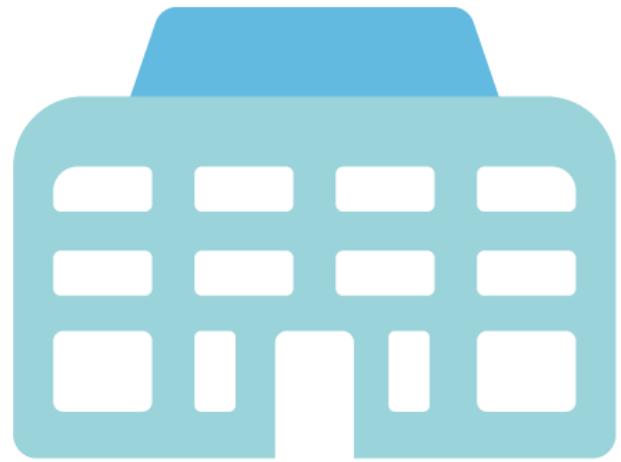

Local solutions to address global challenges



Hydro-BID

/// A tool for water resource management & planning ///
in Latin America and the Caribbean

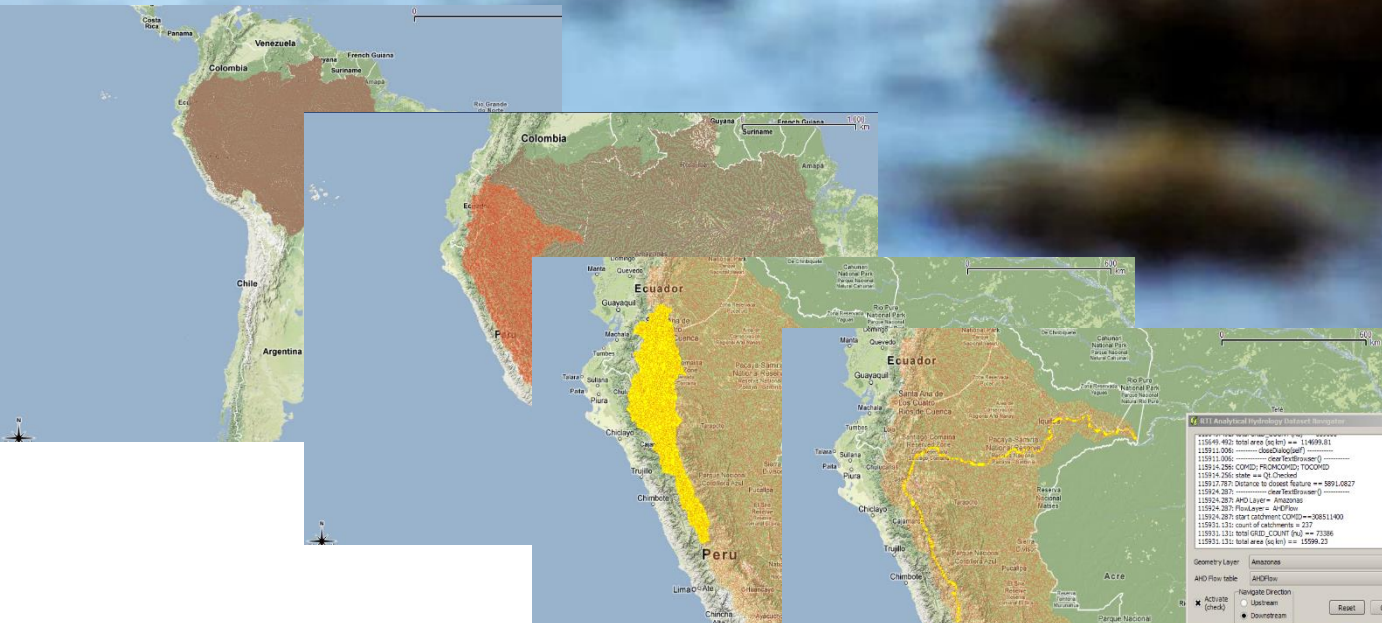

The Sanitation Initiative

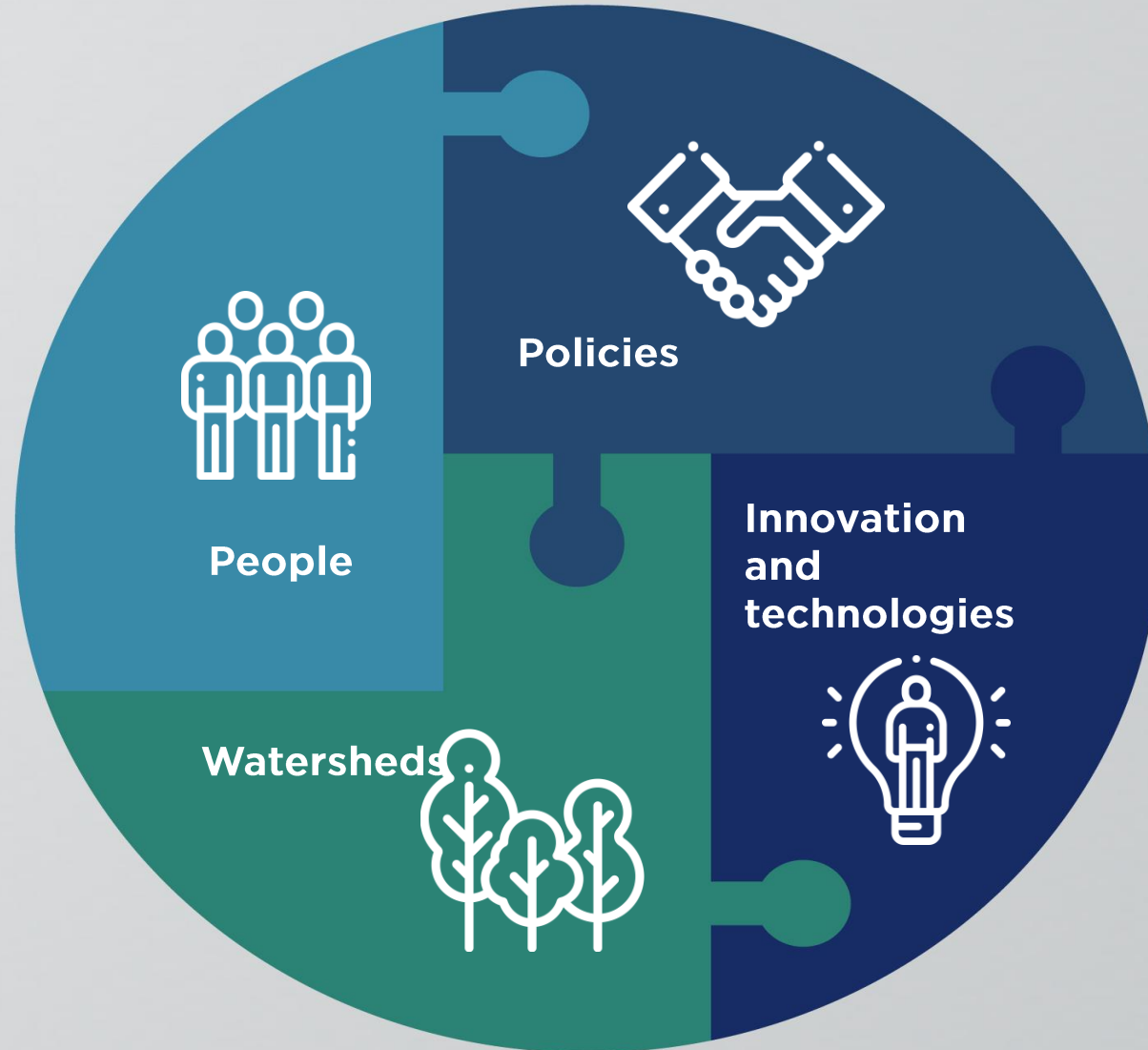



Indicators

- ▶ Best practices
- ▶ Information reliability

8 Evaluation areas | 28 Sub-areas
52 Groups of practices | 381 Individual practices

Service
Quality

Access to
Service

Business Managment
Efficiency

Operating
Efficiency

Efficiency in the Planning
and Execution of
Investments

Financial
Sustainability

Environmental
Sustainability

Corporate
Governance



LATIN AMERICAN WATER FUNDS PARTNERSHIP

- A financial **mechanism** for watershed conservation
- A **governance mechanism** for watershed planning
- An **implementation mechanism** for conservation activities

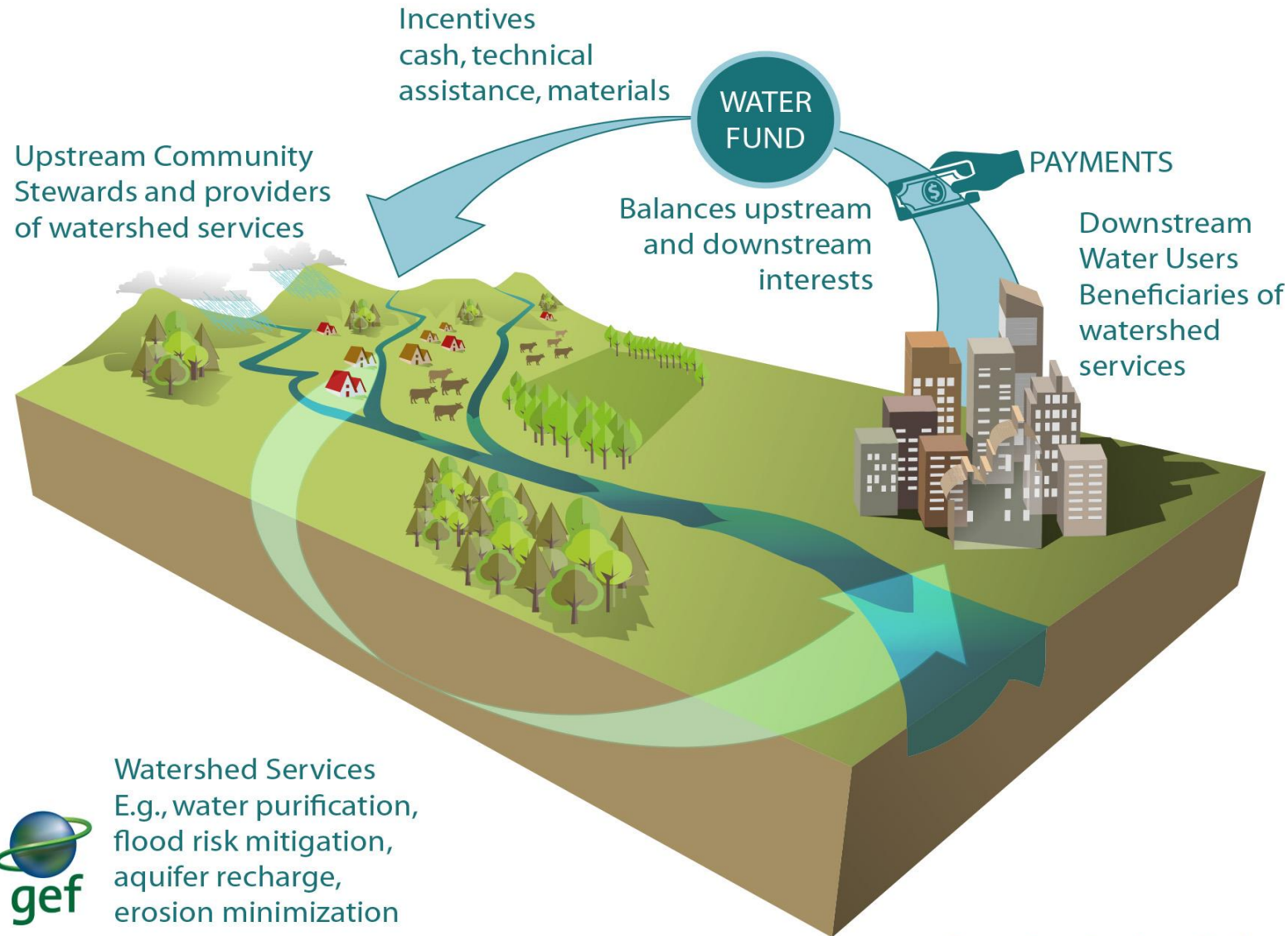

Source: Forest Trends; modified

OLAS

WATER AND SANITATION
OBSERVATORY FOR LATIN AMERICA
AND THE CARIBBEAN



Promote data
availability



Standardize
measurement
methods and
clarifying terminology



Show spatial
inequalities in the
region



FUENTE DE INNOVACIÓN



DONORS



CURRENT DONORS



Schweizerische Eidgenossenschaft
Confédération suisse
Confederazione Svizzera
Confederaziun svizra

Swiss Confederation

Federal Department of Economic Affairs,
Education and Research EAER
State Secretariat for Economic Affairs SECO

FUNDACIÓN
FEMSA



Ministry of Economy and
Industry of Israel
Foreign Trade Administration

POTENTIAL DONORS





e-hackathon en agua, saneamiento e higiene

11 y 12 de septiembre

<https://bidhackathon.creacion.camp>

¡Regístrate!

Tienes hasta el 14 de agosto



PREMIO IDEAS EN ACCIÓN

2020

Buscamos empresas prestadoras de servicios de agua y/o saneamiento en América Latina y el Caribe.

- Con **propuestas o modelos innovadores** que hayan sido implementados.
- Con **desafíos o problemáticas identificadas** que puedan ser solucionados a través de nuevas tecnologías.

Participan por:

Reconocimiento por BID a la empresa más innovadora de la región. Y además: promoción, visibilidad, difusión y asesoría.

Puedes aplicar hasta el 30 de Agosto en

www.premioideasenaccion.com

Si tienes dudas escríbenos a agua@iadb.org



PREMIO BID-FEMSA EDICIÓN ESPECIAL

A LA INNOVACIÓN EN AGUA, SANEAMIENTO Y RESIDUOS SÓLIDOS

¡Conoce a los finalistas!



AySA

Enlace

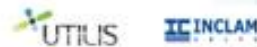



Thank You
