

Identification, Collection and Classification of Non-Tariff Measures (NTMs)

Mingcong Li
Trade Analysis Branch, UNCTAD

ASEAN In-Country Training
10-14 February 2020
Bandar Seri Begawan, Brunei
Kuala Lumpur, Malaysia



CONTENTS

- 1 Data collection and update process
- 2 Classification structure and key concepts
- 3 Case studies and group exercises
- 4 TRAINS online and other data dissemination tools



1

Data collection and update process



Work Flow of the Data Collection

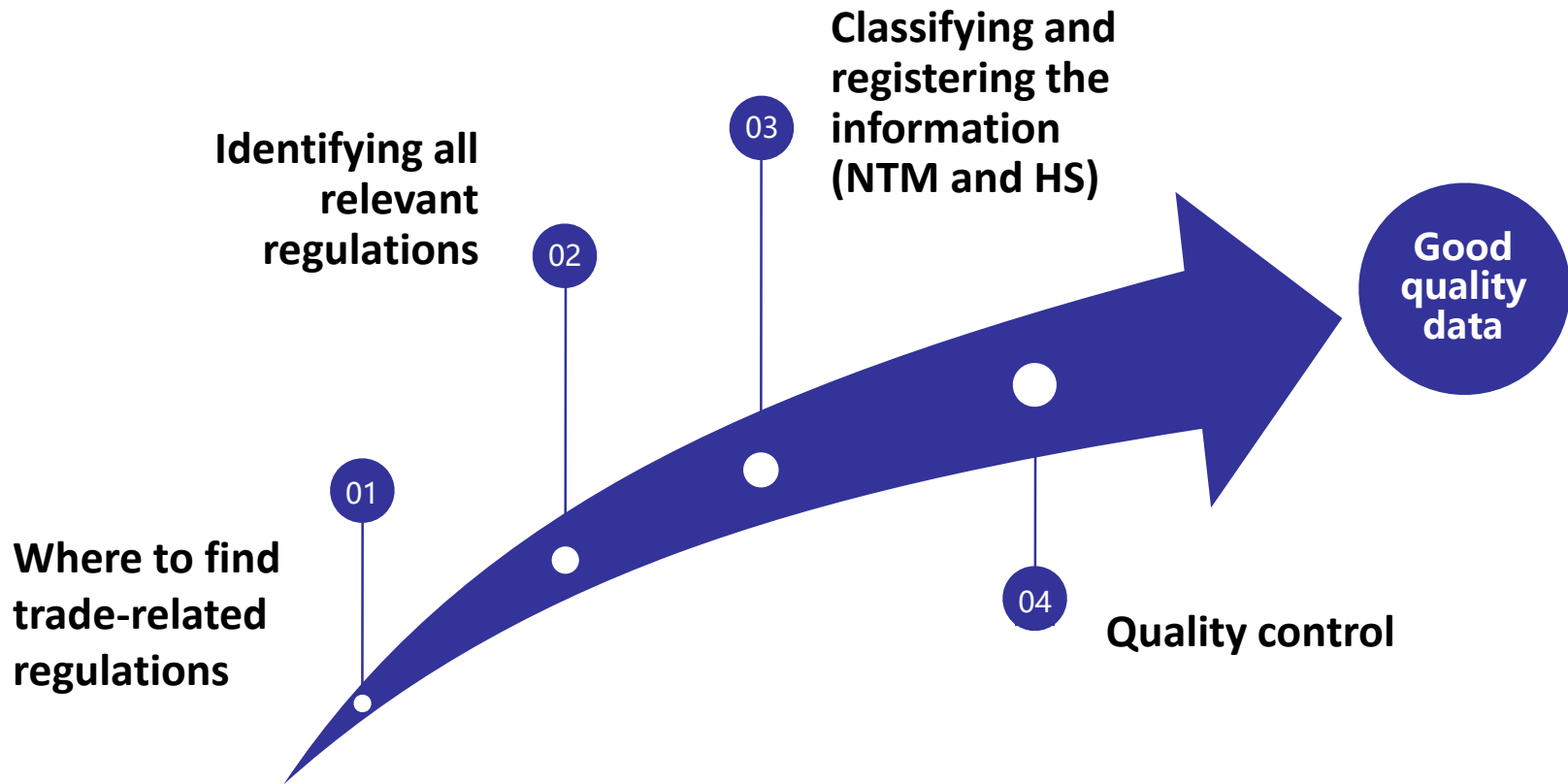

01 Comprehensiveness

- Identifying *all* trade-related regulations of a country is one of the biggest challenges of the data collection – but also one of the most important ones
- Every country has a different institutional framework
- Country-expertise is indispensable, no “one size fits all”-approach

Types of official sources:



Centralized sources/publications

Some countries compile and publish all their laws, regulations, acts, decrees, etc across all government institutions in one centralized publication

Decentralized sources

When a centralized source is missing, regulations need to be obtained from various ministries and institutions that regulate trade (*it is essential to obtain all regulations from each source*)



Other sources

Such as WTO notifications

(https://docs.wto.org/dol2fe/Pages/FE_Search/FE_S_S003.aspx),

WTO Trade Policy Reviews

(http://www.wto.org/english/tratop_e/tpr_e/tp_rep_e.htm)



01 Centralized Sources - Examples

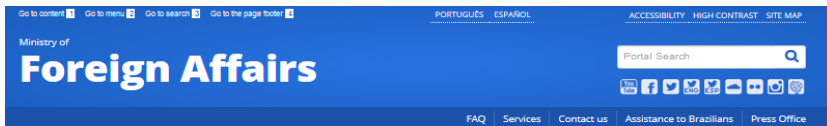

Consular Services

Invest&Export Brazil

Public Diplomacy

BrazilGovNews

DIPLOMATIC AND
CONSULAR MISSIONS

Brazilian missions
abroad

Foreign missions in
Brazil

The Latin American Integration Association (ALADI-LAIA)

The Latin American Integration Association (ALADI, its initials in Spanish) was created in 1980 to promote the economic and social development of the region, in a process of integration aiming at a gradual and progressive establishment of a common Latin American market. Currently, ALADI has as its members Argentina, Bolivia, Brazil, Chile, Colombia, Cuba, Ecuador, Mexico, Panama, Paraguay, Peru, Uruguay, and Venezuela. Nicaragua is in the process of accession. The group of 13 members of ALADI covers an area of 20 million km² (nearly five times greater than the area of the 28 countries that comprise the European Union), approximately 530 million inhabitants and a GDP above US\$ 5 trillion.

ALADI is the result of a process of regional integration which started at the end of the 1950s, the first milestone being the establishment of the Latin American Free Trade Association (LAFTA) in 1960. LAFTA was a relatively strict mechanism because it required that any trade concession from a member country to another would be immediately and automatically extended to the others - "the most favored nation clause". This model did not provide the expected gains.

ALADI (Association for Latin American Integration)

Official journals / gazettes that centralize the publishing of laws across all government institutions



National Archives and Records Administration

code of
federal regulations

United States of America

- Code of Federal Regulations (CFR) is an annual publication stating the currently applied law
- Federal Register (FR) is a daily journal which published any changes to the current law



01 Decentralized Sources: Examples

NTM Chapter		Potential responsible Government Bodies
A	Sanitary and Phytosanitary Measures (SPS)	Ministry of Agriculture; Standardization Agency, Ministry of Health, Customs Agency.....
B	Technical Barriers to Trade (TBT)	Standardization Agency; Ministry of Health; Ministry of Ecology; Ministry of Industry; Ministry of Commerce
C	Pre-shipment Inspection and other formalities	Customs Agency, Standardization Agency
D	Contingent Trade Protective Measures	Ministry of Finance; Ministry of Economy, Industry or Trade; Customs Agency
E	Non-Automatic Licensing, Quotas, Prohibitions and Other Quantity Control Measures	Ministry of Economy, Industry or Trade; Customs Agency
F	Price Control Measures Including Additional Taxes and Charges	Ministry of Economy, Industry or Trade; Customs Agency
G	Finance measures	Ministry of Finance; National Bank
H	Measures Affecting Competition	Ministry of Economy, Industry or Trade
I	Trade-related investment measures	Ministry of Economy, Industry or Trade
P	Export-related measures	Ministry of Economy, Industry or Trade; Standardization Agency; Ministry of Agriculture; Customs Agency

01 Mapping Legal Comprehensiveness

All ministries, departments and subsidiary agencies checked

Act/regulation that are trade-related (with url link or electronic copies provided)

Status of the regulation (i.e. unchanged, replaced, amended, repealed, missing) → important for the updating of data

A	B	C	D	E	F	G	H	I	J	K	L	M	N	O	P	Q
	Country	Ministry	Department	Subsidiary agency	Check?	Trade-related	Link of Ministry/Agency	Document	Regulation	Link of Regulations	Check	Trade-Related	Coded	Notes	Year of Amendment/Version of Regulation	
1	Singapore	Ministry of National Development	Agri-Food and Veterinary Authority		1	1	www.ava.gov.sg/	Animals and Birds Act (CHAPTER 7)	Animals and Birds Act (CHAPTER 7)	https://sso.agc.gov.sg/Act	1	1	1	Amended by Act 48 of 2017	2017	
2	Singapore	Ministry of Home Affairs	Singapore Police Forces		1	1	https://www.police.gov.sg/	Arms and Explosives Act	Arms and Explosives (Arms) Rules	https://sso.agc.gov.sg/SL/	1	1	1	Amended by S 173/2017	2017	
3	Singapore	Ministry of Home Affairs	Singapore Police Forces		1	1	https://www.police.gov.sg/	Arms and Explosives Act	Arms and Explosives (Explosives) Rules	https://sso.agc.gov.sg/SL/	1	1	1	Amended by S 174/2017	2017	
4	Singapore	Ministry of Health	Health Science Authority		1	1	www.hsa.gov.sg/	Biological Agents and Toxins Act (Chapter 50A)	Biological Agents and Toxins Act (Chapter 50A)	https://sso.agc.gov.sg/Act	1	1	1	Amended by S 852/2017	2017	
5	Singapore	Ministry of Trade and Industry	Singapore Standards Board (PSB)		1	1	https://www.mti.gov.sg	Consumer Protection (Safety Requirements) Regulations	Consumer Protection (Safety Requirements) Regulations	https://sso.agc.gov.sg/SL/	1	1	1	Amended by S 14/2018	2018	
6	Singapore	Ministry of Finance	Singapore Customs Authority		1	1	https://www.customs.gov.sg/	Customs Act (Chapter 70)	Customs (Motor Vehicles Special Taxation) Regulations	https://sso.agc.gov.sg/SL/	1	1	1	Amended by S 53/2017	2017	
7	Singapore	Ministry of Finance	Singapore Customs Authority		1	1	https://www.customs.gov.sg/	Customs Act (Chapter 70)	Customs Regulations	https://sso.agc.gov.sg/SL/	1	1	1	Amended by S 56/2017	2017	
8	Singapore	Ministry of Trade and Industry	Economic Development Board		1	1	https://www.edb.gov.sg/	Economic Expansion Incentives (Relief) Regulations	Economic Expansion Incentives (Relief) Regulations	https://sso.agc.gov.sg/Act	1	1	1	Amended by Act 33 of 2017	2017	
9	Singapore	Ministry of Trade and Industry	Energy Market Authority of Singapore		1	1	https://www.ema.gov.sg/	Electricity Act (Chapter 8)	Electricity (Electrical Installations) Regulations	https://sso.agc.gov.sg/SL/	1	1	1	Amended by S 355/2018	2018	
10	Singapore	Ministry of National Development	Agri-Food and Veterinary Authority		1	1	www.ava.gov.sg/	Endangered Species (Import and Export) Regulations	Endangered Species (Import and Export) Regulations	https://sso.agc.gov.sg/Act	1	1	1	Amended by S 103/2016, Amended by S 103/2016, Amended by S 535/2016, Amended by S 131/2016, Amended by S 155/2017, Amended by S 563/2017	2017	
11	Singapore	Ministry of the Environment and Water Resources	National Environment Agency		1	1	www.nea.gov.sg/	Energy Conservation Act	Energy Conservation (Fuel Economy Labels) Regulations	https://sso.agc.gov.sg/SL/	1	1	1	Amended by S 175/2017	2017	
12	Singapore	Ministry of the Environment and Water Resources	National Environment Agency		1	1	www.nea.gov.sg/	Energy Conservation Act	Energy Conservation (Registable Goods) Order 2013		1	1	1	has been revoked	2013	
13	Singapore	Ministry of the Environment and Water Resources	National Environment Agency		1	1	www.nea.gov.sg/	Energy Conservation Act	Energy Conservation Act (Chapter 32C)	https://sso.agc.gov.sg/Act	1	1	1	Amended by Act 30 of 2017	2017	
14	Singapore	Ministry of the Environment and Water Resources	National Environment Agency		1	1	www.nea.gov.sg/	Energy Conservation Act	ENERGY CONSERVATION (GREENHOUSE GAS MEASUREMENT AND REPORTING) REGULATIONS	https://sso.agc.gov.sg/SL/	1	1	0	SL 746/2017	2017	
15	Singapore	Ministry of the Environment and Water Resources	National Environment Agency		1	1	www.nea.gov.sg/	Energy Conservation Act	ENERGY CONSERVATION (REGULATED GOODS AND REGISTERED SUPPLIERS) REGULATIONS	https://sso.agc.gov.sg/SL/	1	1	0	SL 749/2017	2017	
16	Singapore	Ministry of the Environment and Water Resources	National Environment Agency		1	1	www.nea.gov.sg/	Energy Conservation Act	ENERGY CONSERVATION (MOTOR VEHICLES) REGULATIONS	https://sso.agc.gov.sg/SL/	1	1	0	Amended by S 382/2018	2018	
17	Singapore	Ministry of the Environment and Water Resources	National Environment Agency		1	1	www.nea.gov.sg/	Energy Conservation Act	ENERGY CONSERVATION (PRESCRIBED REGULATED GOODS) REGULATIONS	https://sso.agc.gov.sg/SL/	1	1	0	SL 747/2017	2017	
18	Singapore	Ministry of the Environment and Water Resources	National Environment Agency		1	1	www.nea.gov.sg/	Energy Conservation Act	ENERGY CONSERVATION (GREENHOUSE GAS MEASUREMENT AND REPORTING) REGULATIONS	https://sso.agc.gov.sg/SL/	1	1	0	No. S 746	2017	
19	Singapore	Ministry of the Environment and Water Resources	National Environment Agency		1	1	www.nea.gov.sg/	Environmental Protection and Management Act	Environmental Protection and Management Act	https://sso.agc.gov.sg/SL/	1	1	1	Amended by S 782/2017	2017	
20	Singapore	Ministry of the Environment and Water Resources	National Environment Agency		1	1	www.nea.gov.sg/	Environmental Protection and Management Act	Environmental Protection and Management Act	https://sso.agc.gov.sg/SL/	1	1	1	Amended by S 372/2016, Amended by S 25/2017, Amended by S 480/2017, Amended by S 396/2017, Amended by S 480/2017, Amended by S 781/2017, Amended by S 781/2017, Amended by S 183/2018	2018	
21	Singapore	Ministry of the Environment and Water Resources	National Environment Agency		1	1	www.nea.gov.sg/	Environmental Protection and Management Act	Environmental Protection and Management Act	https://sso.agc.gov.sg/SL/	1	1	1	Amended by Act 4 of 2016, Amended by S 378/2016, Amended by S 263/2016, Amended by S 27/2017, Amended by Act 24 of 2017, Amended by S 126/2017, Amended by S 783/2017, Amended by S 486/2018	2018	
22	Singapore	Ministry of Communications and Information	Info-Communications Media Development Authority		1	1	https://www.imda.gov.sg/	Films Act (Chapter 107)	Films (Fees) Regulations	https://sso.agc.gov.sg/SL/	1	1	1	Amended by S 486/2018	2018	



02 Classification's Scope of NTMs

All regulations that are:

Currently applied

01

Affecting
international
trade

02

Official and
mandatory

03

Detailed and specific

04



Examples: Identifying NTM-Related Regulations

The production, import, export and trade of pharmaceutical for the veterinary, shall be determined by a joint prakas (joint proclamation) of the Ministry of Health and the Ministry of Agriculture, Fishery and Forestry

Source: Amendment of the Law on the Management of Pharmaceuticals of Cambodia (2007)



Importation of plants and related plant products capable of harboring plant pests must be accompanied by a Phytosanitary or Health Certificate issued by the Plant Quarantine Service or its equivalent technical entity in the country of origin stating among others that the materials are free from pests.

Source: BPI Quarantine Administrative Order No. 01 series of 1981 (Philippines)



03 Steps in Registering NTMs Information

Registering the origin of the data in a systematic way is important

- To make the information traceable for users
- To enable future updates
- To enable quality checking



Source_Name	NZ Legislation website, www.legislation.govt.nz
DocumentTitle	Electricity Act 1992
RegulationTitle_Short	Electricity (Safety) Regulations 2010
Regulatory_Agency	Ministry of Business, Innovation and Employment
Web link	www.legislation.co.nz/regulation/public/2010/0036/latest/DLM2763501.html

03 Steps in registering NTMs information

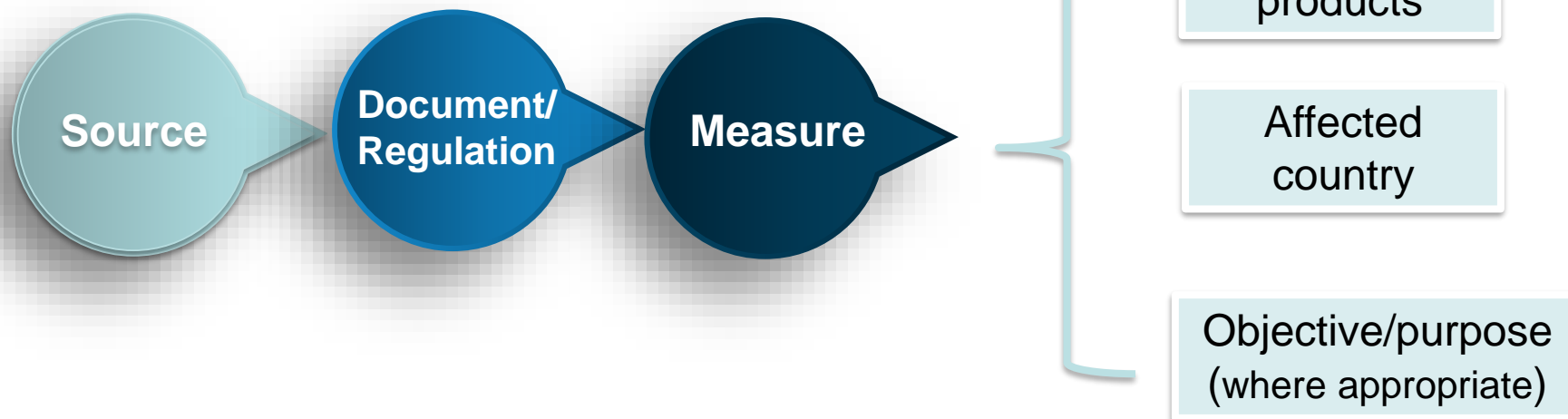

Measure id	Document Title	Regulation Title Short	NTM M4 Code	Measure Implementation Date	Measure Repealed Date	Measure Description	Measure Reference	Affected Products Description	Affected Regions Description	Measure Objectives	Measure also domestic	Notes
175111	Ministry of Public Health's ministerial notice on blood bag, 2013	Ministry of Public Health's ministerial notice on blood bag, 2013	B7	2014-02-19	2016-04-05	Blood bags need to have standard and regulation following Ministry of Industry's ministerial notice on industrial product standard of sterilized plastic for containing blood and its ingredient (TIS 1298-2555).	Page 1, item 4	Blood bags	World	For controlling medical devices and conforming to international standard of controlling	Yes	TIS stands for Thailand In Standard.
175112	Ministry of Public Health's ministerial notice on blood bag, 2013	Ministry of Public Health's ministerial notice on blood bag, 2013	B41	2014-02-19	2016-04-05	Blood bags shall be manufactured by a manufacturer who obtains certification for manufacturing quality for such product in accordance with the national standard or international standard such as GMP, ISO 13485.	Page 1, item 5	Blood bags	World	For controlling medical devices and conforming to international standard of controlling	Yes	
175113	Ministry of Public Health's ministerial notice on blood bag, 2013	Ministry of Public Health's ministerial notice on blood bag, 2013	B14	2014-02-19	2016-04-05	Blood bags shall be medical devices which manufacturers or importers need to get a license following Ministry of Public Health's ministerial regulation on permission and issuance of license to import medical devices, 2012. This regulation indicates that any person who has registered a place of establishment for importing medical devices and testing of blood bags shall be in line with industrial product standard (TIS 1298). A drawn sample and consideration criteria of blood bag shall be in accordance with the standard of industrial product. A licensee to manufacture or import blood bags shall collect a sample of blood bags for each model manufactured or imported in packaging of blood bag need to have label in Thai or English and shall display, at least, the followings:	Page 1, item 2	Blood bags	World	For controlling medical devices and conforming to international standard of controlling	Yes	Ministry of Public Health's ministerial regulation on permission and issuance of license to import medical 2012. Link: http://news.rfd.moh.go.th
175114	Ministry of Public Health's ministerial notice on blood bag, 2013	Ministry of Public Health's ministerial notice on blood bag, 2013	B82	2014-02-19	2016-04-05	consideration criteria of blood bag shall be in accordance with the standard of industrial product. A licensee to manufacture or import blood bags shall collect a sample of blood bags for each model manufactured or imported in packaging of blood bag need to have label in Thai or English and shall display, at least, the followings:	Page 1, item 6	Blood bags	World	For controlling medical devices and conforming to international standard of controlling	Yes	TIS stands for Thailand In Standard.
175115	Ministry of Public Health's ministerial notice on blood bag, 2013	Ministry of Public Health's ministerial notice on blood bag, 2013	B31	2014-02-19	2016-04-05	(1) Name and trademark; (2) Net amount; (3) Number or letter illustrating the lot number or model; (4) Month and year of expired.	Page 2, item 8	Blood bags	World	For controlling medical devices and conforming to international standard of controlling	Yes	

Distinguish a "Measure" with a "Regulation"

- Regulation → Law, decree, etc. issued officially by a government
- Measure { → Mandatory trade control requirement enacted through such an official regulation
- One official regulation could bear several NTM

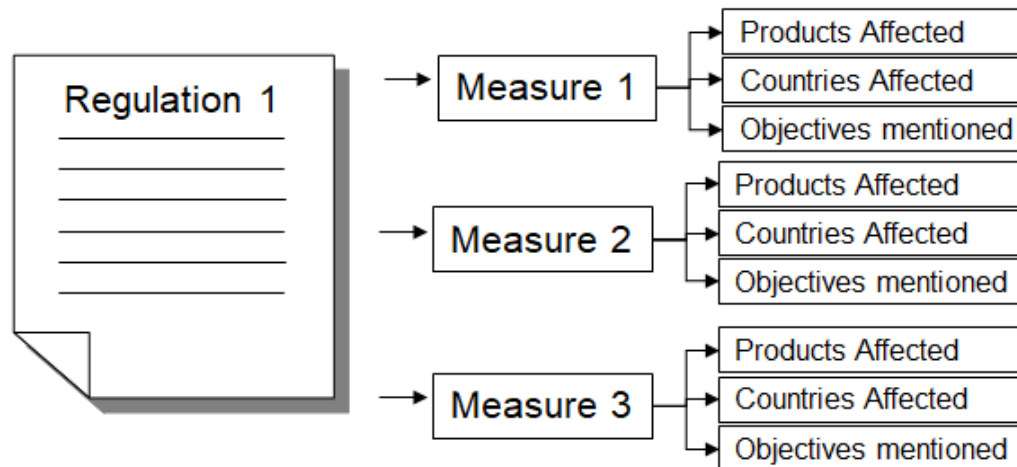

Key Principles for Registering NTMs

Global comparable and comprehensive database

Reflects the reality as much as possible

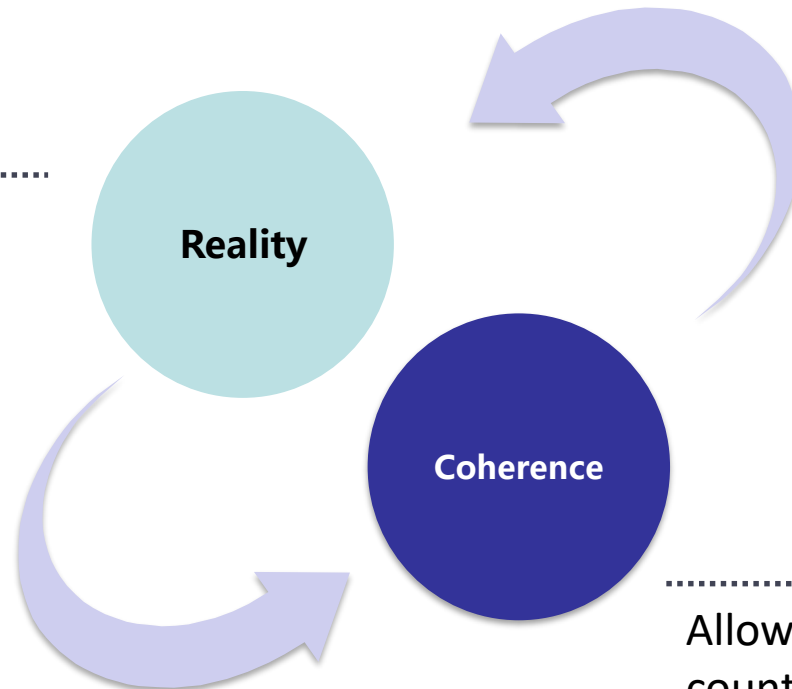

Allows for comparisons across countries, since procedures for data collection are the same



NTM Data Update in ASEAN

• Data

- ❖ Collected at the reporter-year-partner-product – NTM level
- ❖ All trade regulations that were **in force up to March 30, 2018**
- ❖ Include bilateral NTMs and measures applied to the whole world
- ❖ Products are defined for all 10 countries at the **ASEAN Harmonized Tariff Nomenclature (AHTN 2017) at the 8-digit level**

• Methodology

- ❖ Understand legal system of the country (hierarchy of laws and regulations)
- ❖ Identify agencies/institutions issuing trade-related regulations (sources)
- ❖ Collect trade-related regulations from identified agencies (based on the 4 principles)
- ❖ Compare with previously collected data and check for **amendments/newly issued regulations/peals**.
- ❖ Record all changes including **amendments, repeals and newly issued** NTMs in UNCTAD's database





2

Classification structure and key concepts



Structure of Classification (NTMs affecting trade)

Import Measures

Technical Measures

Non-Technical Measures

Export Measures

Technical Measures

Non-Technical Measures

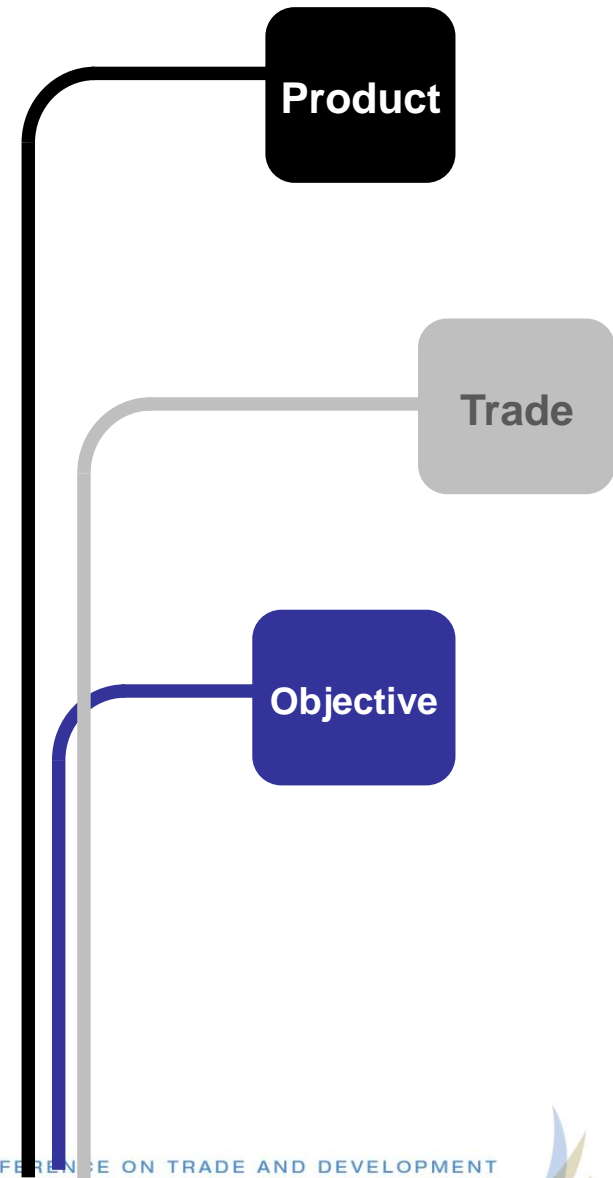

Structure of Classification

Import measures	Technical Measures	A SPS B TBT C Pre-shipment inspection and other formalities
	Non-Technical Measures	D Contingent trade-protective measures E Non-automatic licenses, quotas, prohibitions, quantity-control F Price-control measures, taxes and charges G Financial measures H Measures affecting competition I Trade-related Investment measures
		J Distribution Restrictions K Restrictions on Post-Sales Services L Subsidies M Government Procurement restrictions N Intellectual Property O Rules Of Origin
Export measures		P Export-related Measures



Tree Structure

- Each individual chapter (one digit, letter A-P) is divided into groupings using a tree/branch structure with depth of up to three additional levels (2, 3, and 4 numerical digits).
- More digits indicate more disaggregation – more detailed measure categories.

Tree structure -- for example:

A Sanitary and Phytosanitary (SPS) measures
A1 Prohibitions/restrictions of imports for SPS reasons
 A11 Temporary geographic prohibition
 (...)
A2 Tolerance limits for residues and restricted use of substances
 (...)
A3 Labeling, marking, packaging requirements
 (...)
A4 Hygienic requirements
 (...)
A5 Treatment for the elimination of pests and diseases
 A51 Cold/heat treatment
 A52 Irradiation
 (...)
A6 Requirements on production/post-production processes
 (...)
A8 Conformity assessment
 A81 Product registration
 A82 Testing requirement
 A83 Certification requirement
 A84 Inspection requirement
 A85 Traceability requirement
 A851 Origin of materials and parts
 A852 Processing history
 (...)
A88 Quarantine requirement
A89 Other conformity assessments



SPS and TBT: The Differences

SPS measures

10%

- Ensure that **food is safe** for consumers
- Prevent the **spread of pests/diseases** among animals, plants or humans

TBT measures

70%

Standards or mandatory requirements on **product characteristics** or their related **processes or production methods**, including technical regulations, testing and certification procedures



SPS and TBT Objectives: Decision-Making Diagram

Not differentiated through objective!

Food safety, pests, diseases

SPS

Objective of protecting human, animal & plant life or health, or a country from the risks of:

- the entry, establishment or spread of **pests, diseases**, diseases carrying or causing **organisms**;

- **additives, toxins, contaminants** of disease-causing organisms **in food, beverages, or feedstuffs**

- **diseases** carried by animals, pests or plants or products thereof;

YES

SPS

No

Does the measure lay down mandatory requirements either on:

- Product characteristics
- Production processes or methods
- Conformity assessment

To fulfil an objective of protecting *inter alia*

TBT

Human life/health
Occupational health hazards

Environment
Endangered species
Emissions levels

Consumers
Prevention of deceptive practices

Other
Quality, national security, technical harmonization

No

Others

Probably, **chapter E**

(e.g. licenses, permits, quotas and other quantitative restrictions)

YES

TBT

UNITED NATIONS CONFERENCE ON TRADE AND DEVELOPMENT

UNCTAD

Technical Regulations: Important Principles

01

There is no overlap in coverage between the SPS and TBT agreement, it is possible that the same regulation contains both SPS and TBT measures for different requirements, but not possible for one requirement to have both SPS and TBT at the same time (**only exception is labelling requirement**).

02

Neither SPS nor TBT are defined according to product coverage **alone**. It shall be defined by the **objective of the measure plus affected product**.



SPS and TBT: Simple Examples

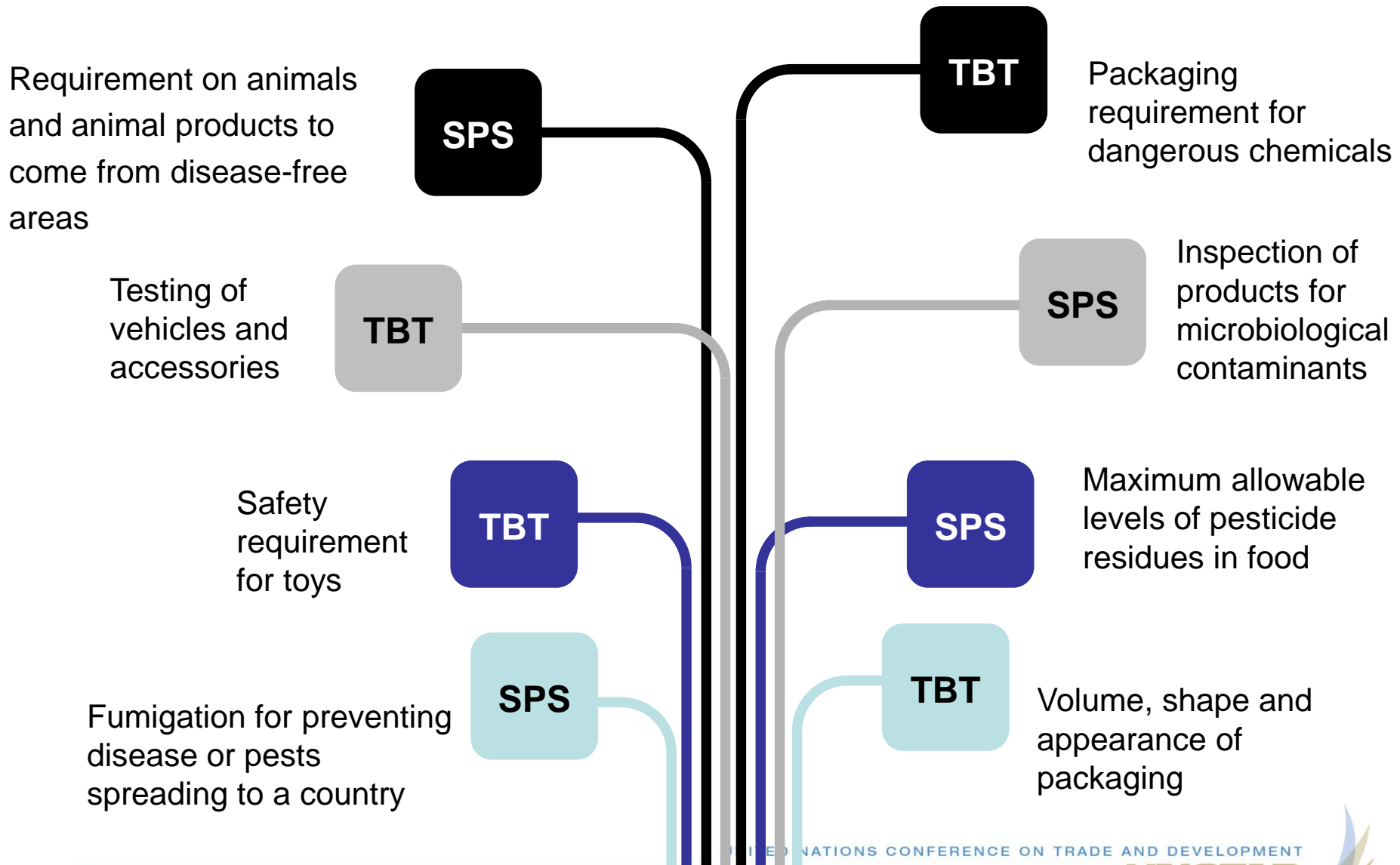

Other Chapters

Import measures	Technical Measures	A SPS B TBT C Pre-shipment inspection and other formalities
	Non-Technical Measures	D Contingent trade-protective measures E Non-automatic licenses, quotas, prohibitions, Quantity-control F Price-control measures, taxes and charges G Financial measures H Measures affecting competition I Trade-related Investment measures J Distribution Restrictions K Restrictions on Post-Sales Services L Subsidies M Government Procurement restrictions N Intellectual Property O Rules Of Origin
Export measures		P Export-related Measures



Other Chapter: C Pre-shipment Inspection

C	Pre-shipment Inspection
C1	Pre-shipment inspection
C2	Direct consignment (no 3rd country)
C3	Requirement to pass through specified port of customs
C4	Automatic licensing (monitoring and surveillance)
C9	n.e.s



Other Chapters: D - I

D	Contingent trade-protective measures <i>- Antidumping, countervailing, safeguards</i>
E	Non-automatic licenses, quotas, prohibitions, etc. <i>- Non-automatic licenses (other than SPS or TBT), quotas , prohibitions, Voluntary Export restriction (VER), Tariff rate quotas</i>
F	Price-control measures, taxes and charges <i>- Minimum prices, reference prices, Voluntary export-price restraints (VEPRs), taxes, charges, fees</i>
G	Financial measures <i>- Multiple exchange rates, foreign exchange restrictions, advance payments for imported goods or tariffs</i>
H	Measures affecting competition <i>- State-trading enterprises, Compulsory use of national services or insurance or transport</i>
I	Trade-related Investment measures <i>- Local content, Trade-balancing, that limit imports or requires certain levels of exports to compensate</i>



Other Chapters: J-O

J	Distribution restrictions <i>- on distribution restrictions, describes restrictive measures related to the internal distribution of imported products.</i>
K	Restrictions on post-sales services <i>- deals with restrictions on post-sales services, for example restrictions on the provision of accessory services.</i>
L	Subsidies and other forms of support <i>- contains measures that relate to the subsidies that affect trade</i>
M	Government procurement restrictions <i>- on government procurement restrictions, describes the restrictions bidders may find when trying to sell their products to a foreign government.</i>
N	Intellectual property <i>- contains restrictions related to intellectual property measures and rights.</i>
O	Rules of origin <i>- on rules of origin, groups the measures that restrict the origin of products or its inputs.</i>

* Chapter J-O is not actively collected before the launch of the new "International Classification on NTMs" (2019)



Other Chapters: P Export Measures

P	Export measures
P1	Export measures related to sanitary and phytosanitary measures and technical barriers to trade
P2	Export formalities
P3	Export licences, export quotas, export prohibition and other restrictions other than sanitary and phytosanitary or technical barriers to trade measures
P4	Export price-control measures, including additional taxes and charges
P5	State-trading enterprises, for exporting; other selective export channels
P6	Export-support measures
P7	Measures on re-export
P9	Export measures, n.e.s



P Export Measures

Parallel to chapters of import measures

P13: production and post-production requirements to export

- Hygienic requirements related to SPS (see example in A4)
- Treatment for elimination of plant and animal pests and disease-causing organisms in the final products (e.g. post-harvest treatment) or prohibition of treatment (see examples in A5)
- Other requirements on production or post-production processes related to SPS (see examples in A6)
- Production or post-production processes related to TBT (see examples in B4)



3

Case studies and group exercises



Case Study 1: Measures on SPS

Revised Rules, Regulations and Standards Governing the Importation of Meat and Meat Products into the Philippines (2005)

What are the measures imposed on importers to import meat and related products into Philippines?



Case Study 2: Measures on TBT

Regulation Regarding Medical Devices and Household Products (2010)

Affected product: Medical Devices and Household Products

Affected region: the whole world

What measures do importers need to fulfill?

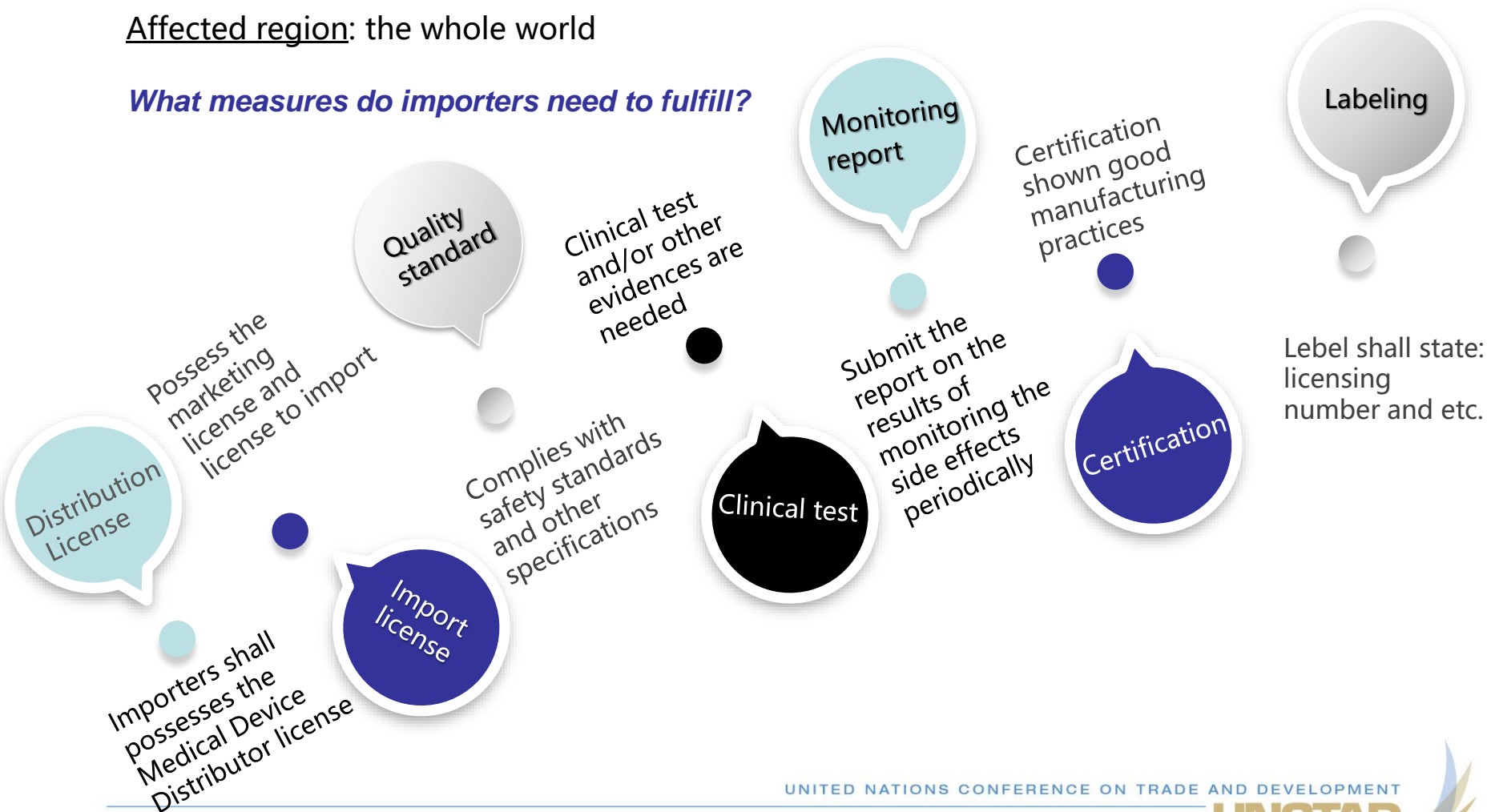

4

NTM data entry using TRAINS Online Tool and other dissemination tools



Introduction to TRAINS Online Tool

Issues for using excel template to enter information on NTMs:

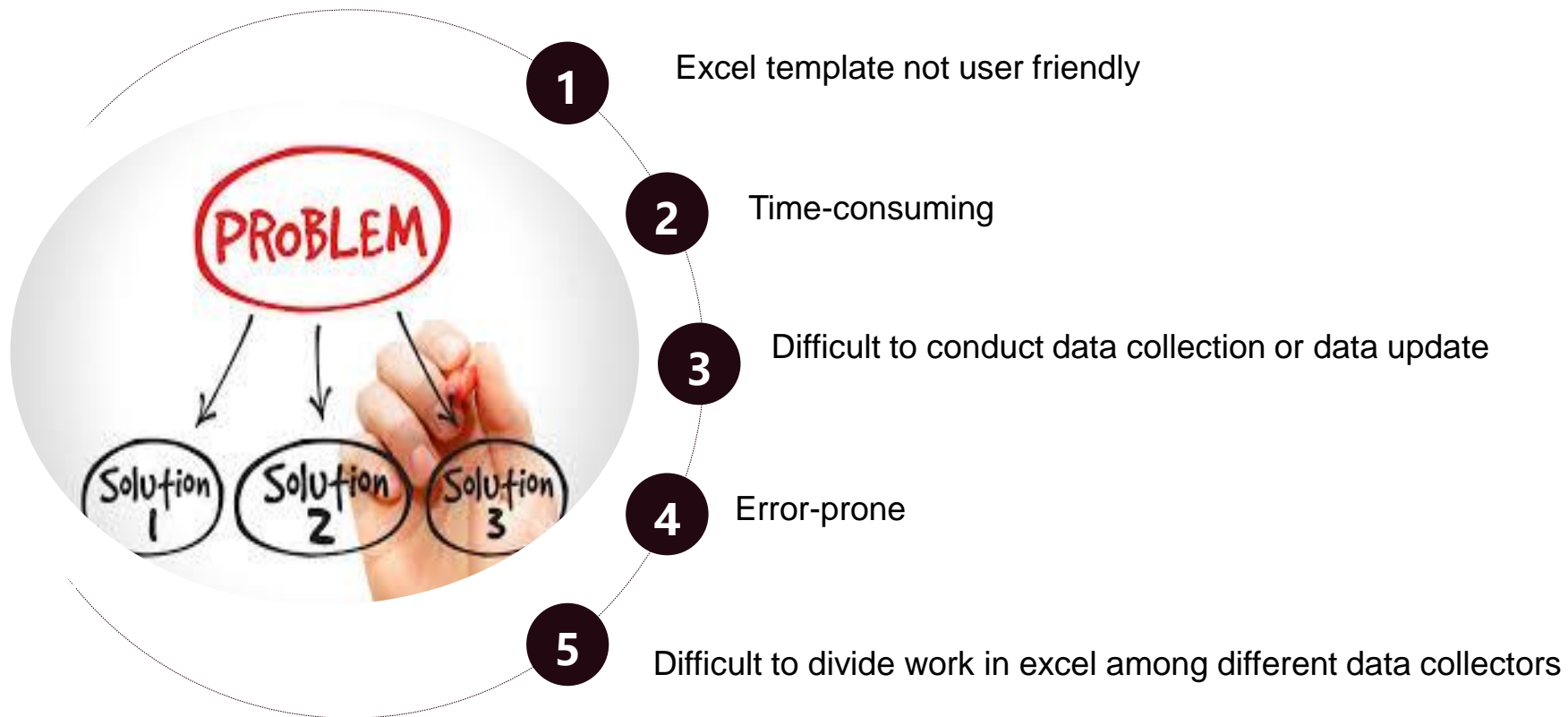

Introduction to TRAINS Online Tool

Real-time & collaborative online application that comprises of:

- 1** NTM data entry
- 2** NTM data validation
- 3** NTM data dissemination

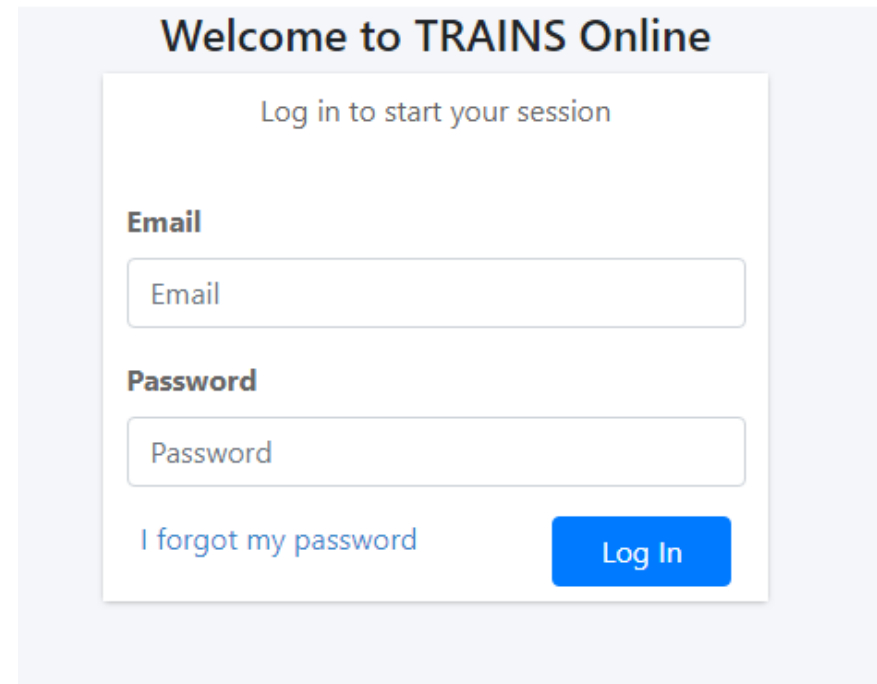

The screenshot shows the login interface for the TRAINS Online tool. It features a light blue background with a white login box. The title 'Welcome to TRAINS Online' is at the top. Below it, the text 'Log in to start your session' is centered. There are two input fields: 'Email' and 'Password'. A blue 'Log In' button is positioned to the right of the password field. A link 'I forgot my password' is located below the password field.



TRAINS Online Tool – Data Entry

How data was previously collected:

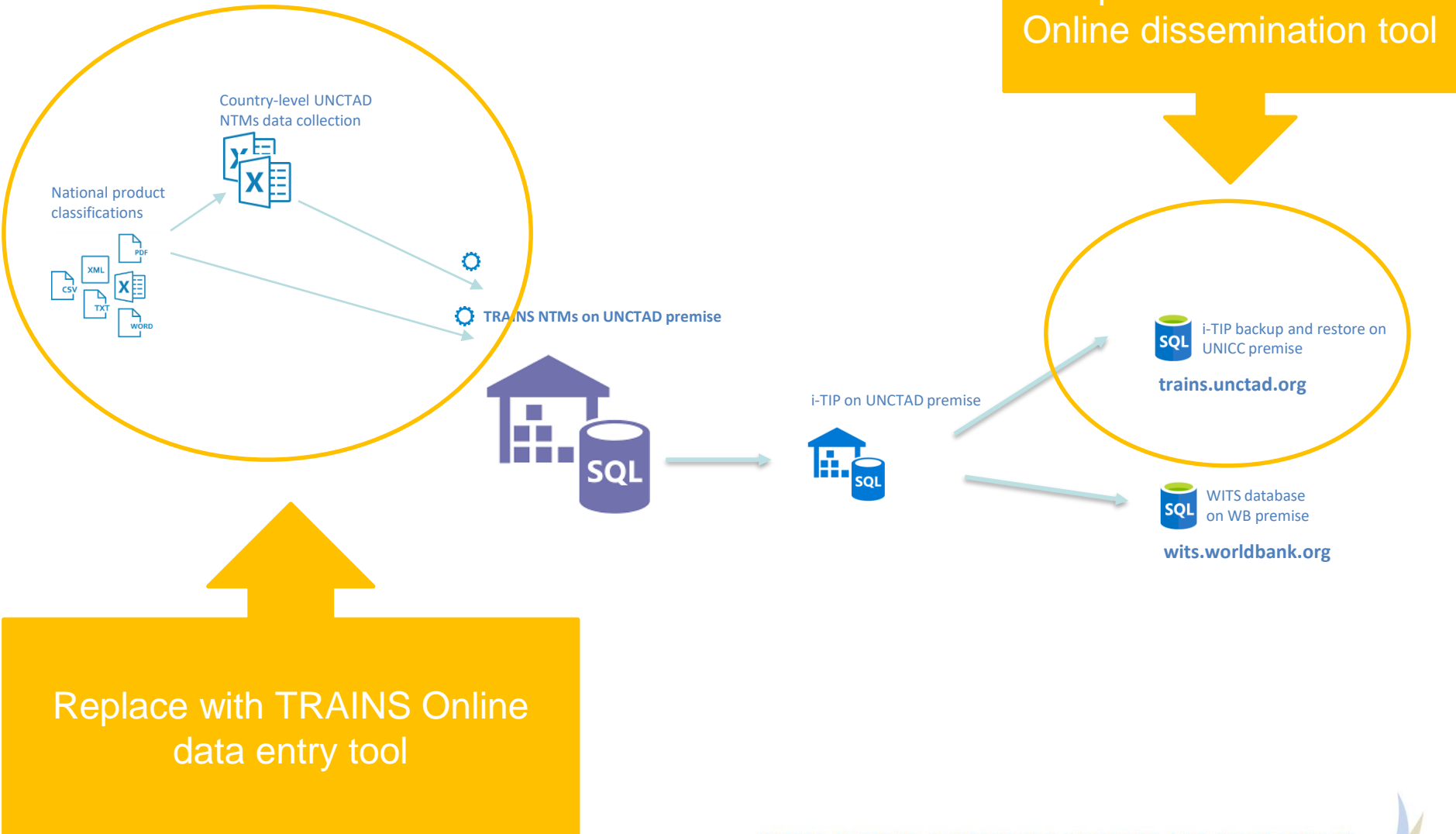

TRAINS Online Tool – Data Entry

Function include:

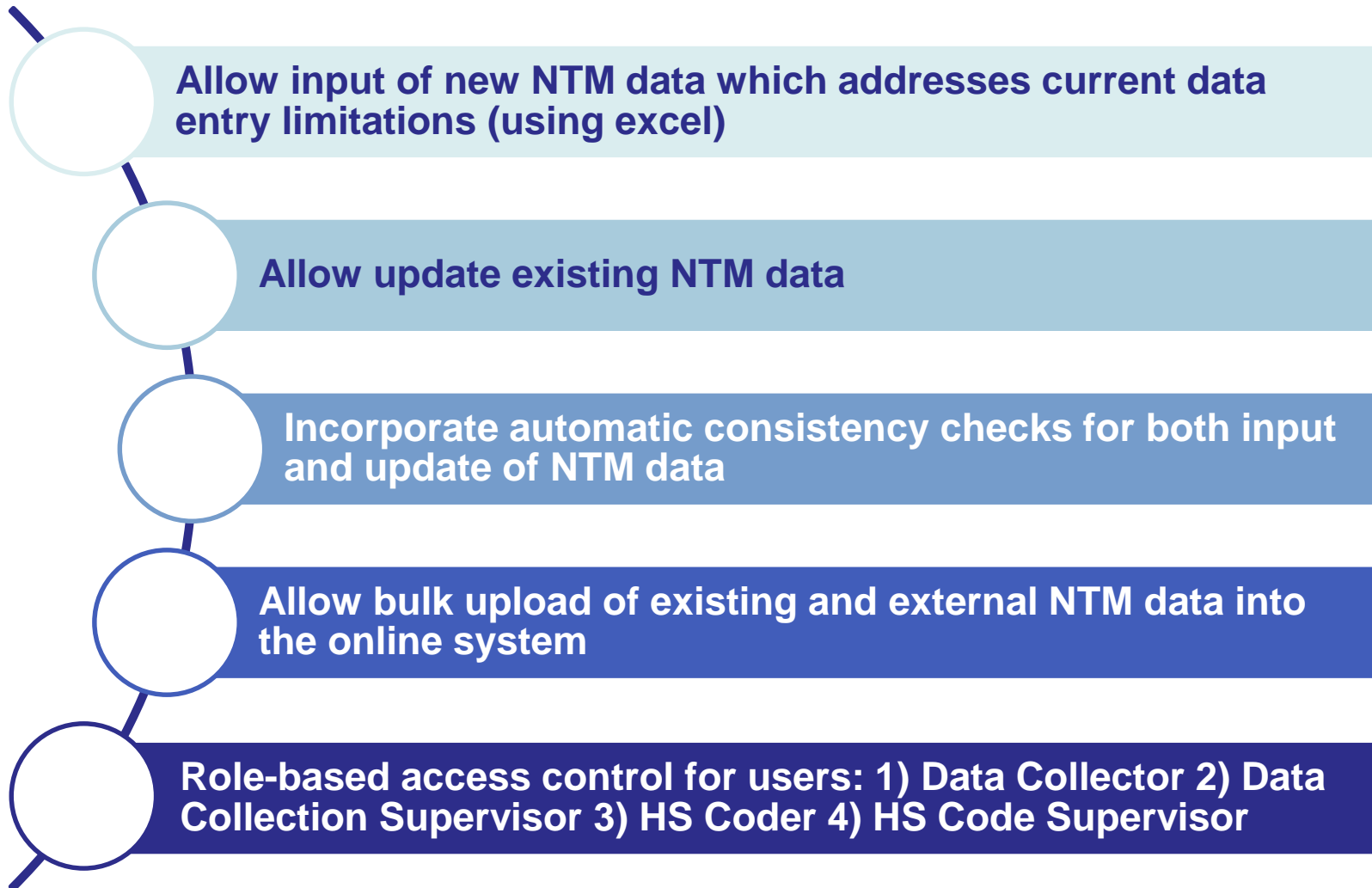

TRAINS Online Tool – Data Validation

Function include:

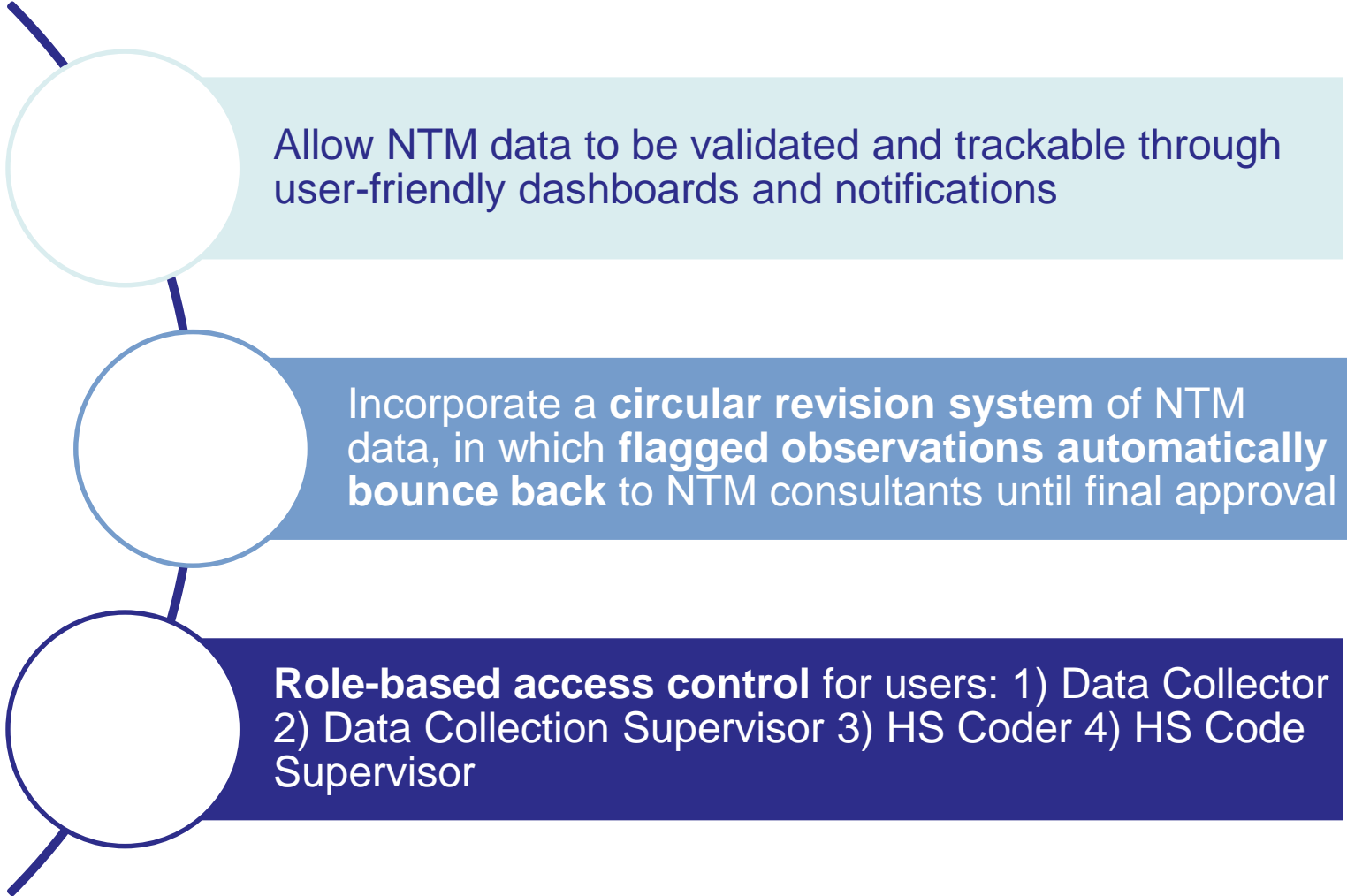

Allow NTM data to be validated and trackable through user-friendly dashboards and notifications

Incorporate a **circular revision system** of NTM data, in which **flagged observations automatically bounce back** to NTM consultants until final approval

Role-based access control for users: 1) Data Collector 2) Data Collection Supervisor 3) HS Coder 4) HS Code Supervisor



TRAINS Online Tool – Data Entry + Validation

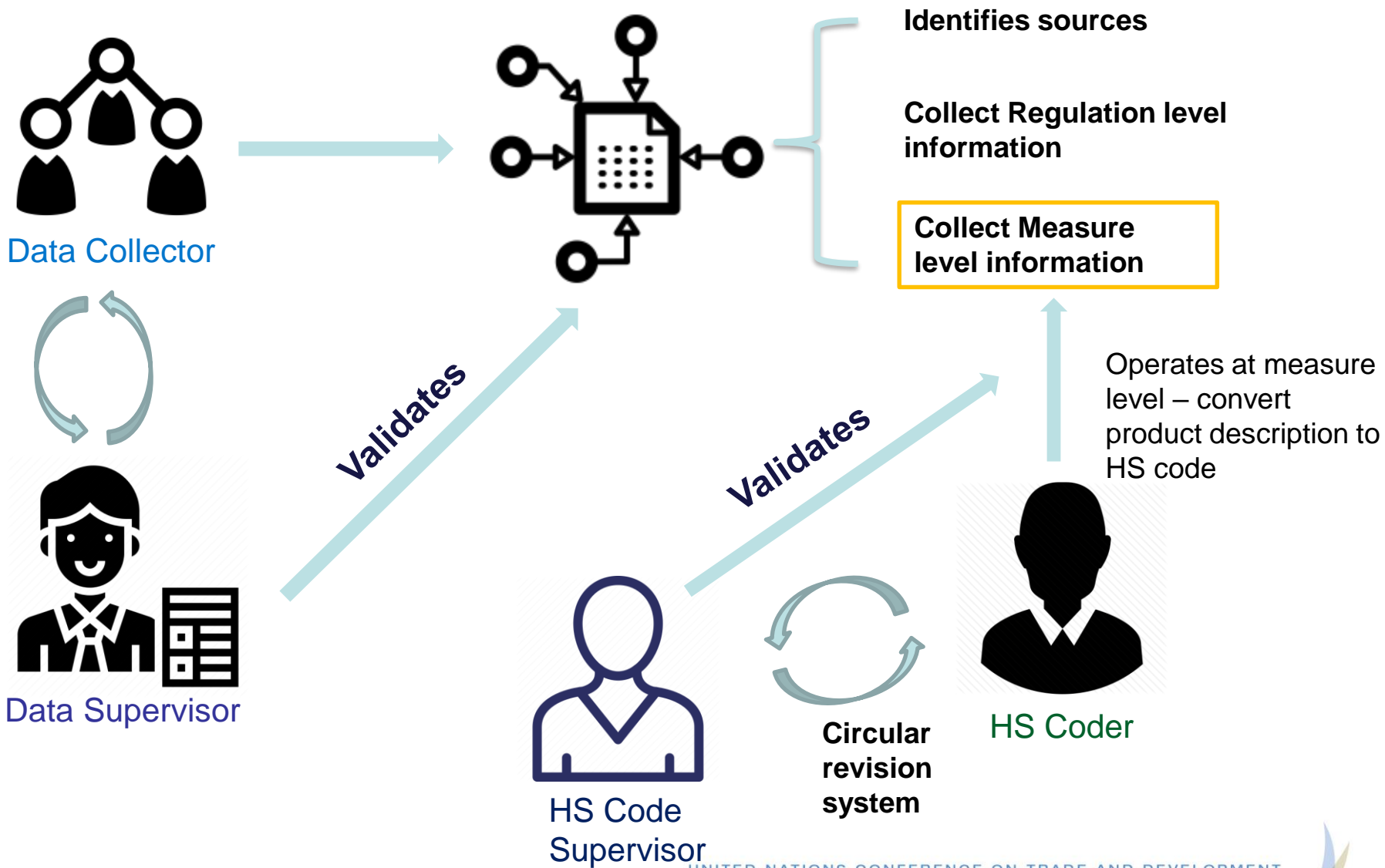

TRAINS Online Tool – Data Dissemination

Function include:

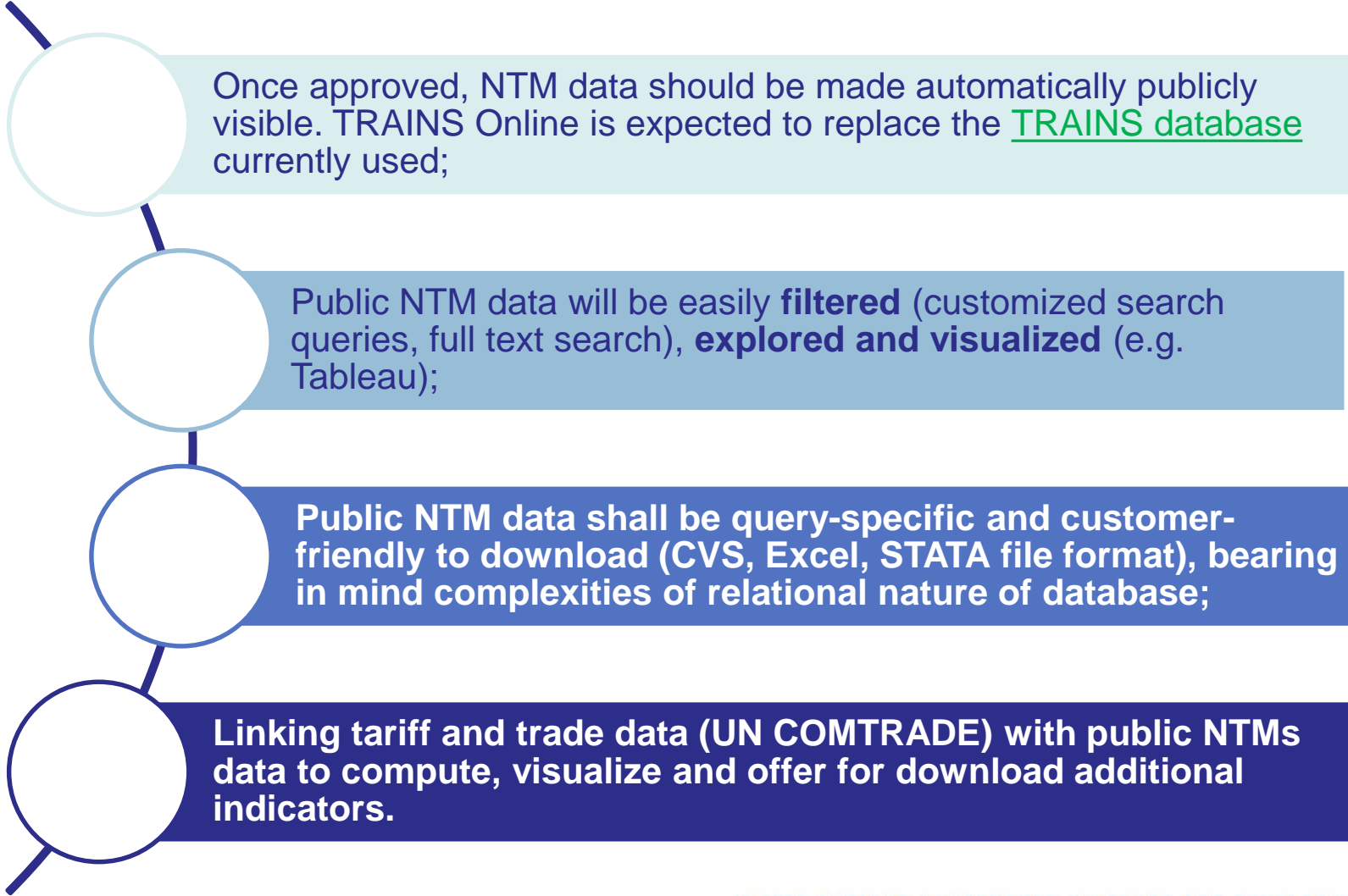

Once approved, NTM data should be made automatically publicly visible. TRAINS Online is expected to replace the [TRAINS database](#) currently used;

Public NTM data will be easily **filtered** (customized search queries, full text search), **explored and visualized** (e.g. Tableau);

Public NTM data shall be query-specific and customer-friendly to download (CSV, Excel, STATA file format), bearing in mind complexities of relational nature of database;

Linking tariff and trade data (UN COMTRADE) with public NTMs data to compute, visualize and offer for download additional indicators.



Current Data Dissemination Tools

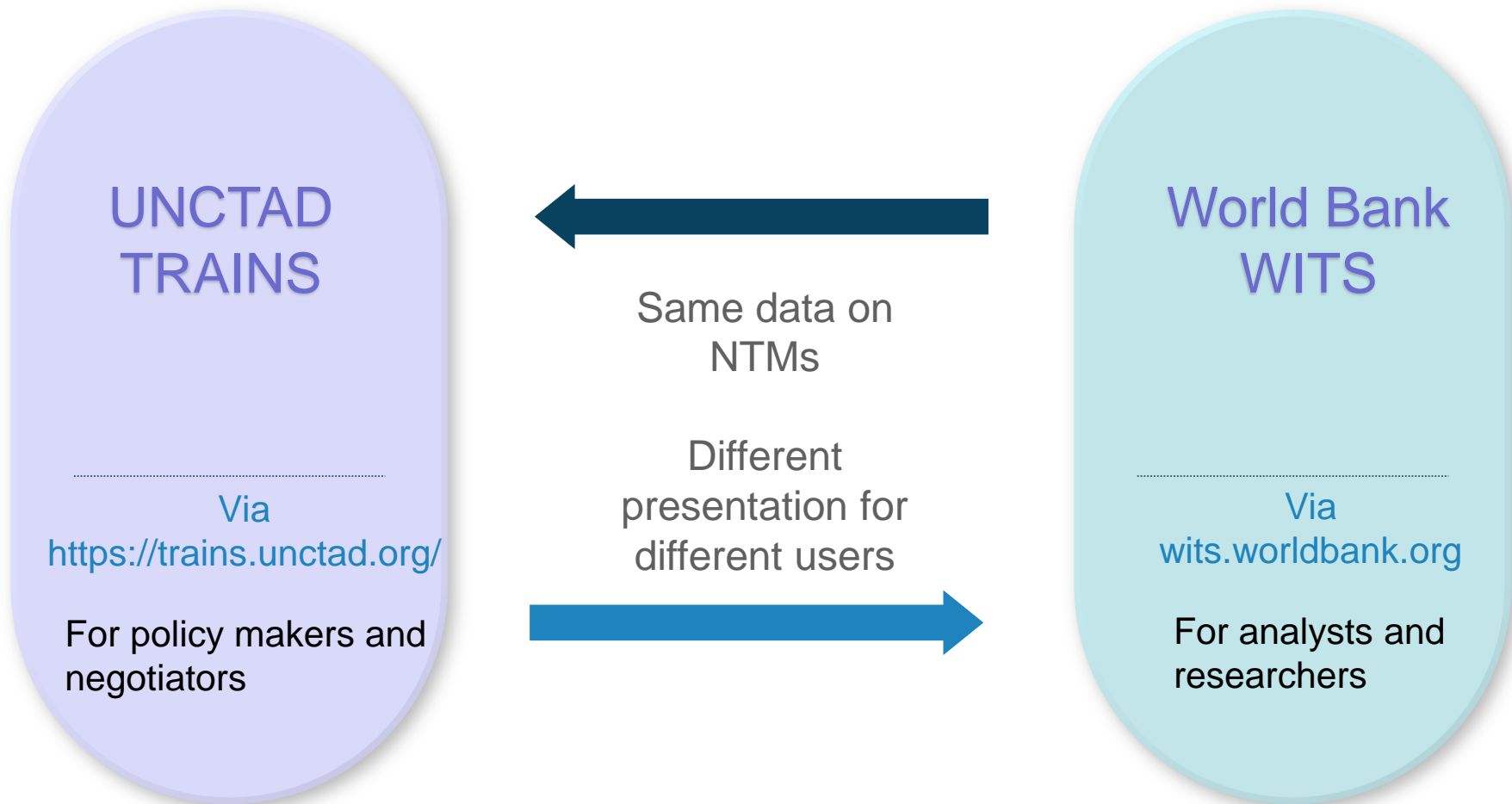

Map of Data Availability – A Global Initiative

Up until 2019, UNCTAD's NTM database covers data for 107 countries, containing more than 65000 measures.

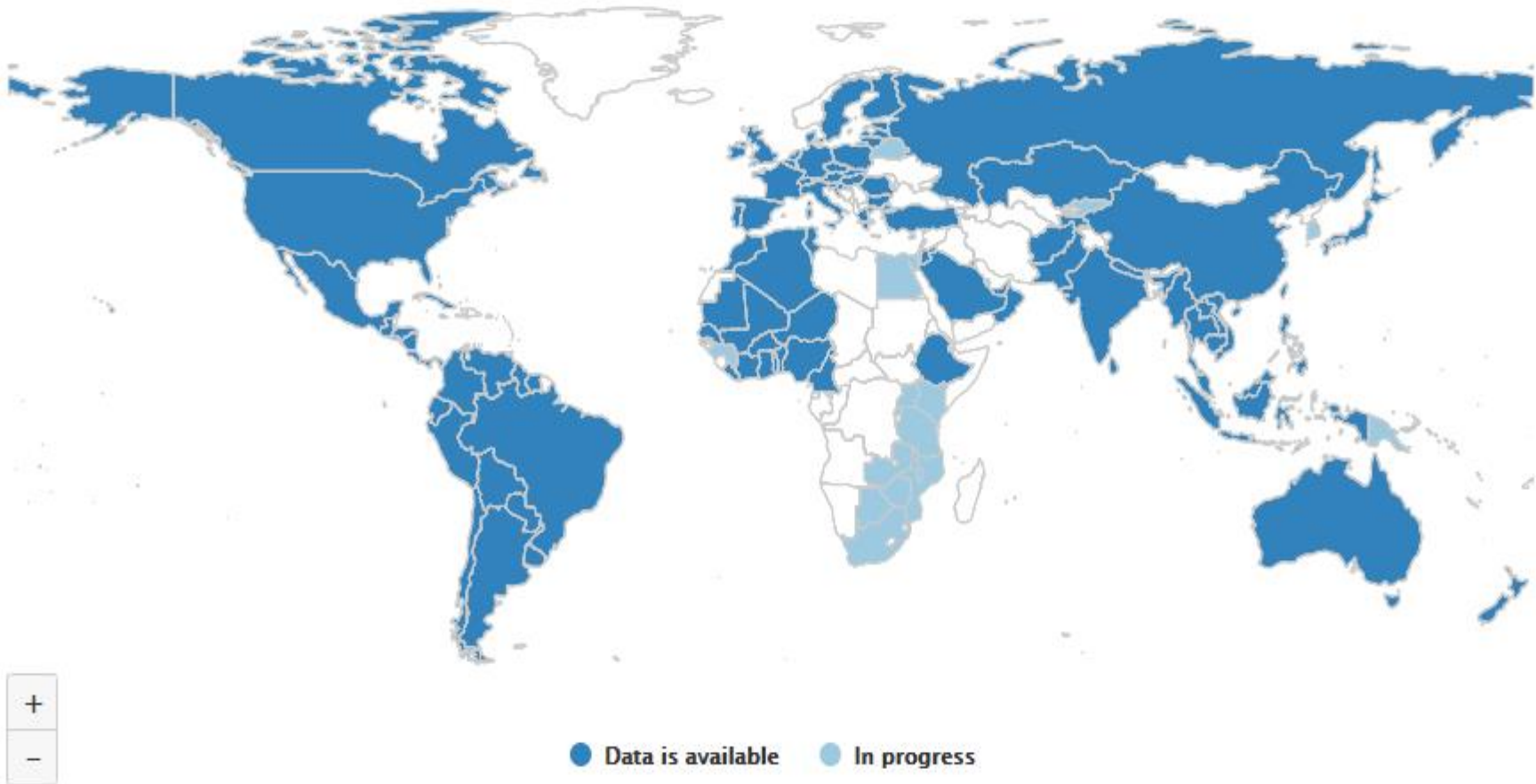

5/7/2018



Data Dissemination Channel – TRAINS

TRAINS (<https://trains.unctad.org/>)

The screenshot displays the TRAINS website interface. At the top, the title "TRAINS" is prominently displayed, followed by the subtitle "The global database on Non-Tariff Measures". Logos for partner organizations like UNCTAD, ALADI, ERIA, International Trade Centre, GRIPS, The World Bank, and WTO OMC are shown. A navigation bar includes tabs for "Home", "TABLES by PRODUCTS" (highlighted with a red box), "TABLES by MEASURE", "TABLES by COUNTRIES", "DETAILED QUERY", "ANALYSIS", and "About". Below the navigation, the main heading reads "TRAINS: Non-Tariff Measures (NTMs) based on official regulations". A "QUICK SEARCH" section features dropdown menus for "Country imposing" (set to "All countries"), "Partner affected" (set to "All partners"), and "Product affected" (set to "All products"), with a "Search" button. A "Choose one of the following options:" section lists three main categories: "TABLES by PRODUCTS", "TABLES by MEASURE", and "TABLES by COUNTRIES", each accompanied by a small thumbnail image and a brief description of the data view. A right-hand sidebar contains "ABOUT" and "WHAT'S NEW" sections with links to various documents and projects. At the bottom right, contact information "Contact us: tab@unctad.org" is provided.

Product

Measures

Country

Source: UNCTAD TRAINS

Search through “Tables by Products”

Search result

 Numbers cannot be compared

HS Code	Product description	TBT	SPS	INSP	CTPM	QC	PC	EXP	OTH
	Total	25659	29723	1809	338	6454	1452	7795	320
▶ Sec. I	Live animals and products	1866	6745	333	5	537	327	2143	78
▶ Sec. II	Vegetable products	2265	8722	837	3	567	490	2260	100
▶ Sec. III	Animal and vegetable fats, oils and waxes	1058	2294	137	3	264	199	896	56
▶ Sec. IV	Prepared foodstuff; beverages, spirits, vinegar; tobacco	3928	5819	291	4	552	407	1696	109
▶ Sec. IX	Wood, cork and articles; basketware	648	687	118	3	202	151	688	54
▶ Sec. V	Mineral products	2251	906	179	3	544	306	1018	92
▶ Sec. VI	Products of the chemical and allied industries	6812	2404	332	3	1796	507	2591	138
▶ Sec. VII	Resins, plastics and articles; rubber and articles	2222	446	135	3	449	200	668	69
▶ Sec. VIII	Hides, skins and articles; saddlery and travel goods	434	423	87	3	212	143	549	49
▶ Sec. X	Paper, paperboard and articles	596	260	85	3	274	137	368	60
▶ Sec. XI	Textiles and articles	1069	633	144	4	401	160	740	64
▶ Sec. XII	Footwear, headgear; feathers, artif. flowers, fans	459	255	56	3	150	117	414	49
▶ Sec. XIII	Articles of stone, plaster; ceramic prod.; glass	1222	186	94	3	281	140	459	57
▶ Sec. XIV	Pearls, precious stones and metals; coin	566	101	97	3	287	159	702	63
▶ Sec. XIX	Arms and ammunition	329	77	63	3	340	143	528	52
▶ Sec. XV	Base metals and articles	2196	285	124	9	413	173	744	66
▶ Sec. XVI	Machinery and electrical equipment	4668	118	151	3	682	249	616	82
▶ Sec. XVII	Vehicles, aircraft and vessels	1923	55	114	3	430	210	469	57

Search through “Tables by Products”

Search result

Your query covers 1866 measures

Show affected countries grouped (bilateral, All partners)

Export to excel

Measures:

Country imposing	Partner affected	Requirements	Phase	Measures	<input type="checkbox"/>
Algeria	All Members	Technical Barriers to Trade	In force	14	<input type="checkbox"/>
Antigua and Barbuda	All Members	Technical Barriers to Trade	In force	2	<input type="checkbox"/>
Australia	All Members	Technical Barriers to Trade	In force	44	<input type="checkbox"/>
Australia	Bilateral	Technical Barriers to Trade	In force	1	<input type="checkbox"/>
Bahamas	All Members	Technical Barriers to Trade	In force	5	<input type="checkbox"/>
Bahrain, Kingdom of	All Members	Technical Barriers to Trade	In force	6	<input type="checkbox"/>
Bahrain, Kingdom of	Bilateral	Technical Barriers to Trade	In force	1	<input type="checkbox"/>
Bangladesh	All Members	Technical Barriers to Trade	In force	9	<input type="checkbox"/>
Barbados	All Members	Technical Barriers to Trade	In force	13	<input type="checkbox"/>
Benin	All Members	Technical Barriers to Trade	In force	1	<input type="checkbox"/>

Search through “Tables by Products”

Search result

Your query covers 1866 measures and

Your selection resulted in 1866 measures



Export to excel



Return to summary

Measures:

Country imposing	Partner affected	Category	Measure description	Also domestic	Product description	HS	Source	National legal basis	In force
Guinea	All Members	TBT B81	Il faut faire une déclaration préalable avant d'importer les produits halieutiques	Undefined	Produits halieutiques	030191 030192 030193 ...	Division service Industrie Assurance Qualité des Produits de la Pêche et de l'Aquaculture/ Ministère de la Pêche et de l'Aquaculture - Textes...	Arrêté A/2009/4009/MIPA/SGG du 30 décembre 2009 portant réglementation de l'importation des produits de la pêche et de l'aquaculture	30/12/2009 Withdrawn
Guinea	All Members	TBT B81	Obligation de faire une déclaration descriptive d'importation pour toute opération dont la valeur est égale ou supérieure à l'équivalent en franc guinéen de 2000...	Undefined	Tout produit dont l'opération d'importation a une valeur égale ou supérieur à l'équivalent en franc guinéen de 2000 dollars US	01 02 03 ...	Direction nationale du commerce extérieur - Journal officiel de la République No 23 et 24 du 10 et 25/12/2009	Arrêté A2009/3830/MCIPME/SGG du 16 décembre 2009 portant création du guichet unique de déclaration descriptive d'importation (DDI) et de déclaration...	16/12/2009
Guinea	All Members	TBT B84	Obligation d'effectuer une inspection par le système de scanographie de tous les conteneurs et colis fermés à l'importation	Undefined	Les conteneurs et colis fermés (de tous les produits)	01 02 03 ...	Direction générale de la Douane - Arrêté conjoint n 4454 portant exploitation d'équipements de scanographie des conteneurs et des colis fermés au...	Arrêté conjoint n 4454 portant exploitation d'équipements de scanographie des conteneurs et des colis fermés au port de Conakry	23/08/2006
Guinea	All Members	TBT B83	Obligation pour les importateurs de présenter un certificat d'origine pour les cuirs et peaux séchés et salés	Undefined	Les cuirs et peaux séchés et salés, aliments pour animaux, produits halieutiques et autres sous produits	02 03 04	Sécrétariat général du gouvernement - Journal officiel de la République No 02 du 25/01/1990	Décret D/004/PRG/SGG/90 du 15 janvier 1990 portant mesures permanentes de police sanitaire des	15/01/1990



Export Search Outcome into Excel

1
Type of measure

4
Whether the measure is also a domestic measure

UNCTAD, TRAINS NTMs database through Integrated Trade Intelligence Portal (I-TIP), Extract made on 18/06/2017

Your query covers 17 measures

Measures: Sanitary and Phytosanitary [SPS] [A]
 Country(ies) imposing: New Zealand
 Partner(s) affected: Any [Include the category "All partners"]
 Date(s): 18/06/2017 [in force]
 Product(s): HS codes: 50 OR 51 OR 52 OR 53 OR 54 OR 55 OR 56 OR 57 OR 58 OR 59 OR 60 OR 61 OR 62 OR 63

2
Country imposing the NTMs

Your selection resulted in 17 measures

Country imposing	Partner affected	Categ	NTM Code	In force	Withdrawn	Measure description	Also domes	Product description	HS
New Zealand	All Members	SPS	A82	2015-06-30		Grow-out test' in either the exporting country of New Zealand	No	Coco peat (coir pith and coir peat) products	5305, 530810, 570220
New Zealand	All Members	SPS	A83	2015-06-30		1.7 Phytosanitary certificate (1) All fertiliser and growing media products	No	1.1(1) This import health standard (IHS) applies to the following fertilisers and growing media	2703, 3103, 5305, 530810, 5
New Zealand	All Members	SPS	A852	2015-06-30		1.8 Manufacturer's certificate [are required] ...manufacturer's certificates must ... include the	No	1.1(1) This import health standard (IHS) applies to the following fertilisers and growing media	2703, 3103, 5305, 530810, 5
New Zealand	All Members	SPS	A59	2015-06-30		A range of treatment options are provided	No	Coco peat (coir pith and coir peat) products	5305, 530810, 570220

3
Measure along with detailed measure description









5
HS to the most detailed level possible

Search through “Tables by Measure”

TRAINS

The global database on Non-Tariff Measures

Through 
Developed by WTO
Adapted for TRAINS data by
UNCTAD

Home | TABLES by PRODUCTS | **TABLES by MEASURE** | TABLES by COUNTRIES | DETAILED QUERY | ANALYSIS | About

TRAINS: Non-Tariff Measures (NTMs) based on official regulations

QUICK SEARCH

Country imposing:

Partner affected:

Product affected:

Choose one of the following options:

TABLES by PRODUCTS

- Look at the incidence of NTMs by HS sections and chapters, and by country imposing the measure.
- See individual measures by simply clicking on any number in the tables!
- This option does not allow a selection of products.

TABLES by MEASURE

- Look at the incidence of NTMs by country imposing the measure.
- This option does not allow a selection of products.

TABLES by COUNTRIES

- Look at the incidence of NTMs by country and geographical regions.
- See individual measures by simply clicking on any number in the tables!

ABOUT

- [How To](#)
- [Available Countries](#)
- [Map of the Application](#)
- [Classification used in the application](#)
- [Partners and Donors](#)
- [Disclaimer](#)

WHAT'S NEW

- [TPP Project](#)
- [APEC Project](#)
- [ASEAN Project](#)

Contact us: tab@unctad.org

Source: UNCTAD TRAINS

UNITED NATIONS CONFERENCE ON TRADE AND DEVELOPMENT

UNCTAD

Search through “Tables by Measure”

Search result

i Numbers cannot be compared

NTM Code	Description	AFRICA	ASIA	EUROPE	LAC	MIDDLE EAST	NORTHERN AMERICA	OCEANIA
A	Sanitary and phytosanitary measures	<u>1709</u>	<u>8846</u>	<u>443</u>	<u>12157</u>	<u>1241</u>	<u>3470</u>	<u>2225</u>
B	Technical barriers to trade	<u>1798</u>	<u>11676</u>	<u>818</u>	<u>4697</u>	<u>778</u>	<u>3660</u>	<u>2331</u>
C	Pre-shipment inspection and other formalities	<u>121</u>	<u>561</u>	<u>224</u>	<u>215</u>	<u>155</u>	<u>501</u>	<u>34</u>
D	Contingent trade protective measures	<u>3</u>	<u>7</u>	<u>2</u>	<u>321</u>			
E	Non-automatic import licensing, quotas, prohibitions, quantity-control measures and other restrictions other than SPS or TBT measures	<u>471</u>	<u>1768</u>	<u>218</u>	<u>3062</u>	<u>445</u>	<u>334</u>	<u>166</u>
F	Price control measures including additional taxes and charges	<u>182</u>	<u>735</u>	<u>35</u>	<u>230</u>	<u>125</u>	<u>70</u>	<u>85</u>
G,H,I,J,K,L,M,N,O	Others	<u>54</u>	<u>165</u>	<u>8</u>	<u>53</u>	<u>33</u>	<u>3</u>	<u>5</u>
P	Export related measures	<u>925</u>	<u>4049</u>	<u>179</u>	<u>1387</u>	<u>427</u>	<u>330</u>	<u>553</u>

Search through “Tables by Measure”

Search result

Your query covers 818 measures

Show affected countries grouped (bilateral, All partners)

 Export to excel  Show details

Measures:

Country imposing	Partner affected	Requirements	Phase	Measures	<input type="checkbox"/>
European Union	All Members	Technical Barriers to Trade	In force	263	<input type="checkbox"/>
European Union	Bilateral	Technical Barriers to Trade	In force	29	<input type="checkbox"/>
Russian Federation	All Members	Technical Barriers to Trade	In force	307	<input type="checkbox"/>
Russian Federation	Bilateral	Technical Barriers to Trade	In force	6	<input type="checkbox"/>
Switzerland	All Members	Technical Barriers to Trade	In force	184	<input type="checkbox"/>
Switzerland	Bilateral	Technical Barriers to Trade	In force	4	<input type="checkbox"/>
Turkey	Bilateral	Technical Barriers to Trade	In force	26	<input type="checkbox"/>

Search through “Tables by Measure”

Search result

Your query covers 818 measures and
Your selection resulted in 818 measures



Export to excel



Return to summary

Measures:

Country imposing	Partner affected	Category	Measure description	Also domestic	Product description	HS	Source	National legal basis	In force Withdrawn
European Union	All Members	TBT B31	Import documentation and labelling: import operations involving scheduled substances of all categories, with the exception of those substances listed in catego...	Undefined	This measure is exclusively related certain chemical substances frequently used in the illicit manufacture of narcotic drugs and psychotropic substances (precur...	280610 2807 284161 ...			01/10/2009
European Union	All Members	TBT B83	Imports of fishery products must be accompanied by a catch certificate in order to demonstrate that the products concerned do not originate from IUU...	Undefined	Fishery products	030191 030192 030194 ...			01/10/2010
European Union	All Members	TBT B41	According to these procedures, the manufacture must provide technical documentation for the conformity assessment and keep it at the disposal of the relevant na...	Undefined	Product scope: Commission Regulation (EC) No 640/2009 applies to electric motors, including where integrated in other products, defined as electric single speed...	850120 850131 850132 ...			01/10/2011
European Union	All Members	TBT B83	CE marking (consider as Certification Requirement): Before an electric	Undefined	Product scope: Commission Regulation (EC) No 640/2009 applies	850120 850131			01/10/2011

« 1 2 3 4 5 6 7 8 9 10 ... »

Page size: 10









818 items in 82 pages

Search through “Tables by Countries”

TRAINS

The global database on Non-Tariff Measures

Through 
Developed by WTO
Adapted for TRAINS data by
UNCTAD



HomeTABLES by PRODUCTSTABLES by MEASURETABLES by COUNTRIESDETAILED QUERYANALYSISAbout

TRAINS: Non-Tariff Measures (NTMs) based on official regulations

QUICK SEARCH

Country imposing:

Partner affected:

Product affected:

Choose one of the following options:

TABLES by PRODUCTS

- Look at the incidence of NTMs by HS sections and chapters, and by country imposing the measure.
- See individual measures by simply clicking on any number in the tables!
- This option does not allow a selection of products.

TABLES by MEASURE

- Look at the incidence of NTMs by country imposing the measure.
- This option does not allow a selection of products.

TABLES by COUNTRIES

- Look at the incidence of NTMs by country and geographical regions.
- See individual measures by simply clicking on any number in the tables!

ABOUT

- [How To](#)
- [Available Countries](#)
- [Map of the Application](#)
- [Classification used in the application](#)
- [Partners and Donors](#)
- [Disclaimer](#)

WHAT'S NEW

- [TPP Project](#)
- [APEC Project](#)
- [ASEAN Project](#)

Contact us: tab@unctad.org



Search through “Tables by Countries”

Search result

i Numbers cannot be compared

		CTPM	EXP	INSP	OTH	PC	QC	SPS	TBT
Africa	Algeria		13	4	1	1	34	114	122
	Benin		20	12	3	5	20	27	34
	Botswana		58	1	2	1	18	61	85
	Burkina Faso		14	3	2	1	8	39	5
	Cameroon		90			10	29	42	51
	Cabo Verde		3	1	3	8	4	31	28
	Côte d'Ivoire	3	14	1		4	8	69	7
	Ethiopia		139	1	7	3	32	103	213
	Ghana		35	7		7	26	20	25
	Guinea		75	7	3	22	7	35	19
	Liberia, Republic of		45	2	2	10	21	23	21
	Mali		68	3	4	8	17	34	27
	Mauritania		42	4	7	4	23	98	55
	Mauritius		40	12	2	7	40	318	358
	Morocco		42	4	1	6	35	208	91
	Niger		12	3		4	9	14	21
	Nigeria		3	1		1	15	51	26
	Senegal		23	28		2	10	70	13
	The Gambia		4		2	5	16	77	50
	Togo		23		2	6	32	10	23
Tunisia		87	21	12	46	36	96	117	
Zimbabwe		75	6	1	21	31	169	407	
Africa Total		3	925	121	54	182	471	1709	1798

Search through “Tables by Countries”

Search result

Your query covers 13 measures

Show affected countries grouped (bilateral, All partners)

Export to excel  Show details



Measures:

Country imposing	Partner affected	Requirements	Phase	Measures	<input checked="" type="checkbox"/>
Algeria	All Members	Export-related measures	In force	13	<input checked="" type="checkbox"/>

Search through “Tables by Countries”

Search result

No records found.
13 measures

 Export to excel  Return to summary

Measures:

Country imposing	Partner affected	Category	Measure description	Also domestic	Product description	HS	Source	National legal basis	In force Withdrawn
			the rules of Energy Efficiency and running on el...			...	conditioners subject to the rules of Energy Efficiency...	Energy Efficiency and running on...	
Algeria	All Members	EXP P33	Only registered exporters can export veterinary medicines from Algeria	Undefined		2936 2937 2938 ...	Unspecified source - Executive Decree No. 09-102 of 13 Rabie El Aouel 1430 corresponding to 10 March 2009 laying down the measures applicable at...	Executive Decree No. 09-102 of 13 Rabie El Aouel 1430 corresponding to 10 March 2009 laying down the measures applicable at import and export of...	01/03/2009 01/01/9999
Algeria	All Members	EXP P163	Certificate of conformity is required for veteraniiry medicines to be exported	Undefined		2936 2937 2938 ...	Unspecified source - Executive Decree No. 09-102 of 13 Rabie El Aouel 1430 corresponding to 10 March 2009 laying down the measures applicable at...	Executive Decree No. 09-102 of 13 Rabie El Aouel 1430 corresponding to 10 March 2009 laying down the measures applicable at import and export of...	01/03/2009 01/01/9999
Algeria	All Members	EXP P162	Measures applicable on import of pesticides (phytosaniatry products) for agricultural use.	Undefined		3808	Unspecified source - Executive Decree No. 10-69 of 15 Safar 1431 corresponding to 31 January 2010 laying down the measures applicable in the import...	Executive Decree No. 10-69 of 15 Safar 1431 corresponding to 31 January 2010 laying down the measures applicable in the import and export of...	01/01/2010 01/01/9999

Page size: 10

13 items in 2 pages

Search through “Detailed Query”



Home

TABLES by PRODUCTS

TABLES by MEASURE

TABLES by COUNTRIES

DETAILED QUERY

ANALYSIS

About

Available search criteria

Product(s) affected by the measure

Full text search on the measure product description (comma separated, max. 5):

Apply Filter

OR AND

HS based search:

Version: 1.0

Search

Find

Clear

Section:

- All
- 50 SILK
- 51 WOOL, FINE OR COARSE ANIMAL HAIR; HORSEHAIR YARN AND WOVEN FABRIC
- 52 COTTON
- 53 OTHER VEGETABLE TEXTILE FIBRES; PAPER YARN AND WOVEN FABRICS OF PAPER YARN
- 54 MAN-MADE FILAMENTS; STRIP AND THE LIKE OF MAN-MADE TEXTILE MATERIALS
- 55 MAN-MADE STAPLE FIBRES
- 56 WADDING, FELT AND NONWOVENS; SPECIAL YARNS; TWINE, CORDAGE, ROPES AND CABLES AND ARTICLES THEREOF

No selection = Any

Apply Filter

Country(ies) imposing the measure

Partner(s) affected by the measure

Measures

Search through “Detailed Query”

TRAINS

The global database on Non-Tariff Measures

Through



Developed by WTO
Adapted for TRAINS data by
UNCTAD



Home

TABLES by PRODUCTS

TABLES by MEASURE

TABLES by COUNTRIES

DETAILED QUERY

ANALYSIS

About

Available search criteria

- Product(s) affected by the measure
- Country(ies) imposing the measure
- Partner(s) affected by the measure
- Measures
- Date(s)

UNITED NATIONS CONFERENCE ON TRADE AND DEVELOPMENT

UNCTAD

Search through “Detailed Query”

Available search criteria

Product(s) affected by the measure

Full text search on the measure product description (comma separated, max. 5):

OR AND

HS based search:

Version: 1.0

Section:

- All
- 01 LIVE ANIMALS
- 02 MEAT AND EDIBLE MEAT OFFAL
- 03 FISH AND CRUSTACEANS, MOLLUSCS AND OTHER AQUATIC INVERTEBRATES
- 04 DAIRY PRODUCE; BIRDS' EGGS; NATURAL HONEY; EDIBLE PRODUCTS OF ANIMAL ORIGIN, NOT ELSEWHERE SPECIFIED OR INCLUDED
- 05 PRODUCTS OF ANIMAL ORIGIN, NOT ELSEWHERE SPECIFIED OR INCLUDED
- 06 LIVE TREES AND OTHER PLANTS; BULBS, ROOTS AND THE LIKE; CUT FLOWERS AND ORNAMENTAL FOLIAGE
- 07 EDIBLE VEGETABLES AND CERTAIN ROOTS AND TUBERS

If you don't select any, no filter is applied



Search through “Detailed Query”

Available search criteria

Product(s) affected by the measure

Country(ies) imposing the measure

Cuba	Argentina
Dominica	Bangladesh
Ecuador	European Union
El Salvador	Ghana
Ethiopia	
Grenada	
Guatemala	

If you don't select any, no filter is applied

Partner(s) affected by the measure

Measures

Date(s)



Search through “Detailed Query”

Available search criteria

Product(s) affected by the measure

Country(ies) imposing the measure

Partner(s) affected by the measure

Measures

Date(s)

If you don't select any, no filter is applied

Afghanistan

Algeria

Antigua and Barbuda

Australia

Bahamas

Bahrain, Kingdom of

Barbados

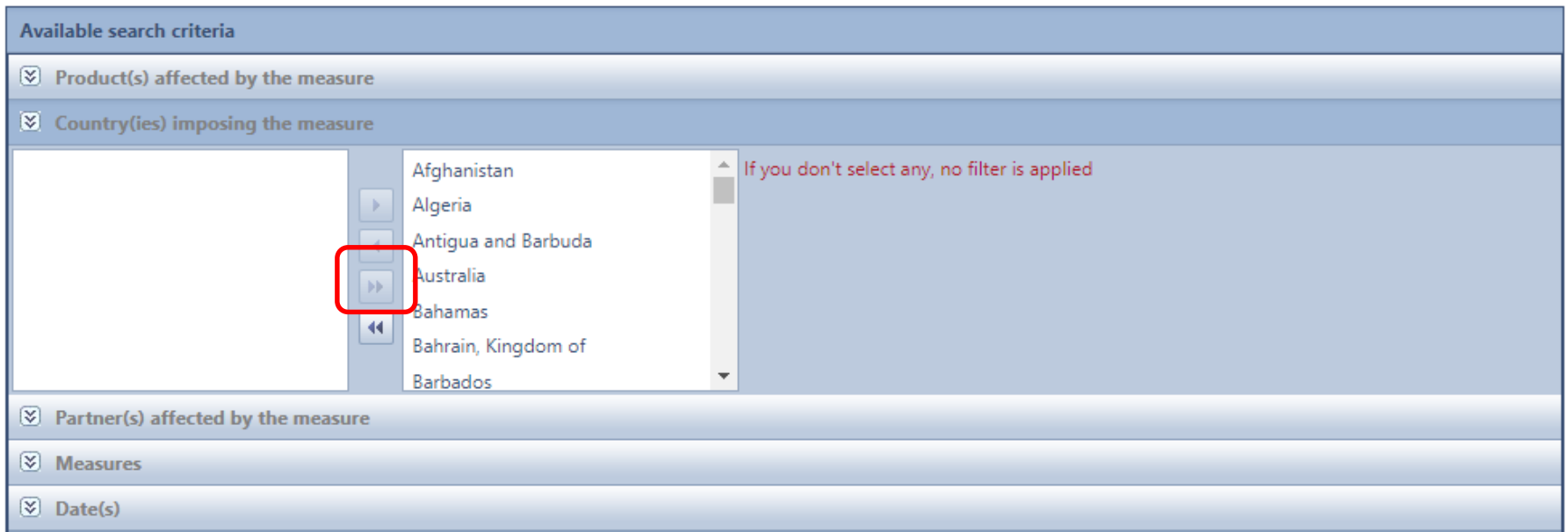

Search through “Detailed Query”

Available search criteria

- Product(s) affected by the measure
- Country(ies) imposing the measure
- Partner(s) affected by the measure
- Measures
 - A - Sanitary and phytosanitary measures
 - B - Technical barriers to trade
 - C - Pre-shipment inspection and other formalities
 - D - Contingent trade protective measures
 - E - Non-automatic import licensing, quotas, prohibitions, quantity-control measures and other restrictions other than SPS or TBT measures
 - F - Price control measures including additional taxes and charges
- Date(s)

Apply Filter





Search through “Detailed Query”

Available search criteria

- Product(s) affected by the measure
- Country(ies) imposing the measure
- Partner(s) affected by the measure
- Measures
- Date(s)

Measures at a selected date Measures taken during period of time

05/08/2019  From  To 

initiated initiated

entered into force entered into force

withdrawn



Search through “Detailed Query”

Available search criteria	
<input checked="" type="checkbox"/>	Product(s) affected by the measure
<input checked="" type="checkbox"/>	Country(ies) imposing the measure
<input checked="" type="checkbox"/>	Partner(s) affected by the measure
<input checked="" type="checkbox"/>	Measures
<input checked="" type="checkbox"/>	Date(s)

Selected search criteria		
Measures:	Sanitary and Phytosanitary [SPS] [A], Technical Barriers to Trade [TBT] [B], Pre-shipment inspection [INSP] [C], Contingent trade protective measures [CTPM] [D], Quantity control measures [QC] [E], Price control measures [PC] [F], Other measures [OTH] [G,H,I,J,K,L,M,N,O], Export-related measures [EXP] [P]	<input type="button" value="Reset to defaults"/>
Country(ies) imposing:	Any	
Partner(s) affected:	Any [Include the category "All partners"]	
Date(s):	05/08/2019 [in force]	
Product(s):	Any	<input type="button" value="Search"/>

Search result



How to Browse TRAINS

Search for: NTMs that the EU imposes on Vietnamese salted cashew nuts

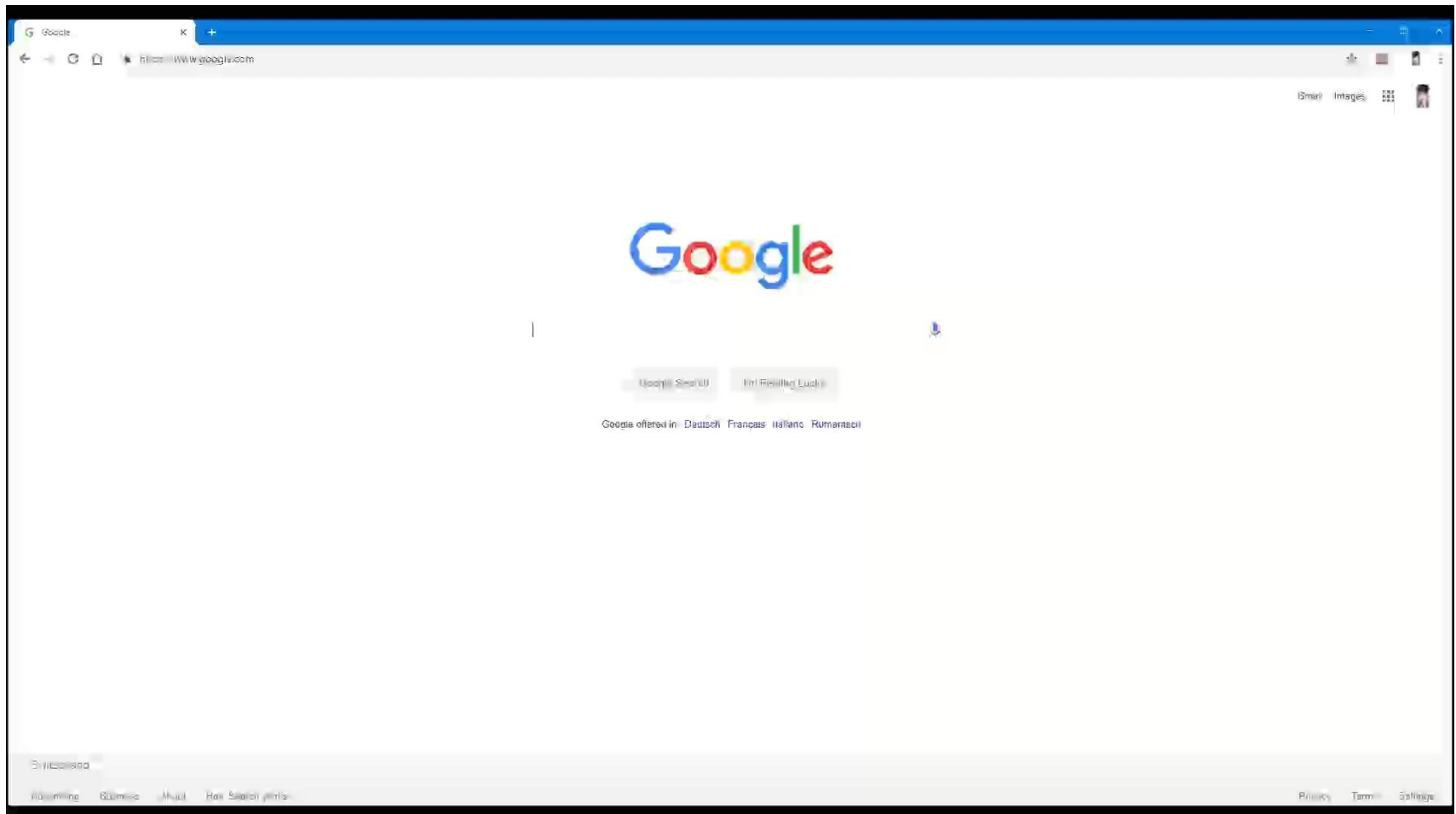

For Researchers: STATA file

TRAINS

The global database on Non-Tariff Measures

Through



Developed by WTO
Adapted for TRAINS data by
UNCTAD



Home

TABLES by PRODUCTS

TABLES by MEASURE

TABLES by COUNTRIES

DETAILED QUERY

ANALYSIS

About

NTMs TRAINS researcher file

You can download here the NTMs TRAINS researcher file for use in Stata (version 12) containing all non-tariff measures aggregated at the HS 6-digit level by researchers and data analysts. You will also find a file with the names and country codes to expand the data to a fully bilateral structure. The data can easily be used for descriptive statistics as well as for quantitative analysis by merging the file for instance with trade and other datasets.

The data collection follows a standardized and globally coherent approach described in the [UNCTAD Guidelines to Collect Data on Non-Tariff Measures](#). However, the different regulatory practices in each country complicate cross-country comparisons. The user guide provides more information. Furthermore, the highest quality control standards are applied but collecting and classifying NTMs is a very complex exercise so that errors can occur.

 [Get the data](#)

Please refer to the database as "UNCTAD (2017), TRAINS NTMs: The Global Database on Non-Tariff Measures".

UNITED NATIONS CONFERENCE ON TRADE AND DEVELOPMENT

UNCTAD

Practice Exercises – TRAINS Database

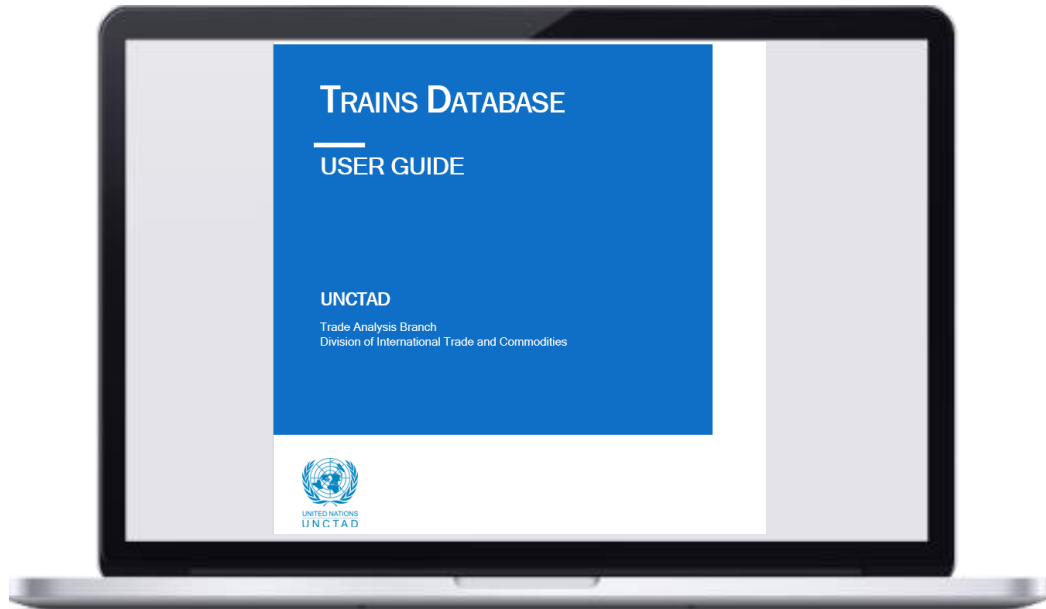

Please open the User Manual
go to page 8, 12, and 16.



Thank you!

UNCTAD
PROSPERITY FOR ALL

www.unctad.org



UNITED NATIONS
UNCTAD

TRAINS Online Tool – Data Entry: Dashboard

Dashboard

Datasets

Regulations

Measures

50 ▾ 8 columns selected ▾ Select a bulk action ▾			<input type="button" value="Selection Only"/> <input type="button" value="All Data"/>					
<input type="checkbox"/>	Actions	Id	Feedback	Dataset	Title	State	User	Timestamp
<input type="checkbox"/>	→ Ready for publication	148		Dataset in Albania sec...	Dataset in Albania sec...	Data collection	Daniel01 Blendea	2019-07-23 14:...
<input type="checkbox"/>	→ Ready for publication	149		Data in Albania A and B	Data in Albania A and B	Data collection	Fabien Dumesnil	2019-07-10 15:...
<input type="checkbox"/>		6		Data collection in Côte ...	Data collection in Côte ...	Ready for publication	Fabien Dumesnil	2019-07-05 07:...
<input type="checkbox"/>	→ Ready for publication	141		Space	Space	Data collection	Ovidiu Filoș	2019-07-01 09:...
<input type="checkbox"/>		142		data collection for coffee	data collection for coffee	Ready for publication	Ovidiu Filoș	2019-06-28 14:...
<input type="checkbox"/>	→ Ready for publication	140		test2	test2	Data collection	fcc573db-6fa0-45f9-9a...	2019-03-15 16:...
<input type="checkbox"/>		50		Data collection in Sout...	Data collection in Sout...	Ready for publication	WIN10-DEVDaniel	2018-12-13 16:...
<input type="checkbox"/>		87		Data collection in Belar...	Data collection in Belar...	Ready for publication	WIN10-DEVDaniel	2018-12-13 16:...
<input type="checkbox"/>	→ Ready for publication	88		Data collection in India	Data collection in India	Data collection	WIN10-DEVDaniel	2018-12-05 13:...
<input type="checkbox"/>	→ Ready for publication	143		China Dataset Test	China Dataset Test	Data collection		



TRAINS Online Tool – Data Entry: List of Regulations

Regulations

50 ▾ 21 columns selected ▾ Select a bulk action ▾

📄 Selection Only
📄 All Data

<input type="checkbox"/>		Id ▾	State ▾	Dataset Name ▾	Source ▾	Title Short ▾	Description ▾	Implementation Date ▾	
<input type="checkbox"/>		<input type="text"/>	<input type="text"/>	<input type="text"/>	<input type="text"/>	<input type="text"/>	<input type="text"/>	<input type="text"/>	<input type="text"/>
<input type="checkbox"/>		22197	Draft	Data collection in Vietn...	Luat Viet Nam	aaa	ssss	2019-07-25	999
<input type="checkbox"/>		2866	Complete	Data collection in Vietn...	Luat Viet Nam	01/2010/TT-BXD	Regulations for the qu...	2010-02-22	
<input type="checkbox"/>		22141	Complete	Data collection in Belar...	Consultant plus Datab...	Short Title	Description	2019-06-13	999
<input type="checkbox"/>		22132	Complete	Data collection in Belar...	Consultant plus Datab...	Short	Description	2019-06-06	999
<input type="checkbox"/>		22131	Complete	Data collection in Belar...	Consultant plus Datab...	Short Title	Description	2019-06-12	999
<input type="checkbox"/>		22120	Draft	Data collection in Belar...	Consultant plus Datab...	Demo title	Description	2019-06-05	999
<input type="checkbox"/>		22116	Draft	Antidumping measures		Short Title		2019-06-12	999
<input type="checkbox"/>		22099	Complete	Data collection in Belar...	Consultant plus Datab...	Titled	Description	2019-06-05	999
<input type="checkbox"/>		22097	Complete	Data collection in Belar...	Consultant plus Datab...	title	Description	2019-06-13	999
<input type="checkbox"/>		21872	Complete	Data collection in Sout...	The National Law Infor...	(Public notice of Minist...	이 고시는 수산자원관리...	2013-09-04	
<input type="checkbox"/>		22093	Complete	Data collection in Belar...	Consultant plus Datab...	Demo wish 1	Demo wish 1	2019-06-06	999
<input type="checkbox"/>		22090	Complete	Data collection in Brunei	Brunei Industrial Devel...	Short Title	Description	2019-06-05	999

Activate Windows



TRAINS Online Tool – Data Entry: Entry of Regulation

Regulation for Data collection in Vietnam

Source *

Luat Viet Nam + Source

Agencies *

Government of Vietnam + Agency

English Original Language

Short Title *

aaa

Regulation Symbol

Implementation Date *

7/25/2019 Repeal Date

English Original Language

Official Title *

ssss

English Original Language

Regulation Description *

ssss

Publication Date

7/16/2019

Language *

English

Publication Symbol

sss

Documentation* (Either upload a file or input a link in progress)

Drag and drop files or click here

Links

Add New Link

Notes

sss

Active Save as Draft Update Regulation

Go to Settings to activate Windows

TRAINS Online Tool – Data Entry: List of Measures

Measures

50 27 columns selected Select a bulk action Selection Only All Data

<input type="checkbox"/>		Id	State	Actions	Dataset Name	Nomenclature	NTM Code	Language	Original Language	Description	Implementation
<input type="checkbox"/>		<input type="text"/>	<input type="text"/>		<input type="text"/>	<input type="text"/>	<input type="text"/>	<input type="text"/>	<input type="text"/>	<input type="text"/>	<input type="text"/>
<input type="checkbox"/>		16017	Ready for publication		Data collection in Côte ...	M3	P500	English	French	Ordonnance portant b...	2009-11-26
<input type="checkbox"/>		16018	Ready for publication		Data collection in Côte ...	M3	P690	English	French	Normes de qualité et l...	1971-05-26
<input type="checkbox"/>		16019	Ready for publication		Data collection in Côte ...	M3	P290	English	French	Pour être admis à l'exp...	1973-07-09
<input type="checkbox"/>		16020	Ready for publication		Data collection in Côte ...	M3	P690	English	French	Le present arrêté défin...	1973-07-09
<input type="checkbox"/>		16021	Ready for publication		Data collection in Côte ...	M3	P690	English	French	Normes de qualité et l...	1968-05-09
<input type="checkbox"/>		16022	Ready for publication		Data collection in Côte ...	M3	P130	English	French	liste des bois et produi...	1991-01-02
<input type="checkbox"/>		16023	Ready for publication		Data collection in Côte ...	M3	A210	English	French	Normes de Teneurs en...	1996-05-22
<input type="checkbox"/>		16024	Ready for publication		Data collection in Côte ...	M3	B110	English	French	L'importation, la fabric...	2004-06-21
<input type="checkbox"/>		16025	Ready for publication		Data collection in Côte ...	M3	A190	English	French	Prohibition pour l'imp...	1963-12-10
<input type="checkbox"/>		16026	Ready for publication		Data collection in Côte ...	M3	A140	English	French	Autorisation d'importa...	1963-12-10
<input type="checkbox"/>		16027	Ready for publication		Data collection in Côte ...	M3	A830	English	French	L'importation de maté...	1963-12-10
<input type="checkbox"/>		16028	Ready for publication		Data collection in Côte ...	M3	A860	English	French	Quarantaine obligatoir...	1963-12-10
<input type="checkbox"/>		16029	Ready for publication		Data collection in Côte ...	M3	A190	English	French	Prohibition d'importati...	1963-12-10
<input type="checkbox"/>		16030	Ready for publication		Data collection in Côte ...	M3	A140	English	French	Permis d'importation d...	1963-12-10
<input type="checkbox"/>		16031	Ready for publication		Data collection in Côte ...	M3	A840	English	French	Inspection d'importati...	1963-12-10



TRAINS Online Tool – Data Entry: Entry of Measures



Measure for Data collection in Côte d'Ivoire

Lead Regulation *
ANNEXE FISCALE A L'ORDONNANCE N° 2009-382 DU 26 NOVEMBRE 2009 PORTANT BUDGET DE L'ETAT POUR LA GESTION 2010

Supporting Regulations

Measure Classification

English Original Language

Description *
Ordonnance portant budget de l'Etat pour la gestion 2010 portant extension du champ d'application du droit d'enregistrement aux

NTM Code *
P500 - Export taxes and charges

Domestic:
 Yes No Not Specified

Location(s) in the Regulation *

Implementation Date *
11/26/2009

Repeal Date

Only in free trade zone

Notes

Affected Countries

Description *
All Countries

Add Country / Country Group Create own country group

Countries
World Implementation Date Repeal Date : Include

Save as Draft Duplicate Measure Update Measure



TRAINS Online Tool – Data Entry: Entry of Product Code

Objectives

Description *

Taxes et charges d'exportation

Objective Codes *

X

Products

<

English

Original Language

>

Affected Products *

Cola, coton, karité, anacarde

Horizontal Measure



Drag and drop files
or click here

Product Coding

Save as Draft

Duplicate Measure

Update Measure

